

DENTAL

INSTRUMENTS

*High Quality
Instruments*

Extraction Sets
Extracting Forceps
Root Elevators
Bone Rongeurs
Orthodontic Pliers
Scalers
Impression Trays



 : Street Khojian Wali,
Mandranwala, Daska
Sialkot Pakistan.

 : 0092 311 0545662

Cell: 0092 349 5270053

 : salesribsinternational@gmail.com

 : www.ribsintl.com

01



EXTRACTING FORCEPS

Page # 01 - 14

02



ROOT ELEVATORS

Page # 15 - 29

03



**DIAGNOSTIC, PROBES, SCALERS, FILLING
& LABORATORY INSTRUMENTS**

Page # 30 - 77

04



**MAXILLOFACIAL SURGERY
INSTRUMENTS**

Page # 78 - 95

05



**ORTHODONTIC INSTRUMENTS
& PLIERS**

Page # 96 - 107

06



DENTAL IMPLANT INSTRUMENTS

Page # 108 - 142

07

impression Tray & Hollow wares

Page # 143 - 148



EXTRACTING FORCEPS

HANDLE GRIP AVAILABLE
A, B, C, D

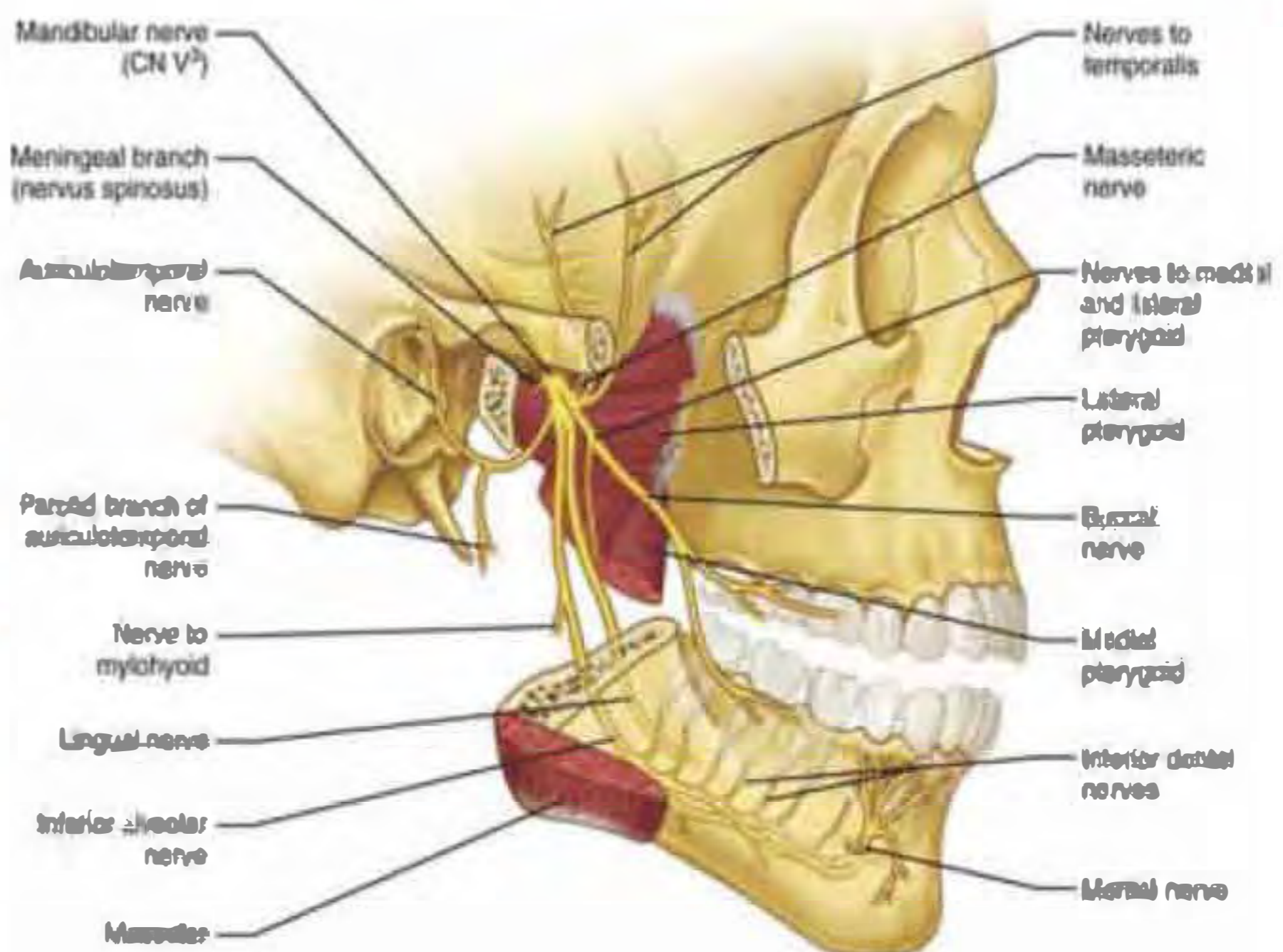
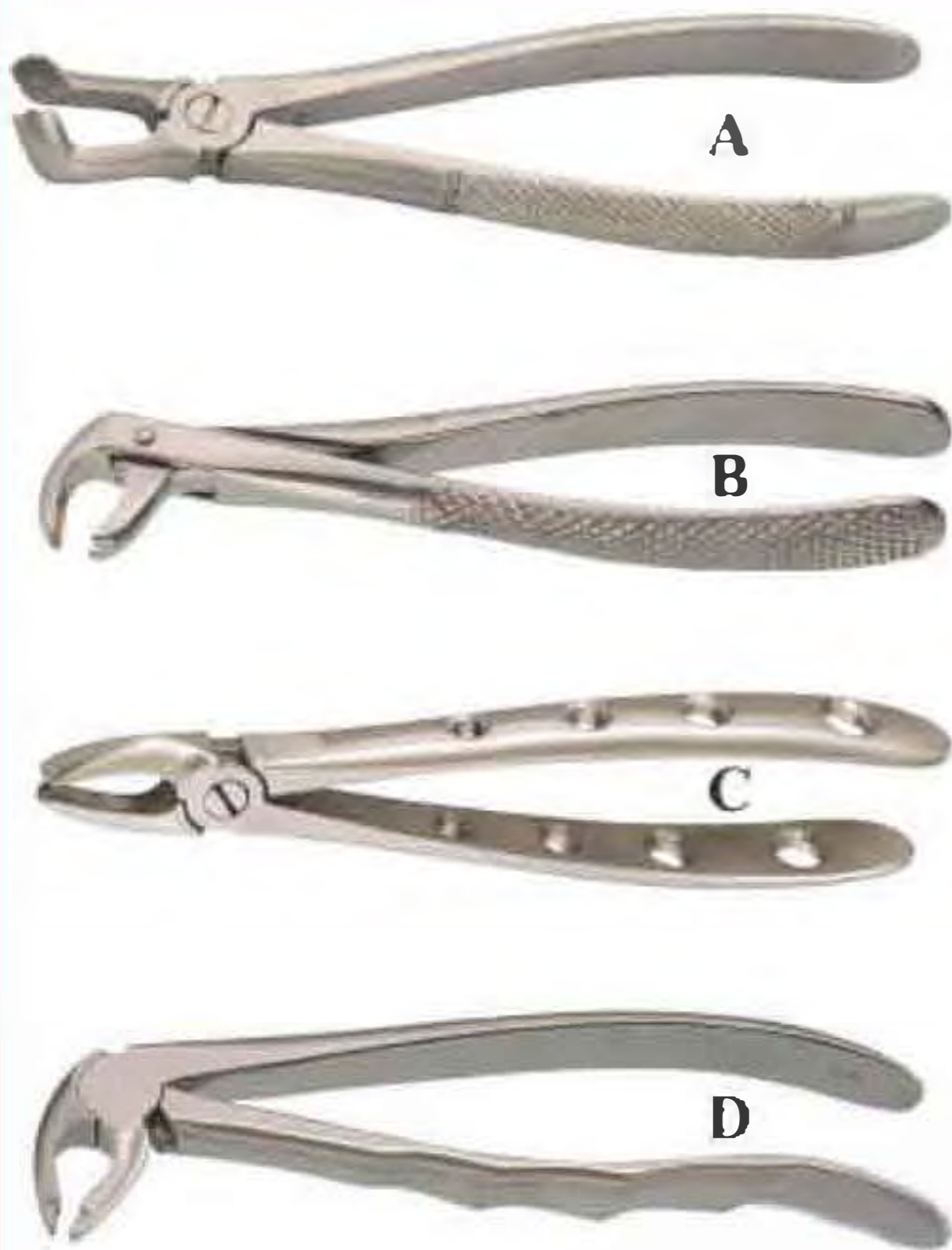

EXTRACTING FORCEPS (English Pattern)

- Шипцы экстракционные (английская форма)
- Daviers (Forme Anglaise)
- Zahnzangen (Englische Form)

- Шипці екстракційні (англійська форма)
- Forceps de Extracción (Forme Inglesa)
- استخراج الملعط (نمط اللغة الإنجليزية)



DE-001
Fig. 23
Syndesmotome lower roots



DE-002
Fig. 24
Syndesmotome upper molar



DE-003
Fig. 25
Syndesmotome Lower molar forceps



DE-004
Fig. 79
Lower Wisdoms



DE-005
Fig. 60
Upper roots, extra slim jaws



DE-006
Fig. 62
Upper roots, extra slim jaws



DE-007
Fig. 74
Upper roots and incisors



DE-008
Fig. 33
Lower Roots



DE-009
Fig. 51
Upper Roots



DE-010
Fig. 61
upper Roots, short,
extra slim jaws



DE-011
Fig. 67
upper wisdoms,
either sides



DE-012
Fig. 86
lower molars decayed or
with broken down crown

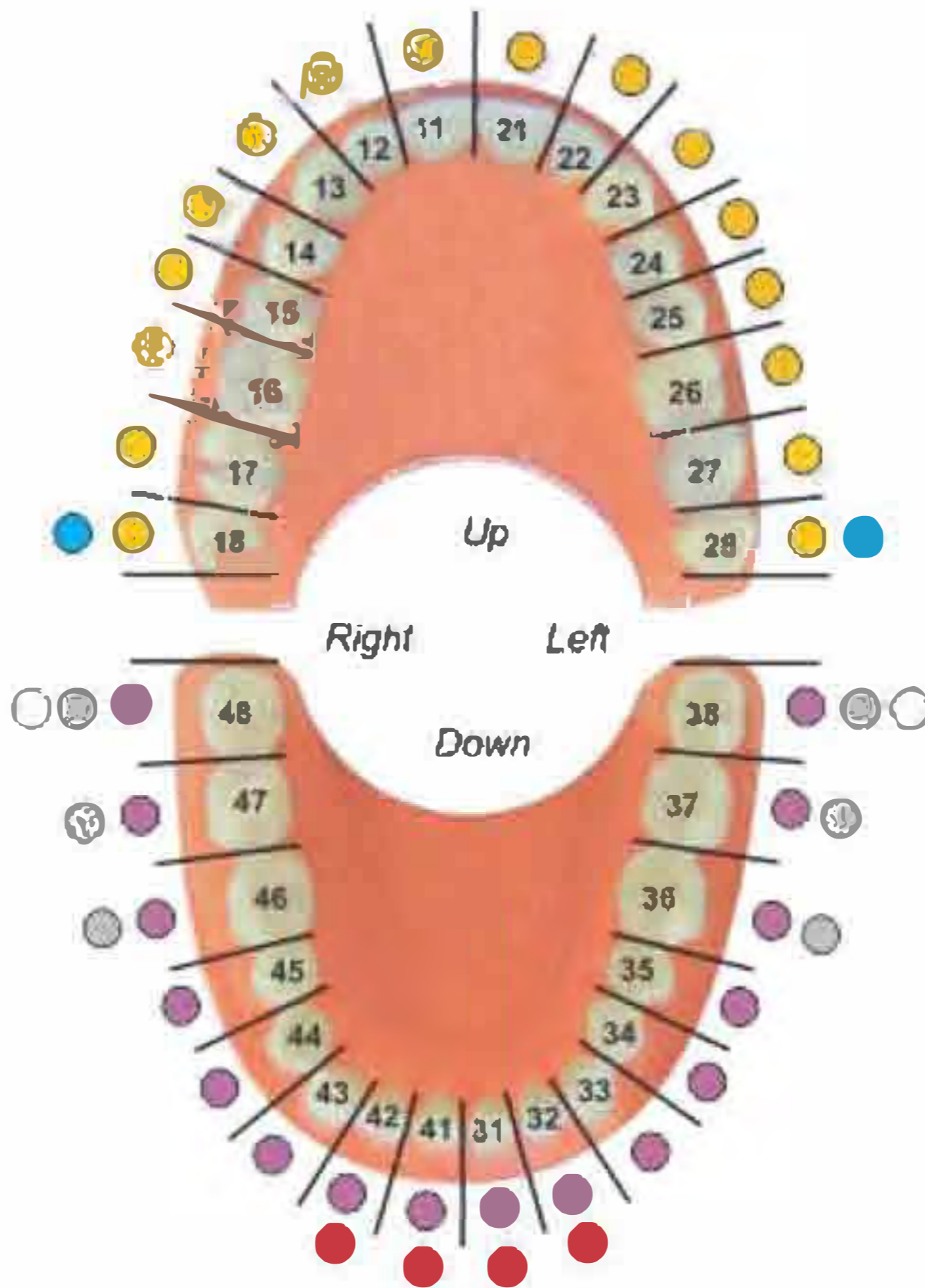

EXTRACTING FORCEPS (English Pattern)

- Щипцы экстракционные (английская форма)
- Daviers (Forme Anglaise)
- Zahnzangen (Englische Form)

- Щипці екстракційні (англійська форма)
- Forceps de Extracció (Forme Inglesa)
- استخراج المعلق (نمط فائدة الإنجليزية)



DE-013
Fig. 01
upper centrals and canines



DE-014
Fig. 04
Lower Incisors and Canines



DE-015
Fig. 08
Lower Bicuspid



DE-016
Fig. 17
Upper right molars



DE-017
Fig. 73
Lower molars



DE-018
Fig. 21
Lower molars



DE-019
Fig. 02
upper Incisors and canines



DE-020
Fig. 07
Lower Canines and bicuspid



Lower Canines and bicuspid



DE-022
Fig. 18
Upper Left Molars



DE-023
Fig. 22
Lower molars - Untere Molaren



DE-024
Fig. 75
Lower canines and bicuspid

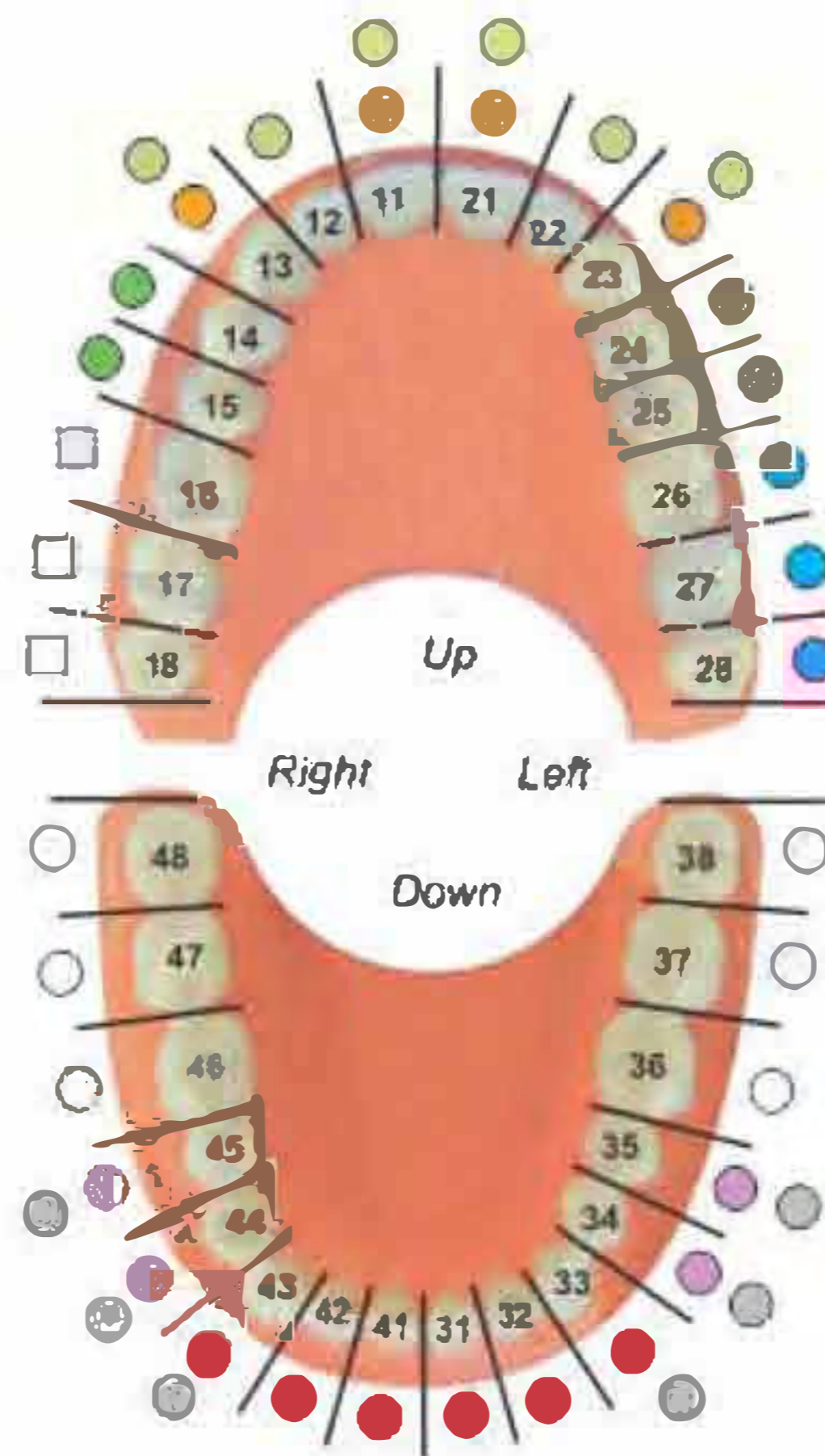

EXTRACTING FORCEPS (English Pattern)

- Ципцы экстракционные (английская форма)
- Daviers (Forme Anglaise)
- Zahnzangen (Englische Form)

- Щипці екстракційні (англійська форма)
- Forceps de Extracción (Forme Inglesa)
- استخراج الحظوظ (نمط اللغة الانجليزية)

Apical Set of 9 Pcs (Deep Gripe Extracting Forceps)



- No Fracture
- No Tissue Damage
- Extraction With Easy

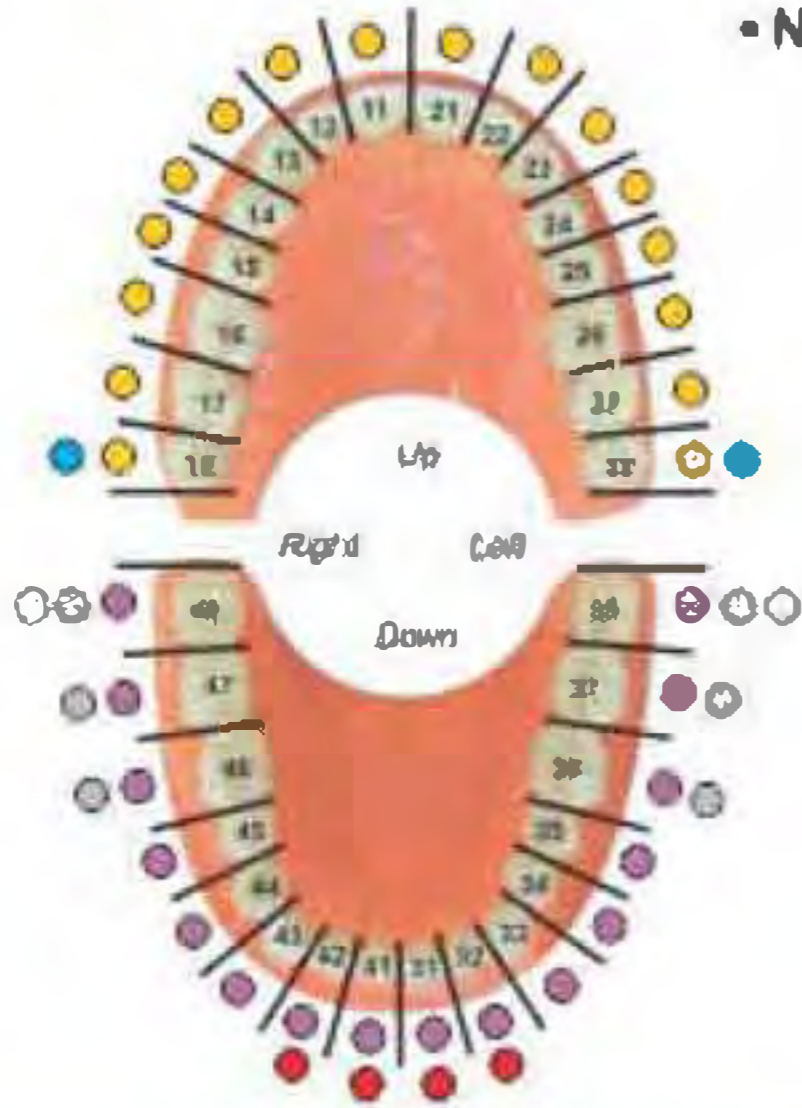

Thin Tip

DE-029
F-2
LOWER UNIVERSAL

Wide Tip

DE-030
F-4
LOWER ANTERIOR

Thin Tip

DE-025
F-1
UPPER UNIVERSAL

DE-031
F-4
LOWER ANTERIOR

Wide Tip

DE-026
F-1
UPPER UNIVERSAL

DE-032
F-6
UPPER 3RD

Thin Tip

DE-027
F-3
UPPER ANTERIOR

DE-033
F-7C
LOWER MOLAR

Wide Tip

DE-028
F-3
UPPER ANTERIOR

A-TRAUMATIC EXTRACTION SET

Improved tapered beaks for complete root contact. Cross serrations for a never slip grasp. Easily enter the subgingival.

EXTRACTING FORCEPS (English Pattern)

- Щипцы экстракционные (английская форма)
- Daviers (Forme Anglaise)
- Zahnzangen (Englische Form)
- Щипці екстракційні (англійська форма)
- Forcèps de Extracció (Forme Inglesa)
- استخراج المنقط (نمط اللغة الإنجليزية)



Fig. 79A



Fig. 45Z



Fig. 51Z



Fig. 44Z



Fig. 46



Fig. 67



Fig. 67A



Fig. 79



DE-034
Fig. 9
Apex Forceps Lower Universal
Deep Root Pick



DE-035
Fig. 187
Apex Forceps Lower Root
Deep Root Pick



DE-036
Fig. 189
Apex Forceps
Upper Root
Deep Root Pick



DE-037
Fig. 190
Apex Forceps Upper Root
Deep Root Pick



DE-038
Fig. 46XL
Apex Forceps Lower Root
Deep Root Pick

DEEP ROOT PICK FORCEPS (Apical Set of 9)

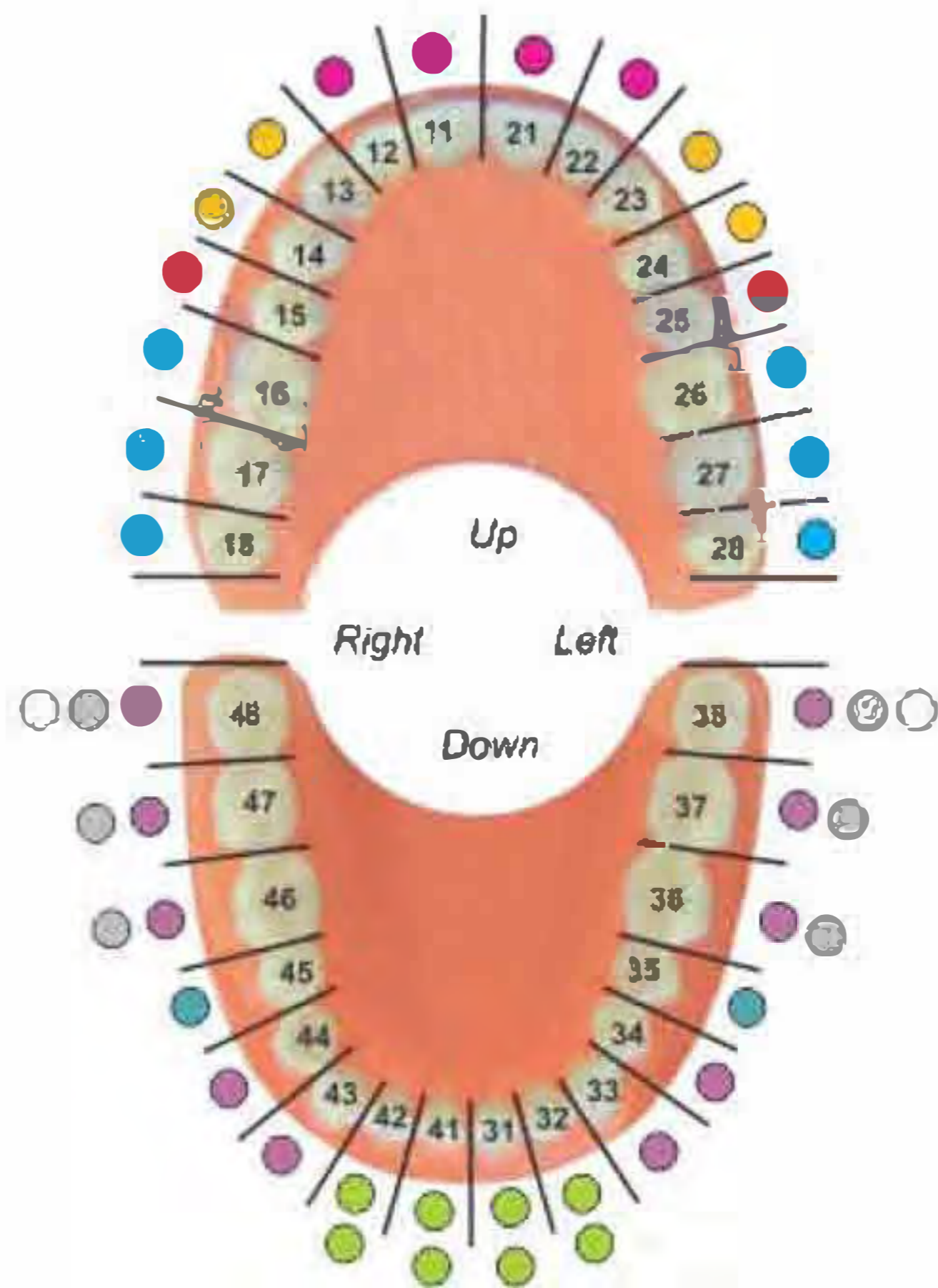

DE-039
Fig. 67
Upper Thrid Molars



DE-040
Fig. 67A
Upper Thrid Molars



DE-041
Fig. 79
Lower Thrid Molars



DE-042
Fig. 37
Lower Root Molars

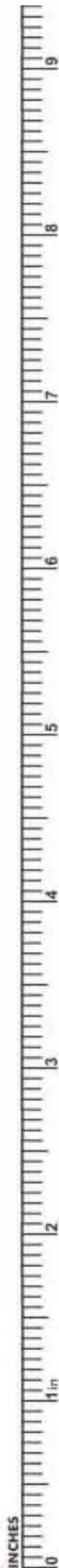

EXTRACTING FORCEPS (English Pattern)

- Щипцы экстракционные (английская форма)
- Daviers (Forme Anglaise)
- Zahnzangen (Englische Form)

- Щипці екстракційні (англійська форма)
- Forceps de Extracción (Forme Inglesa)
- امستخرج المنطق (نمط اللغة الانجليزية)



DE-043
Fig. 2
upper laterals and canines



DE-044
Fig. 7
Upper Premolars/Bicuspids



DE-045
Fig. 17
Upper Molars, Right



DE-046
Fig. 18
Upper Molars, Left



DE-047
Fig. 67
upper third molars



DE-048
Fig. 13
Lower Premolars/
Bicuspids



DE-049
Fig. 22
Lower Molars



DE-050
Fig. 33
lower roots



DE-051
Fig. 51
upper roots



DE-052
Fig. 79
Lower third molars

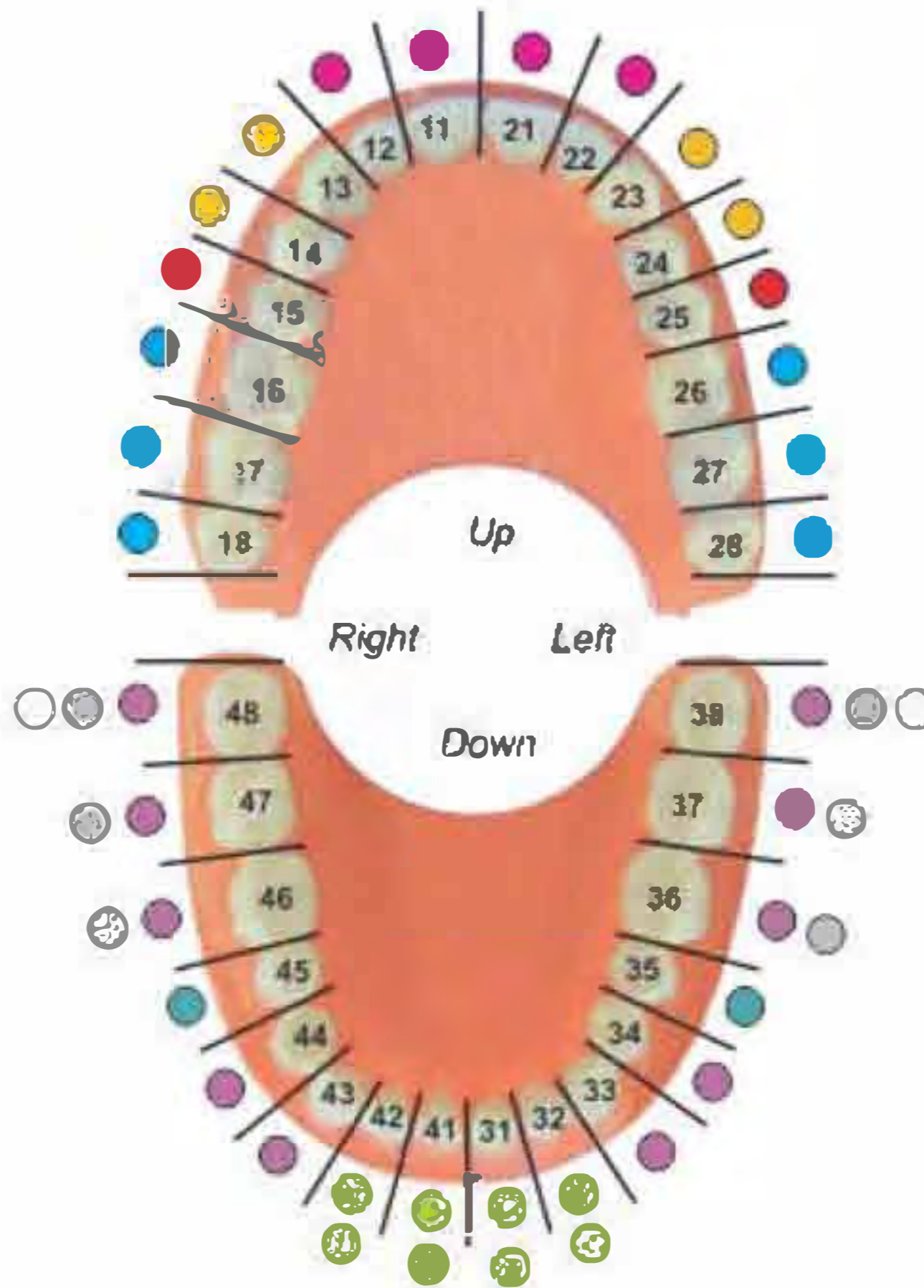

EXTRACTING FORCEPS (English Pattern)

- Щипцы экстракционные (английская форма)
- Daviers (Forme Anglaise)
- Zahnzangen (Englische Form)
- Щипці екстракційні (англійська форма)
- Forceps de Extracción (Forme Inglesa)
- استخراج الملقط (نمط اللغة الإنجليزية)



DE-053
Fig. 1
upper laterals
and canines



Extracting Forceps
Set of 10 Pcs
Detail of Pack
Forceps
Fig. 1
Fig. 2
Fig. 73
Fig. 67
Fig. 51A
Fig. 74
Fig. 51
Fig. 17
Fig. 7
Fig. 13



DE-058
74
lower roots



DE-054
2
upper laterals
and canines



DE-059
51
upper roots



DE-055
73
lower molars

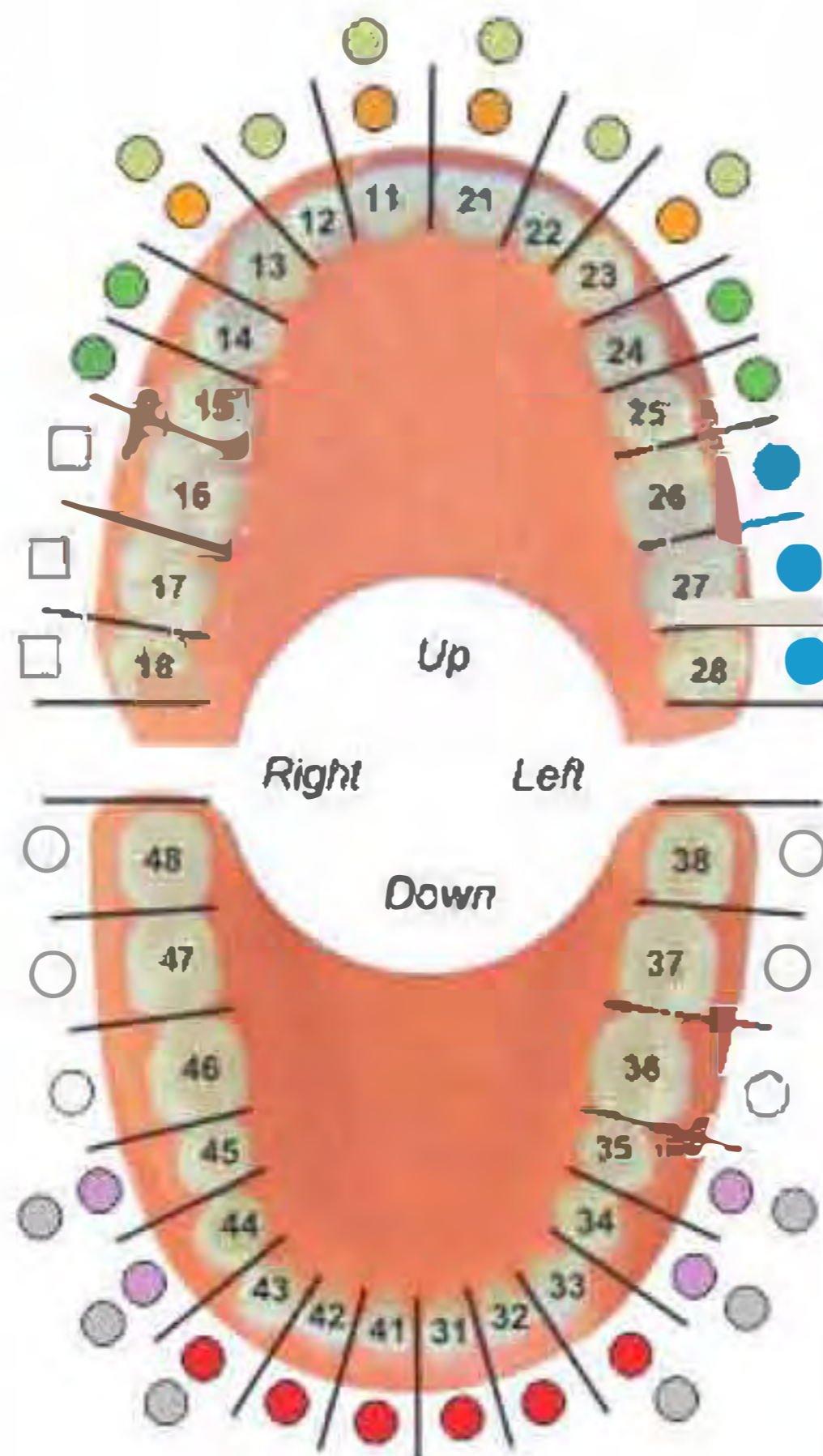

DE-060
17
upper molars,
right



DE-056
87
upper third
molars



DE-061
7
upper premolars



DE-057
51 A
upper roots



DE-062
13
lower premolars

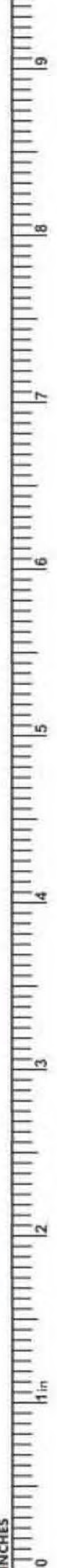

EXTRACTING FORCEPS (English Pattern)

- Щипцы экстракционные (английская форма)
- Daviers (Fonne Anglaise)
- Zahnzangen (Englische Form)

- Щипці екстракційні (англійська форма)
- Forceps de Extracción (Forme Inglesa)
- امستخرج المنطق (نمط اللغة الانجليزية)

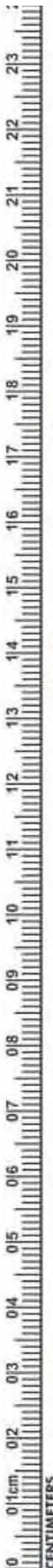

Set of 10 Pieces
Fig. 1
Fig. 7
Fig. 13
Fig. 17
Fig. 18
Fig. 22
Fig. 33A
Fig. 51A
Fig. 67A
Fig. 79



DE-063
Fig. 1
Upper Centrals
& Canines/Cuspids



DE-064
Fig. 7
Upper Premolars/
Bicuspid



DE-065
Fig. 13
Lower Premolars/
Bicuspid



DE-066
Fig. 17
Upper Molars,
Right



DE-067
Fig. 18
Upper Molars,
Left

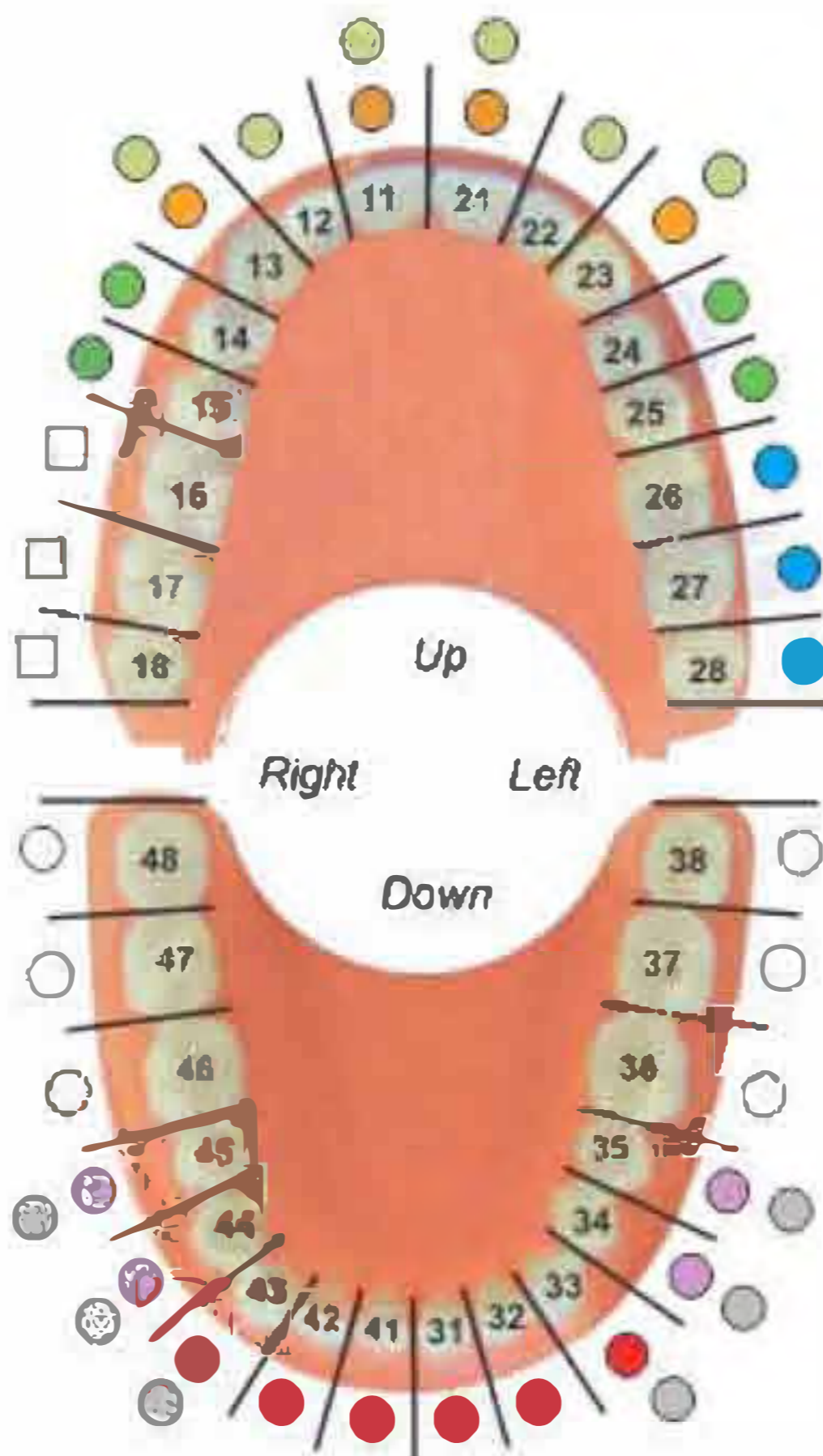

DE-068
Fig. 22
Lower Molars



DE-069
Fig. 33A
Lower Roots
Narrow tips



DE-070
Fig. 51A
Upper roots
narrow tips



DE-071
Fig. 67A
Upper third
molars



DE-072
Fig. 79
Lower third
molars

EXTRACTING FORCEPS

- Щипцы экстракционные
- Daviers
- Zahnzangen
- Щипцы экстракційні
- Forceps de Extracción
- سنطراج المنطق

Pediatric Tooth Extracting Forceps Set



DE-074
English Pattern Klein #51S
Pedodontic Upper root



DE-073
English Pattern Klein #137
Pedodontic, Upper Incisors
Spring handle



DE-077
English Pattern Klein #5
Pedodontic Lower Incisors.



DE-075
English Pattern Klein #139
Pedodontic Upper Premolars



Fig. # 01 to 07
Set of 7 Pieces



DE-078
English Pattern Klein #7
Pedodontic Lower Roots,



DE-076
English Pattern Klein #3
Pedodontic Upper Molars
Universal

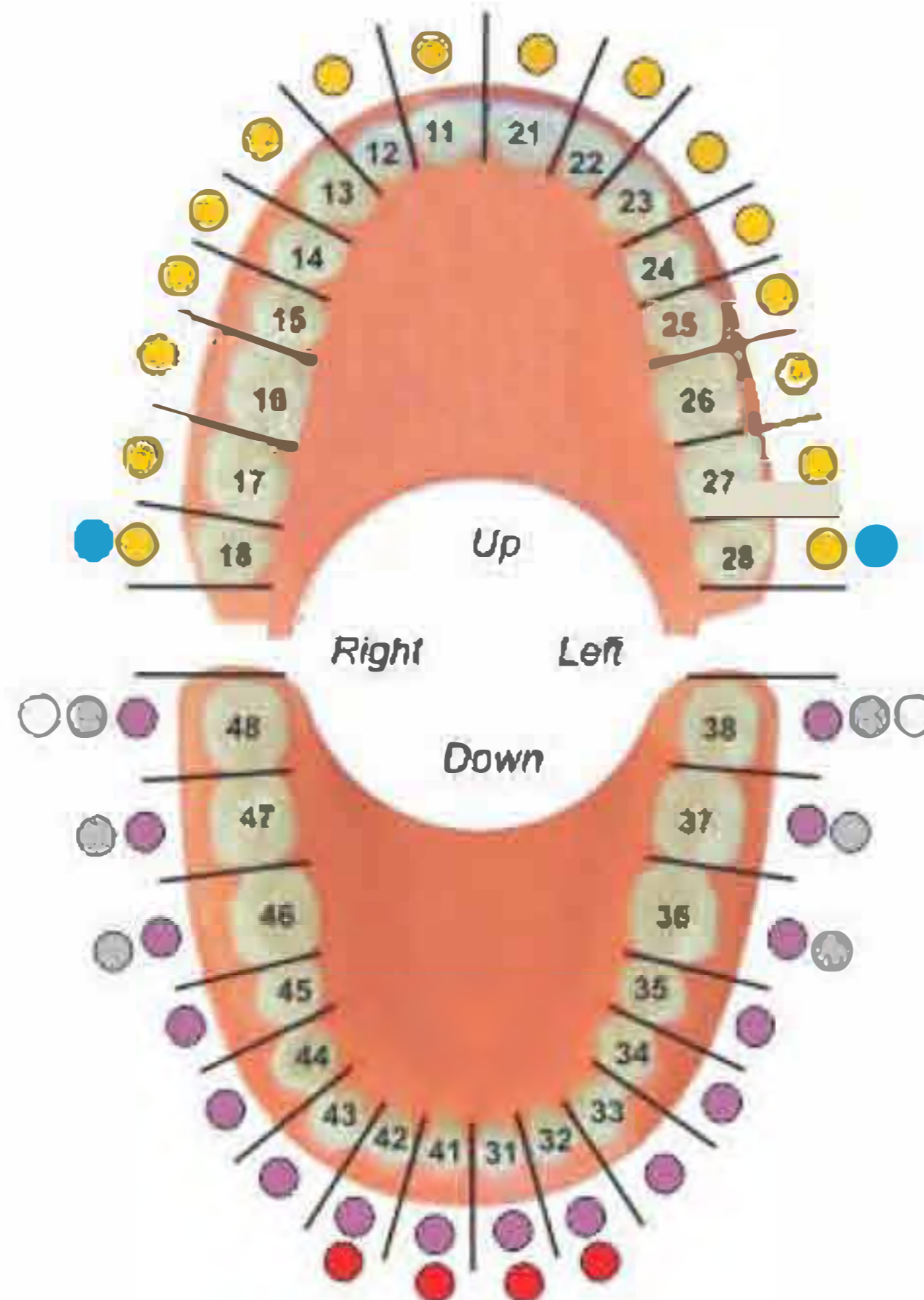

DE-079
English Pattern Klein #6
Pedodontic Lower Molars,
Spring Handle

INCHES
0 1 2 3 4 5 6 7 8 9

- Ципцы экстракционные
 - Daviers
 - Zahnzangen
- اذني استخراجية
 - Forceps de Extracción
 - استخراج الملقط



DE-080
Fig. 17 SK
Lower molars



DE-081
Fig. 150 SK
Upper anteriors and roots



DE-082
Fig. 151 SK
lower anteriors and roots



DE-083
Fig. 90
Upper molars, left



DE-084
Fig. 17S
Lower, molars



DE-085
Fig. 18LS
upper, molars left



DE-086
Fig. 18RS
upper, molars right



DE-087
Fig. 65S
upper incisors and roots



DE-088
Fig. 69S
upper and lower roots

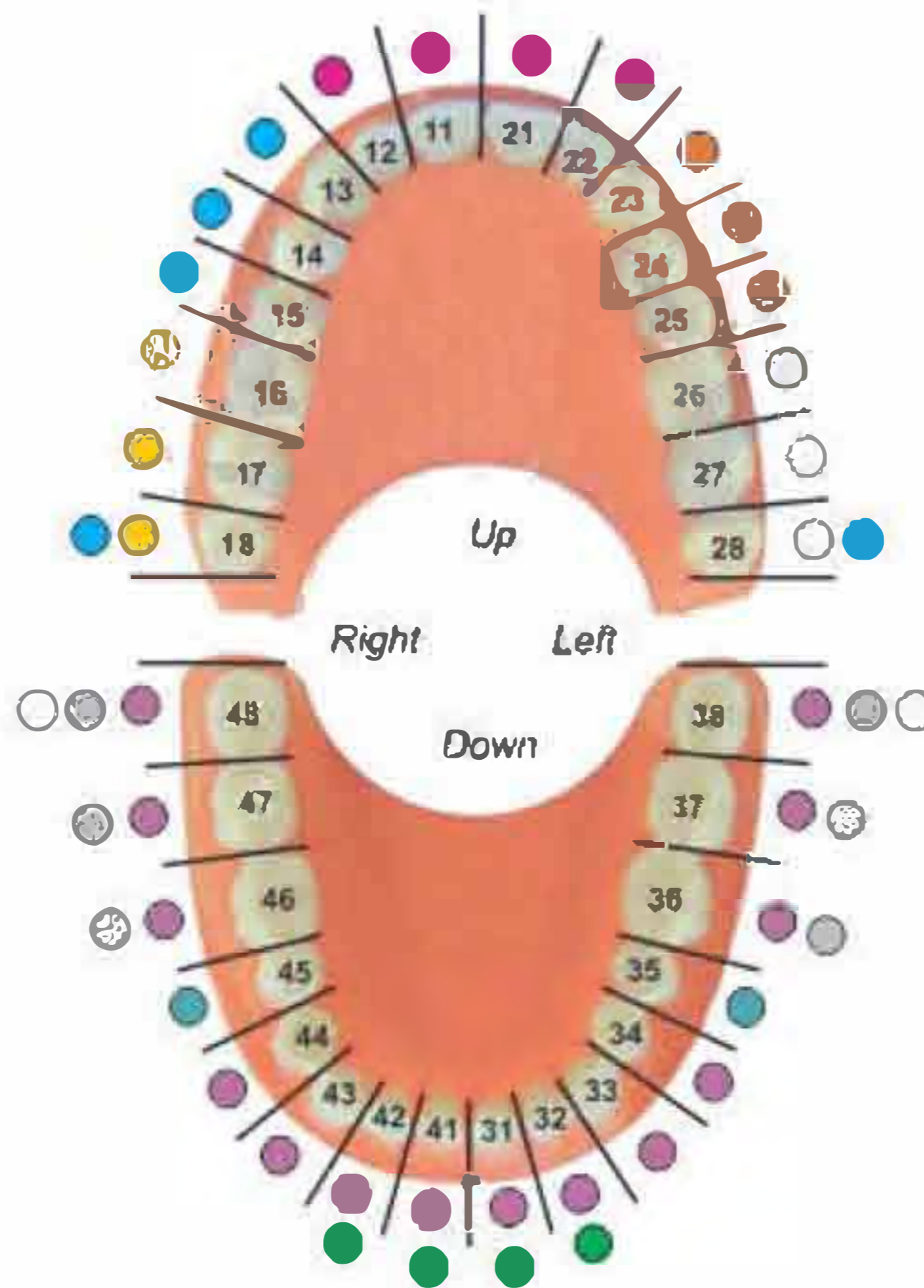

EXTRACTING FORCEPS (American Pattern)

- Щипцы экстракционные (американская форма)
- Daviers - forme américaine
- Férseps de extracción - forma americana
- Щипці екстракційні (американська форма)
- Pinzere per estrazione - forma americana
- مستخرج الملقط (النمط الأمريكي)

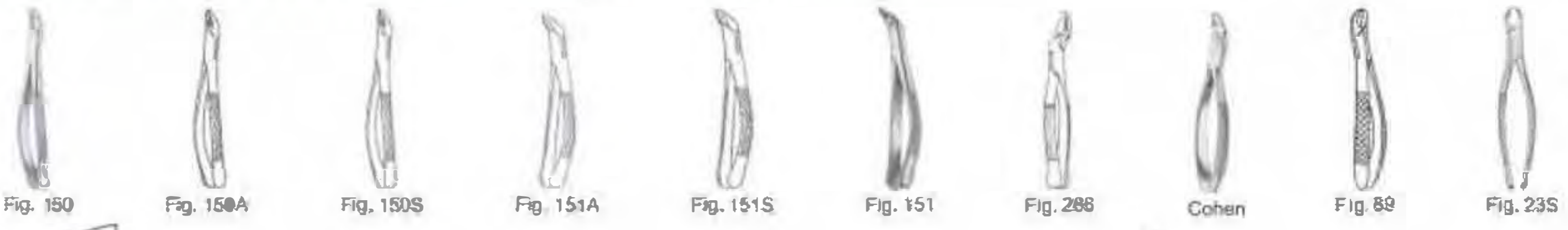

DE-089
150
Cryer upper incisors, premolars, roots



DE-090
150A
Cryer upper incisors, premolars, roots



DE-091
150S
Cryer upper teeth, for children



DE-092
151A
Cryer lower incisors, premolars, roots



DE-093
151 S
Cryer lower incisors, premolars, roots



DE-094
151
Cryer lower teeth, for children



DE-095
286
upper incisors and roots



DE-096
Cohen universal forceps



DE-097
89
Upper molars, right



DE-098
23 S
Lower molars

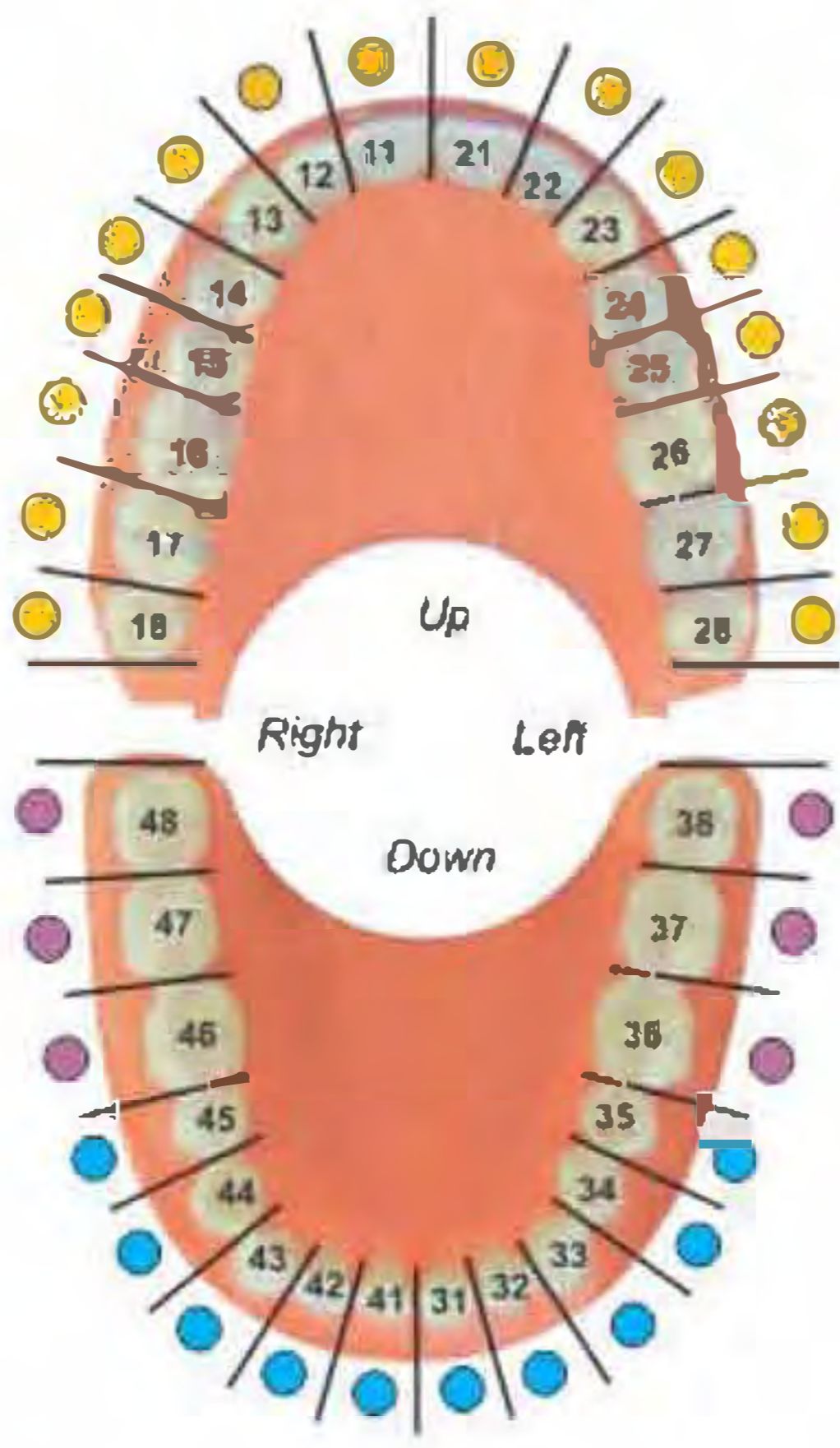

EXTRACTING FORCEPS (American Pattern)

- Щипцы экстракционные (американская форма)
- Daviers - forme américaine
- Fórceps de extracción - forma americana

- Щипці екстракційні (американська форма)
- Pinzette per estrazione - forma americana
- استخراج قواطع (النمط الأمريكي)



Fig. 2



Fig. 4



Fig. 7



Fig. 13



Fig. 17



Fig. 18 L



Fig. 18 R



Fig. 29 S



Fig. 35



Cohen



DE-099
2
upper and lower roots



DE-100
4
upper and lower premolars



DE-101
7
upper roots



DE-102
13
upper incisors



DE-103
17
lower molars



DE-104
18 L
Harris upper molars, left



DE-105
18 R
Harris upper molars, right



DE-106
29 S
lower teeth, for children



DE-107
35
upper roots



DE-108
Cohen
universal forceps

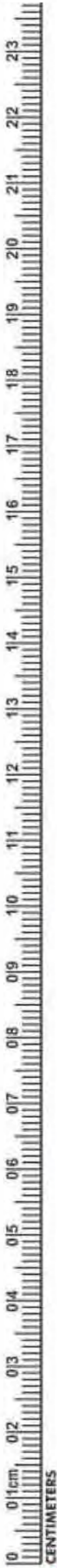
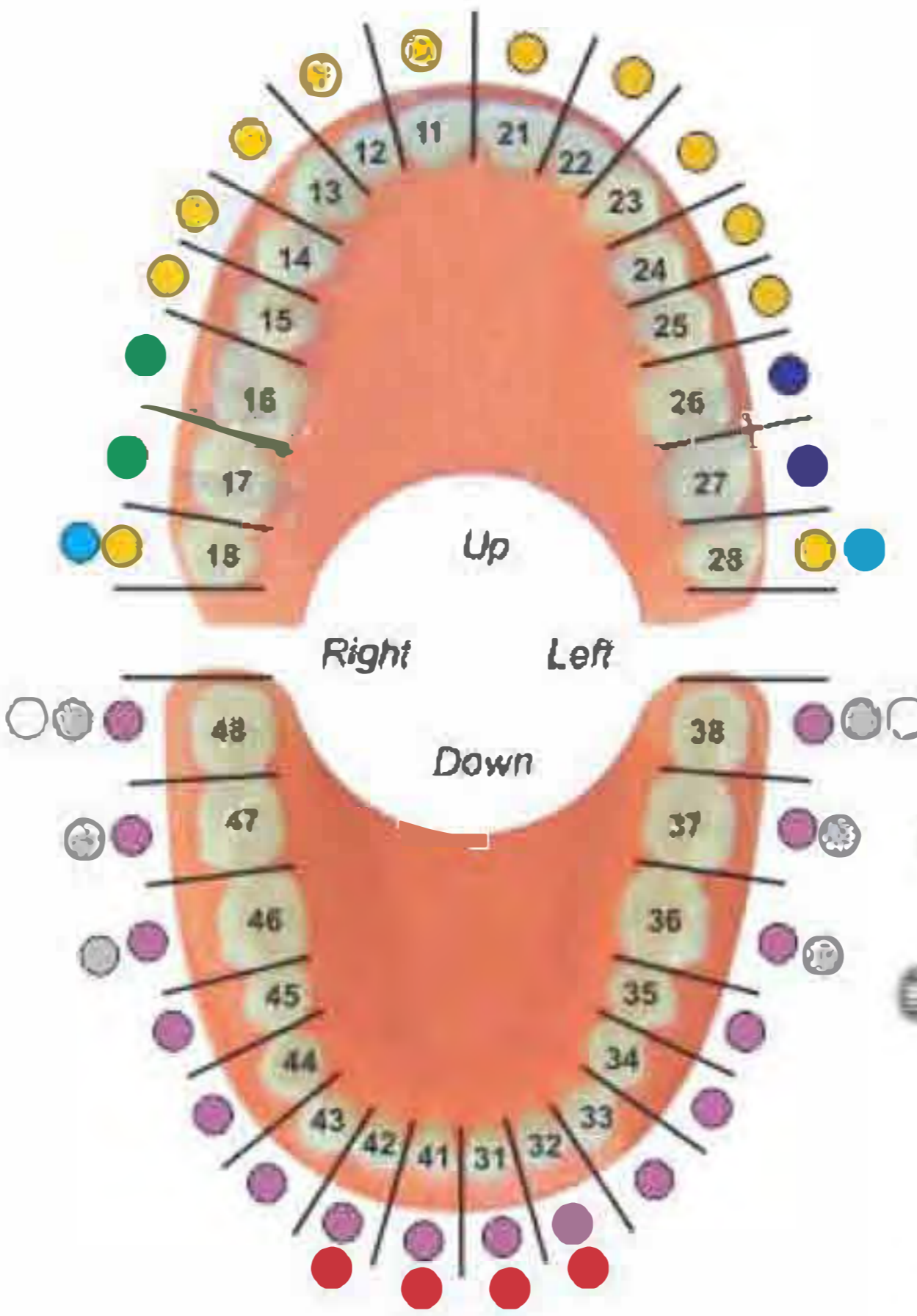

EXTRACTING FORCEPS (American Pattern)

- Щипцы экстракционные (американская форма)
- Daviers - forme américaine
- Fórceps de extracción - forma americana
- Щипці екстракційні (американська форма)
- Pinzette per estrazione - forma americana
- مخرجات المنطق (النمط الأمريكي)



DE-109
Fig. 1
Upper Anterior

DE-110
Lower Molar
Fig. 23 Cow Horn



DE-111
Fig. 74
Lower Anterior



DE-112
Fig. 88L
Upper Molar Left



DE-113
Fig. 88R
Upper Molar Right



DE-114
Fig. 74
Lower Anterior



DE-115
Fig. 106
Lower Incisors



DE-116
Fig. 174
Extra Narrow
Lower Anterior
Apical Retention
Forceps



DE-117
Fig. 859
Lower Molars
Roots



- Шприцы стоматологические карпульные
- Seringues à usage dentaire
- Dentspritzen
- Шприці стоматологічні карпульні
- Jeringas dentales
- المحاقن الأسنان



DE-118 1.8ML
DE-119 2.2ML



DE-120 1.8ML
DE-121 2.2ML



DE-122 1.8ML
DE-123 2.2ML



DE-124 1.8ML
DE-125 2.2ML



DE-126 1.8ML
DE-127 2.2ML



DE-128 1.8ML
DE-129 2.2ML



DE-130
1001
Intrallgamental
Anesthesia Syringe
in Black Colour



DE-131 1.8ML
DE-132 2.2ML
Angled



DE-133
Aluminium



DE-134
Aluminium - Silver 1.8 ml



DE-135
Aluminium - Orange 1.8 ml



DE-136
Aluminium - Green 1.8 ml



DE-137
Aluminium - Blue 1.8 ml

BONE ROUNGER

- Костные кусачки
- Knochelzangen
- Pinces-ongues
- كساح عظام



DE-138
Blumenthal
15cm



DE-139
Blumenthal
15cm



DE-140
Blumenthal
15cm



DE-141
Friedman
14cm



DE-142
Friedman
14.5cm



DE-143
Micro-Friedman
14cm



DE-144
Micro-Friedman
15cm



DE-145
Micro-Friedman
16cm



DE-146
Kleinert-Kutz
18.5cm



DE-147
Beyer
18.5cm



DE-148
Mead 1A
18.5cm



DE-149
Luer
18.5cm



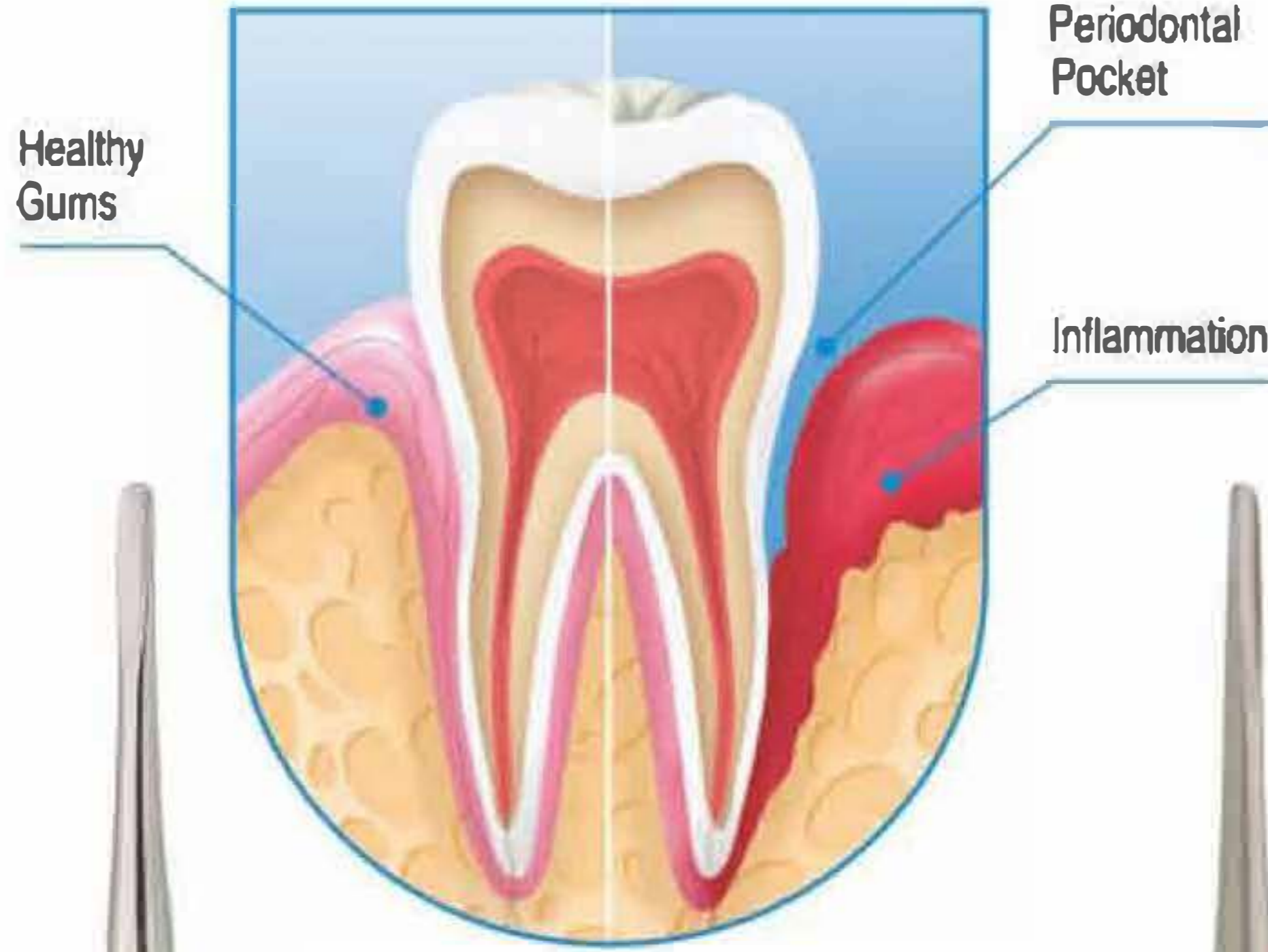

**HANDLES FOR ROOT ELEVATORS POINTS
A, B, C, D**

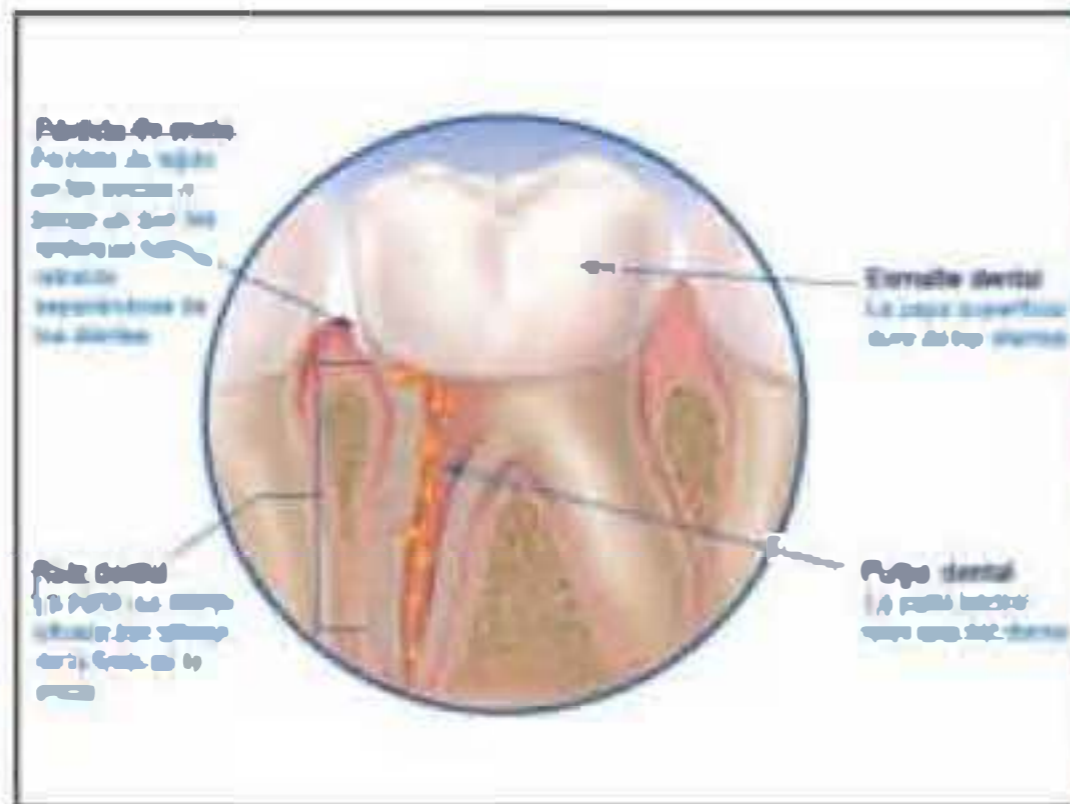

ROOT ELEVATOR

- Элеватор корневой экстракционный
- Elevateurs à racines
- Wurzelheber
- Elevator coronevii ekstraktsionnyy
- Elevadores para raíces
- المصاط تجزير

Apexo Root Elevators



Apexo



DE-150
Apexo
2.5x9mm
Straight



DE-151
Apexo
2.7x9mm
Straight



DE-152
Apexo
3.0x9mm
Straight



DE-153
Apexo
2.5x9mm
Curved



DE-154
Apexo
3.0x9mm
Curved



DE-155
Seldin
3.0x14mm
Straight

Luxator Root Elevators



Luxator



DE-156
Luxator
3mm
straight



DE-157
Luxator
3mm
curved



DE-158
Luxator
4mm
straight



DE-159
Luxator
4mm
curved



DE-160
Luxator
5mm
straight



DE-161
Luxator
5mm
curved

Bein Root Elevators



Bein



DE-162
Bein 2mm



DE-163
Bein 3mm

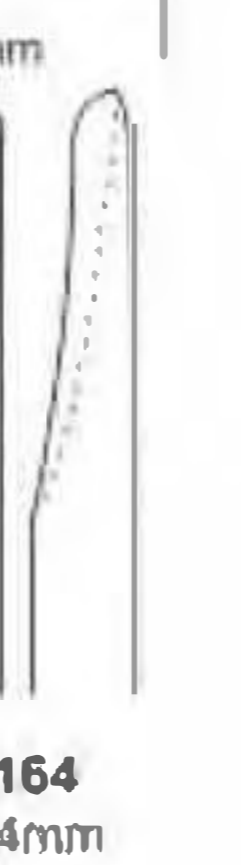

DE-164
Bein 4mm

Seldin Root Elevators



Seldin



DE-165
Flohr 1



DE-166
Seldin 34S

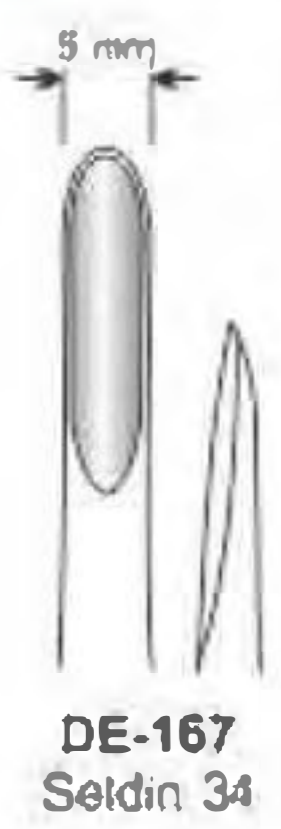

DE-167
Seldin 34



- Элеватор корневой экстракционный
- Elevator corneveeie extraeeiee
- Elévateurs à racines
- Elevadores para raíces
- Wurzelheber
- المصاعد الجذر

Apexo Root Elevators



Apexo



DE-168
Apexo
2.5x9mm
Straight



DE-169
Apexo
2.7x9mm
Straight



DE-170
Apexo
3.0x9mm
Straight



DE-171
Apexo
2.5x9mm
Curved



DE-172
Apexo
3.0x9mm
Curved



DE-173
Seldin
3.0x14mm
Straight

Luxator Root Elevators



Luxator



DE-174
Luxator
3mm
straight



DE-175
Luxator
3mm
curved



DE-176
Luxator
4mm
straight



DE-177
Luxator
4mm
curved



DE-178
Luxator
5mm
straight



DE-179
Luxator
5mm
curved

Bein Root Elevators



Bein



DE-180
Bein 2mm



DE-181
Bein 3mm



DE-182
Bein 4mm

Seldin Root Elevators



Seldin



DE-183
Flohr 1



DE-184
Seldin 34S



DE-185
Seldin 34



ROOT ELEVATOR

- Элеватор корневой экстракционный
- Elevateurs à racines
- Wurzelheber
- Elevator morvnyy ekstraktsionnyy
- Elevadores para raíces
- المصاعد الجذر

Apical Root Elevators

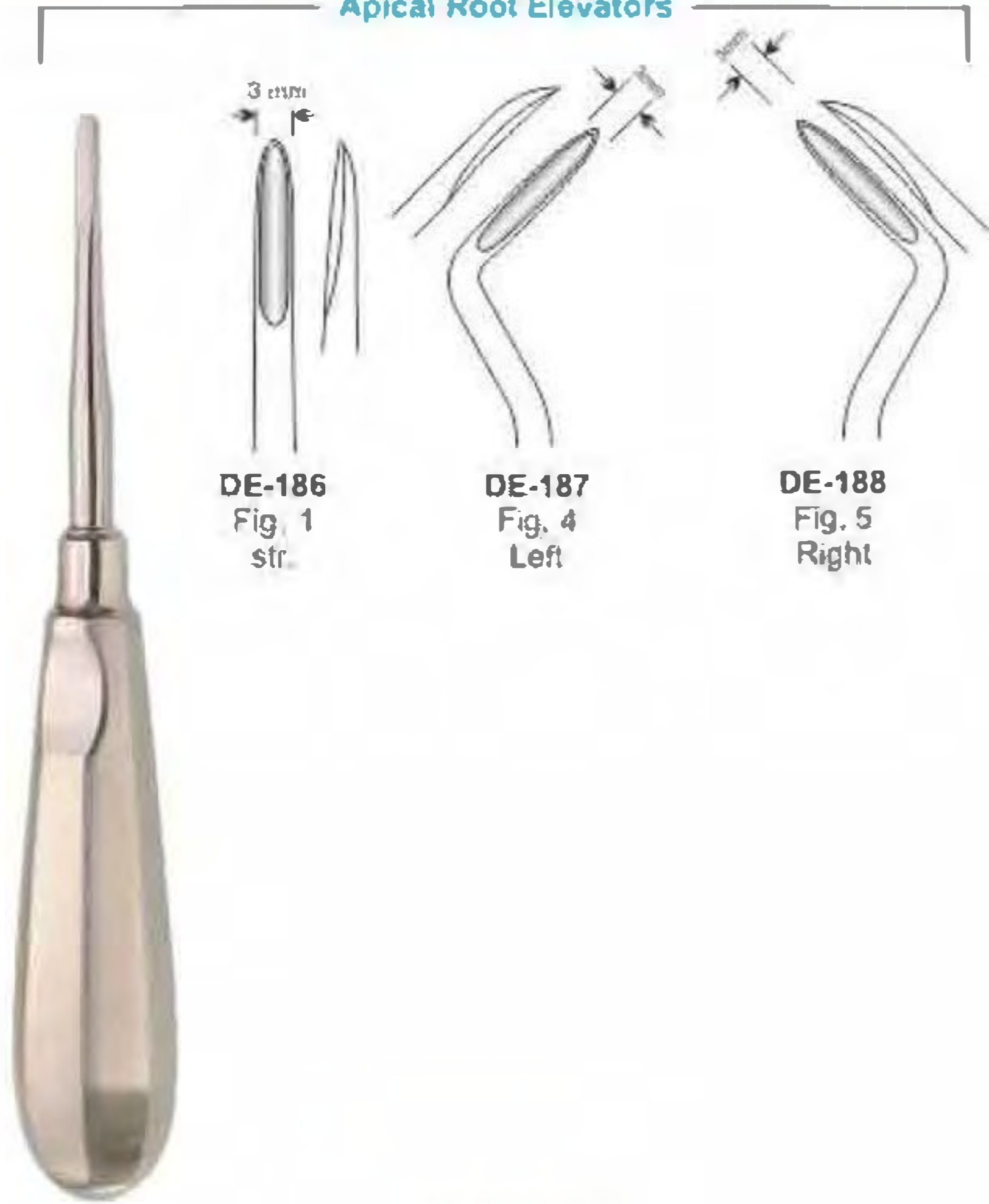

Apical Root Elevators

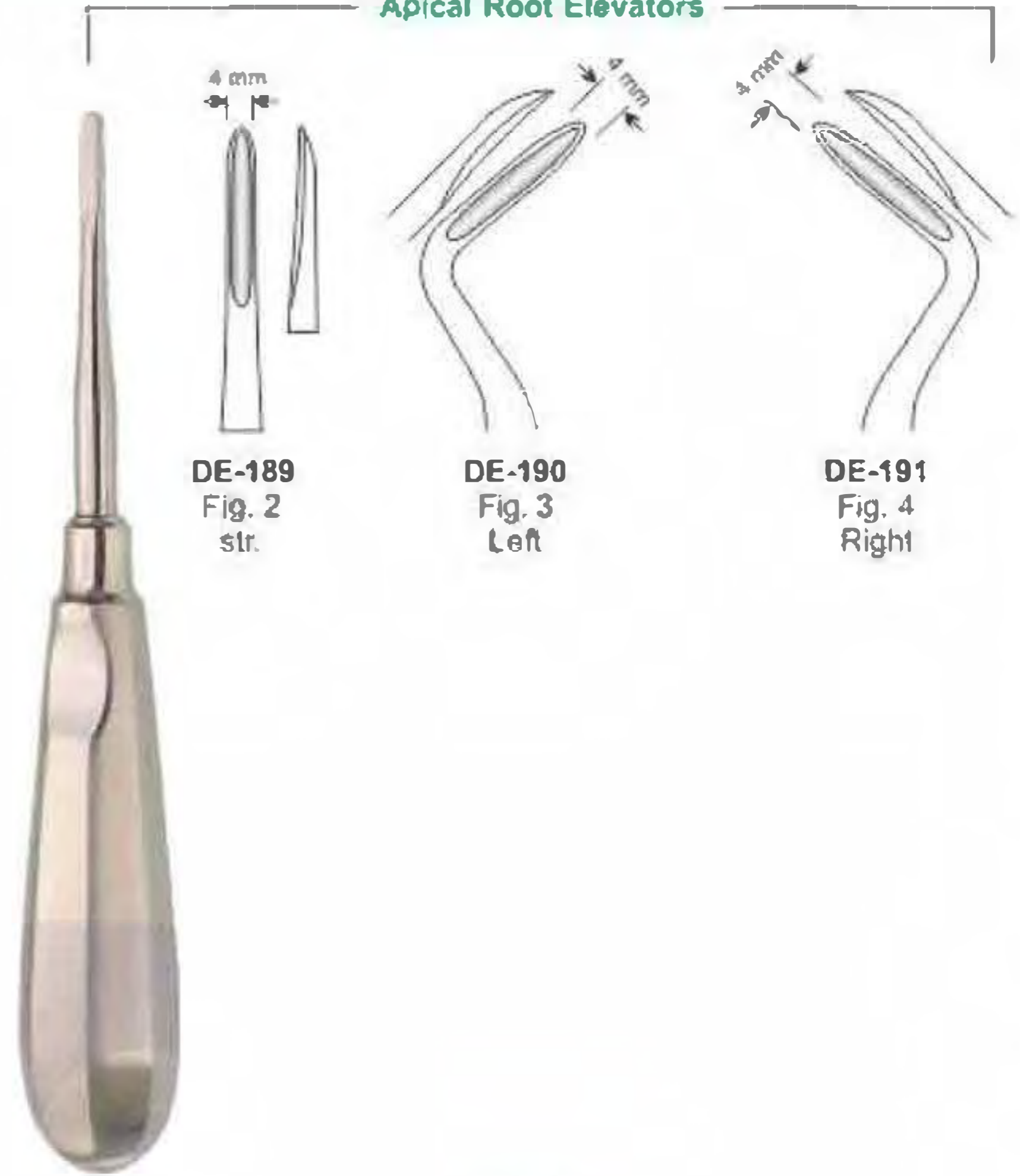

Coupland Root Elevators

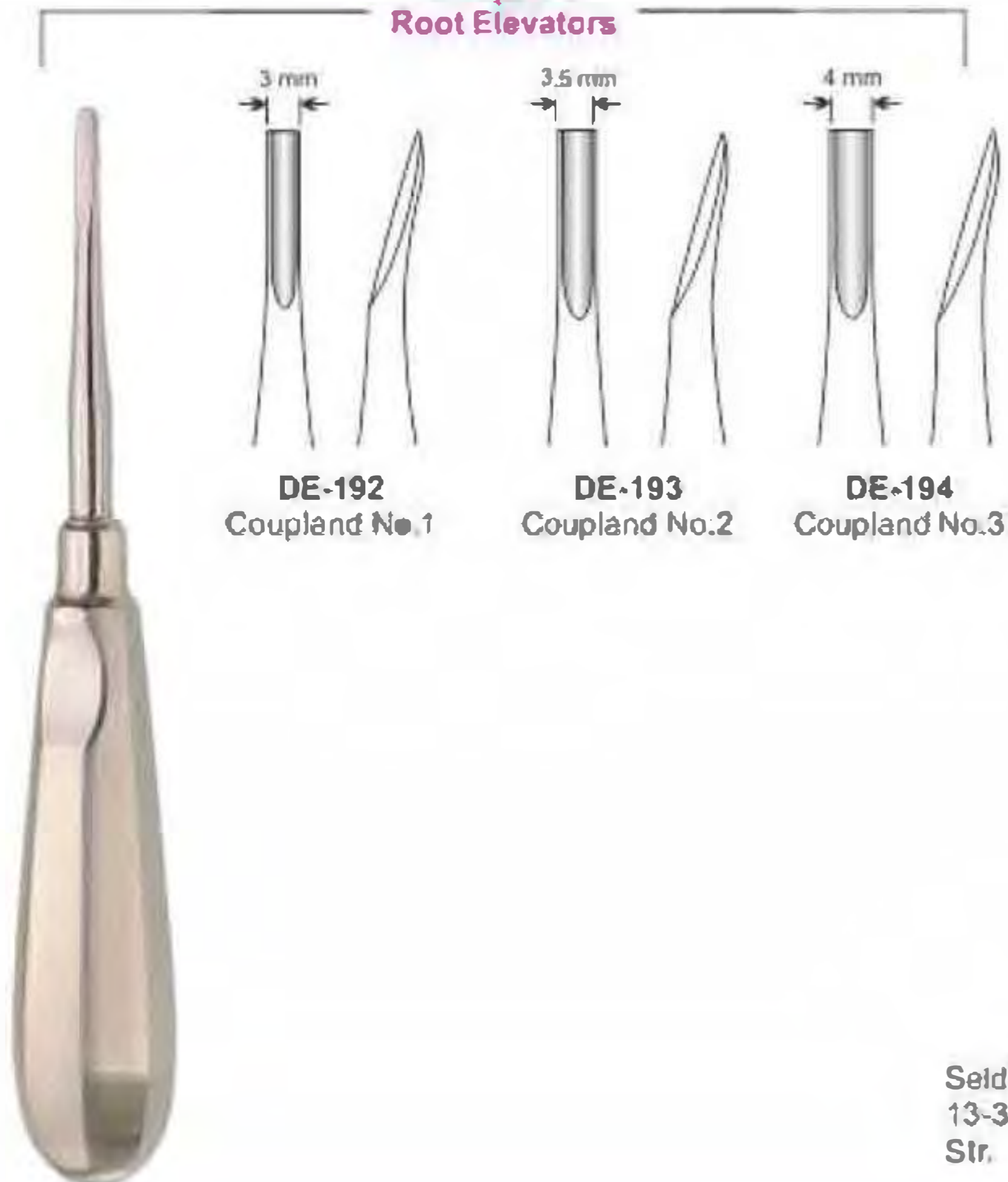

Seldin Root Elevators

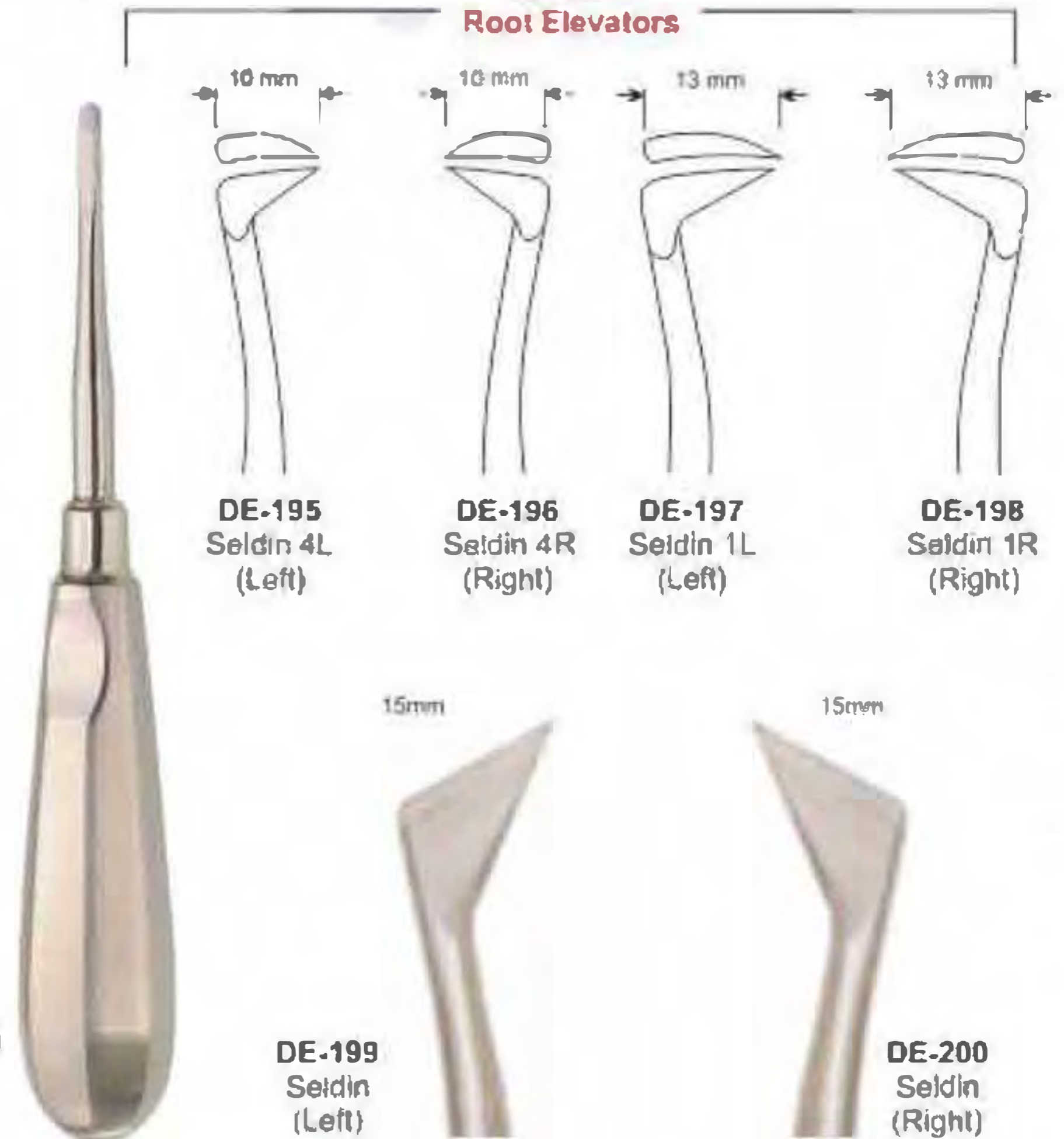

- Элеватор корневой экстракционный
- Elevateurs à racines
- Wurzelheber

- Elevator corneviai ekstraktsionniy
- Elevadores para raíces
- المصاعد الجذر



Apical Root Elevators

Apical Root Elevators

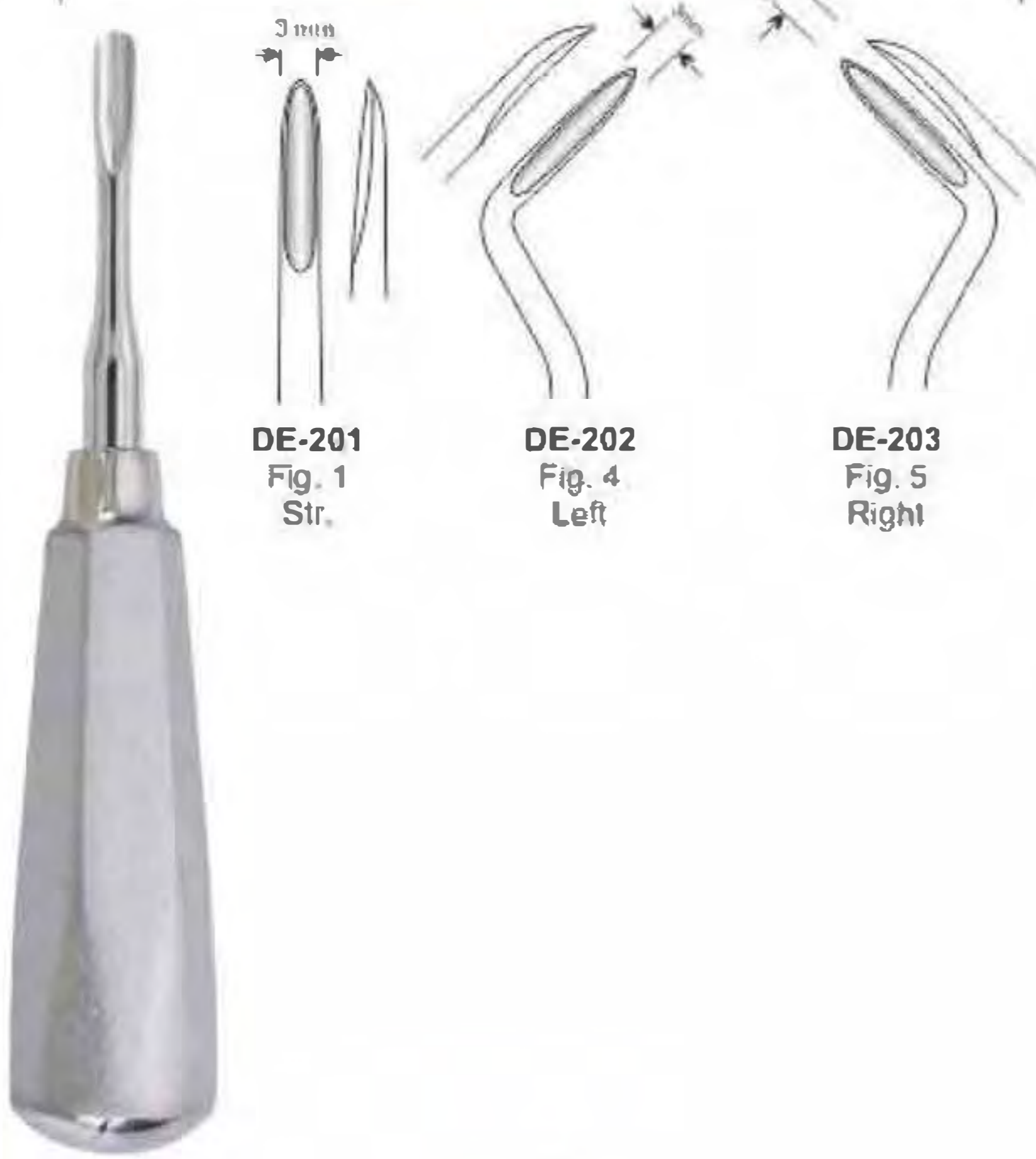

DE-201
Fig. 1
Str.

DE-202
Fig. 4
Left

DE-203
Fig. 5
Right

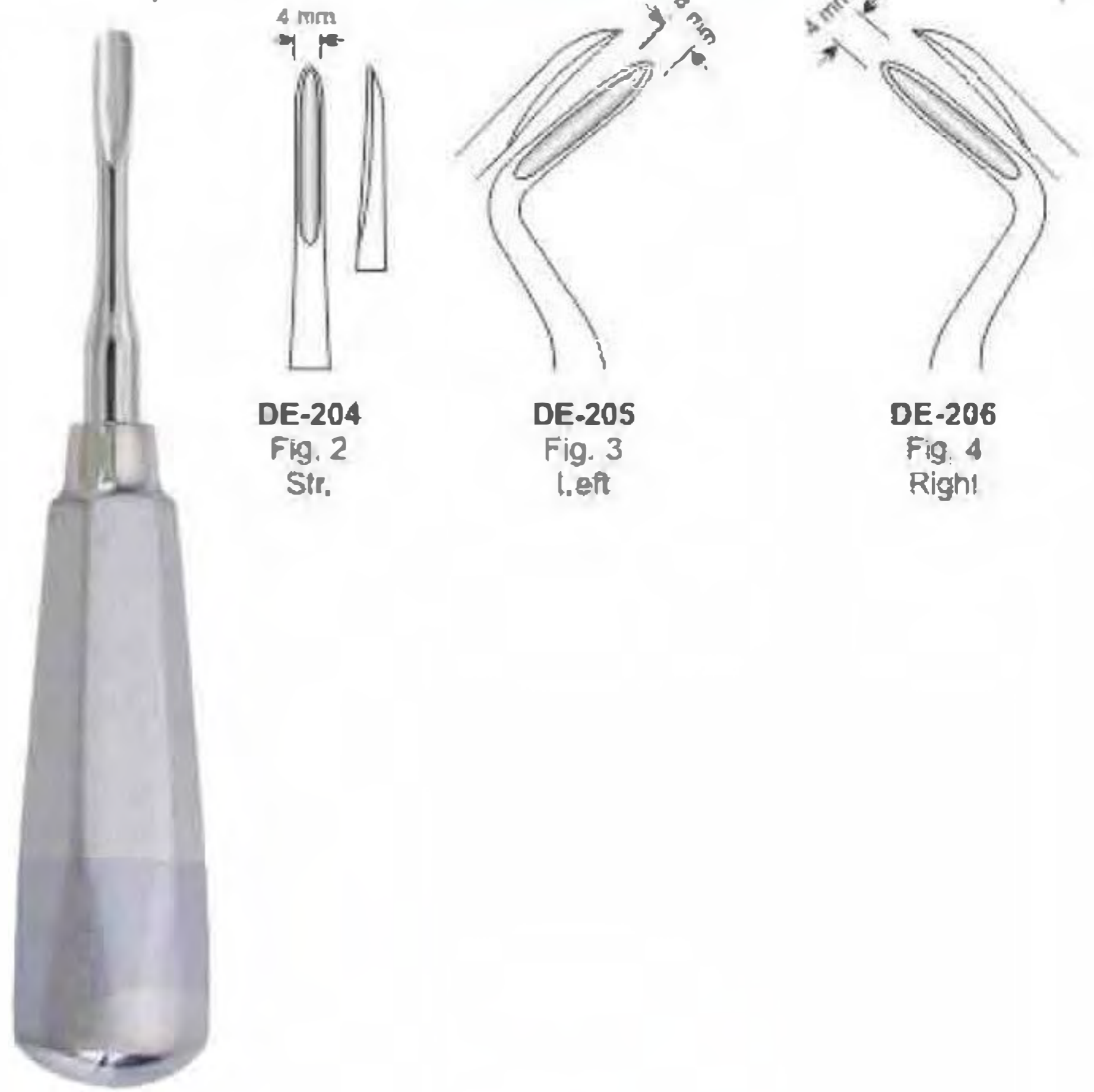

DE-204
Fig. 2
Str.

DE-205
Fig. 3
Left

DE-206
Fig. 4
Right

Coupland Root Elevators

Seldin Root Elevators

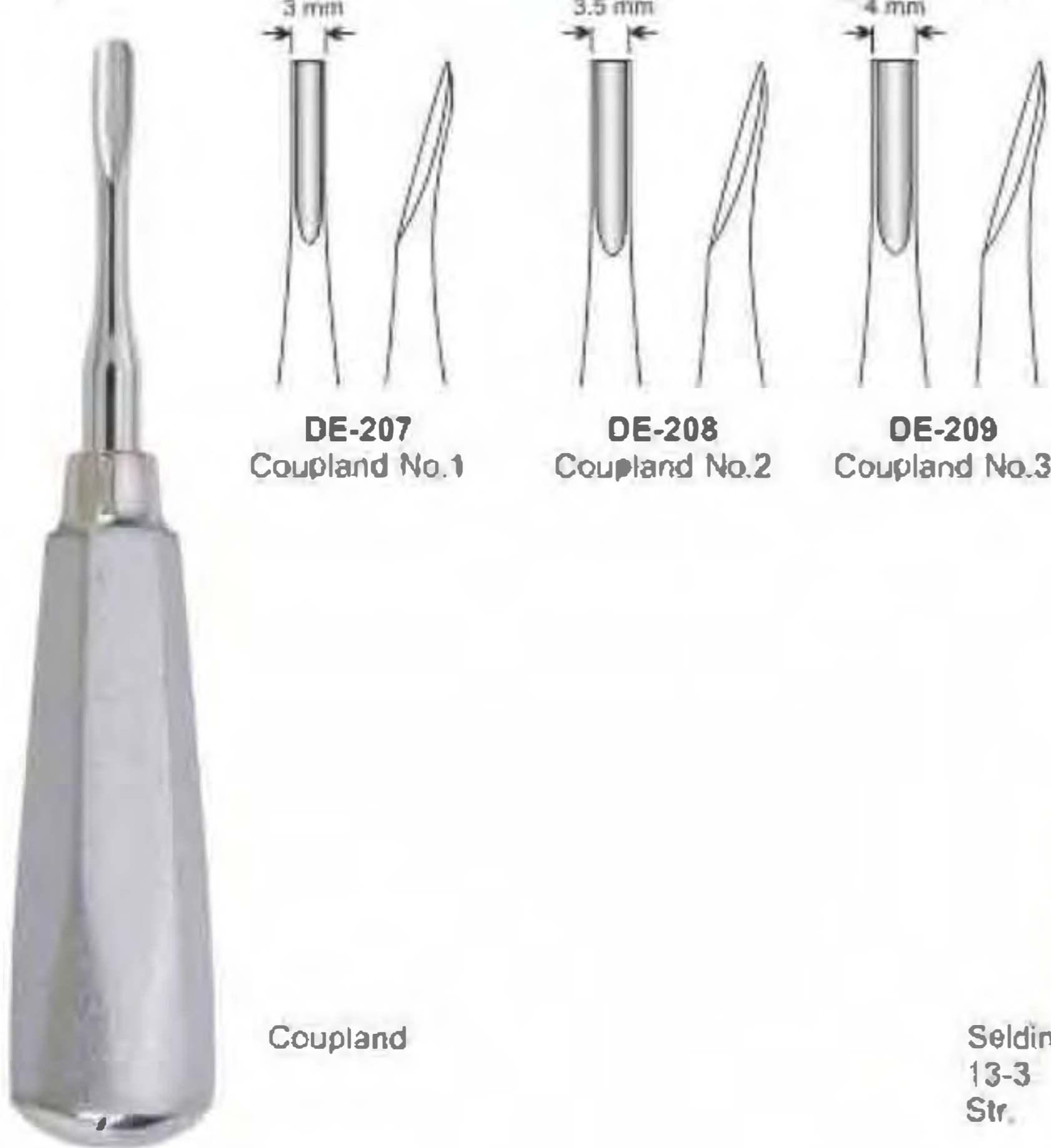

DE-207
Coupland No.1

DE-208
Coupland No.2

DE-209
Coupland No.3

Coupland



DE-210
Seldin 4L
(Left)

DE-211
Seldin 4R
(Right)

DE-212
Seldin 1L
(Left)

DE-213
Seldin 1R
(Right)

Seldin
13-3
Str.

DE-2
Seld
(Left)

DE-215
Seldin
(Right)

ROOT ELEVATOR

- Элеватор корневой экстракционный
 - Elevateurs à racines
 - Wurzelheber
- Elevator корневой экстракционный
 - Elevadores para raíces
 - المصاعد الجذر

Apical Root Elevators

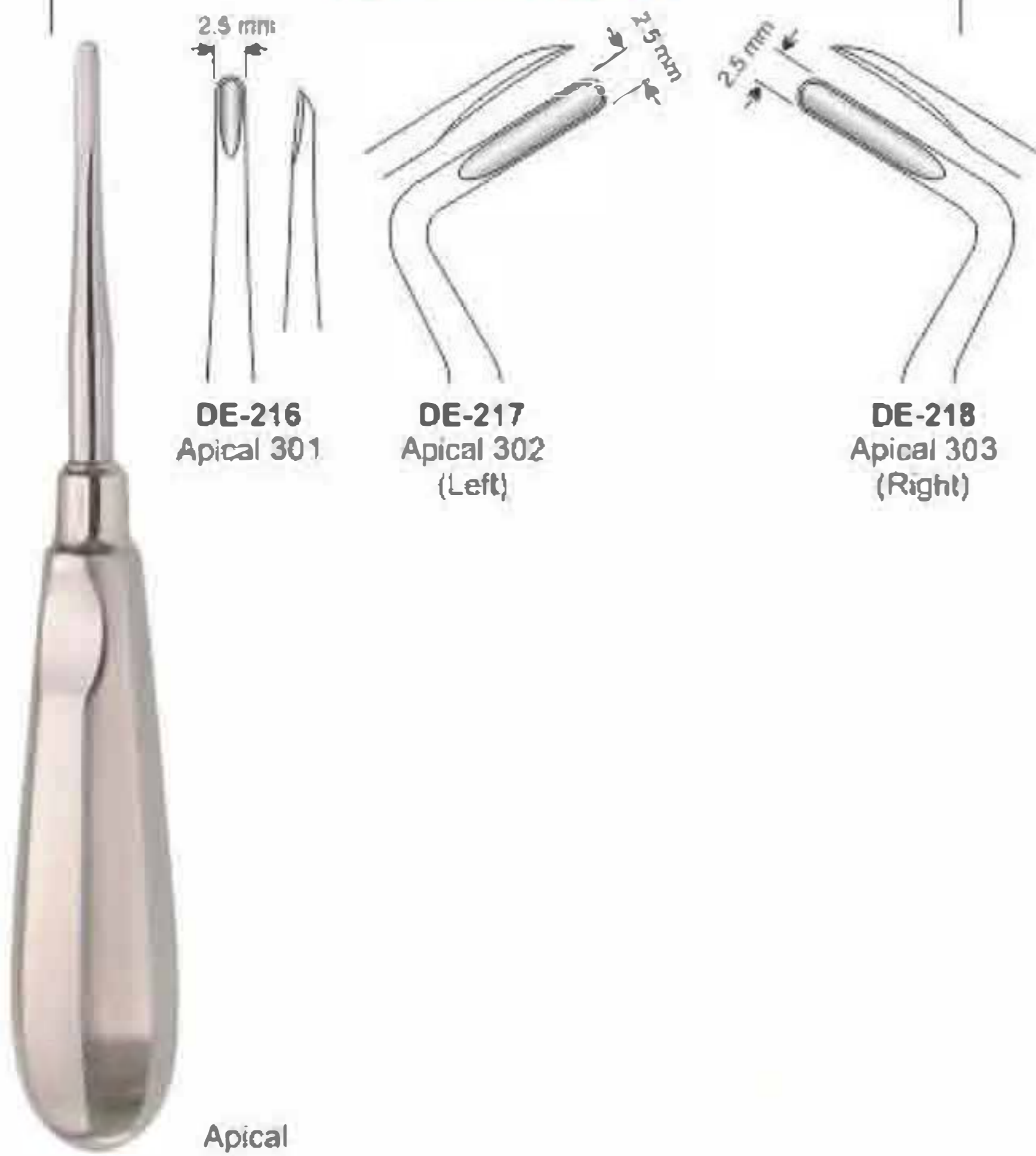

Apical Root Elevators

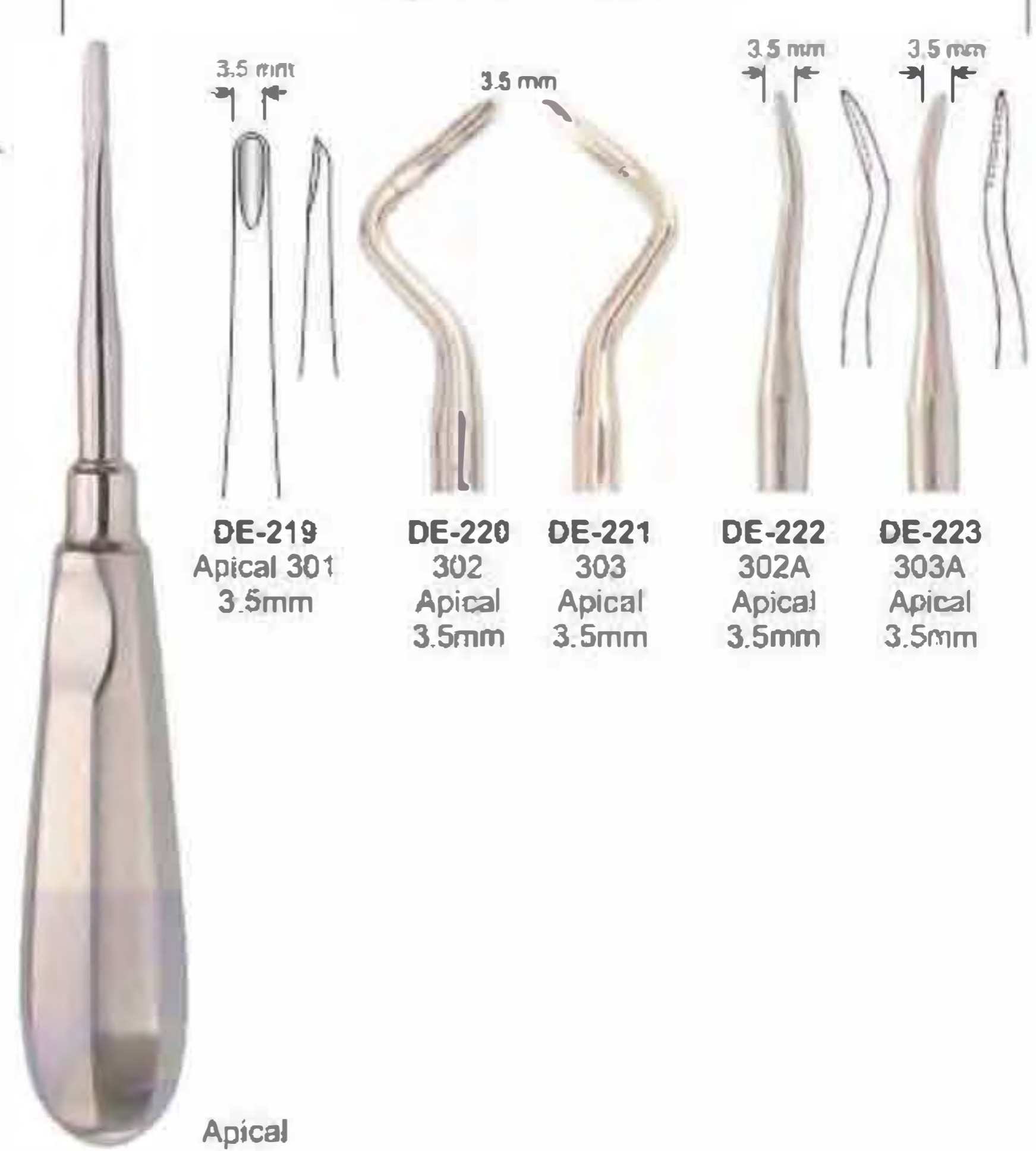

Apical Root Elevators

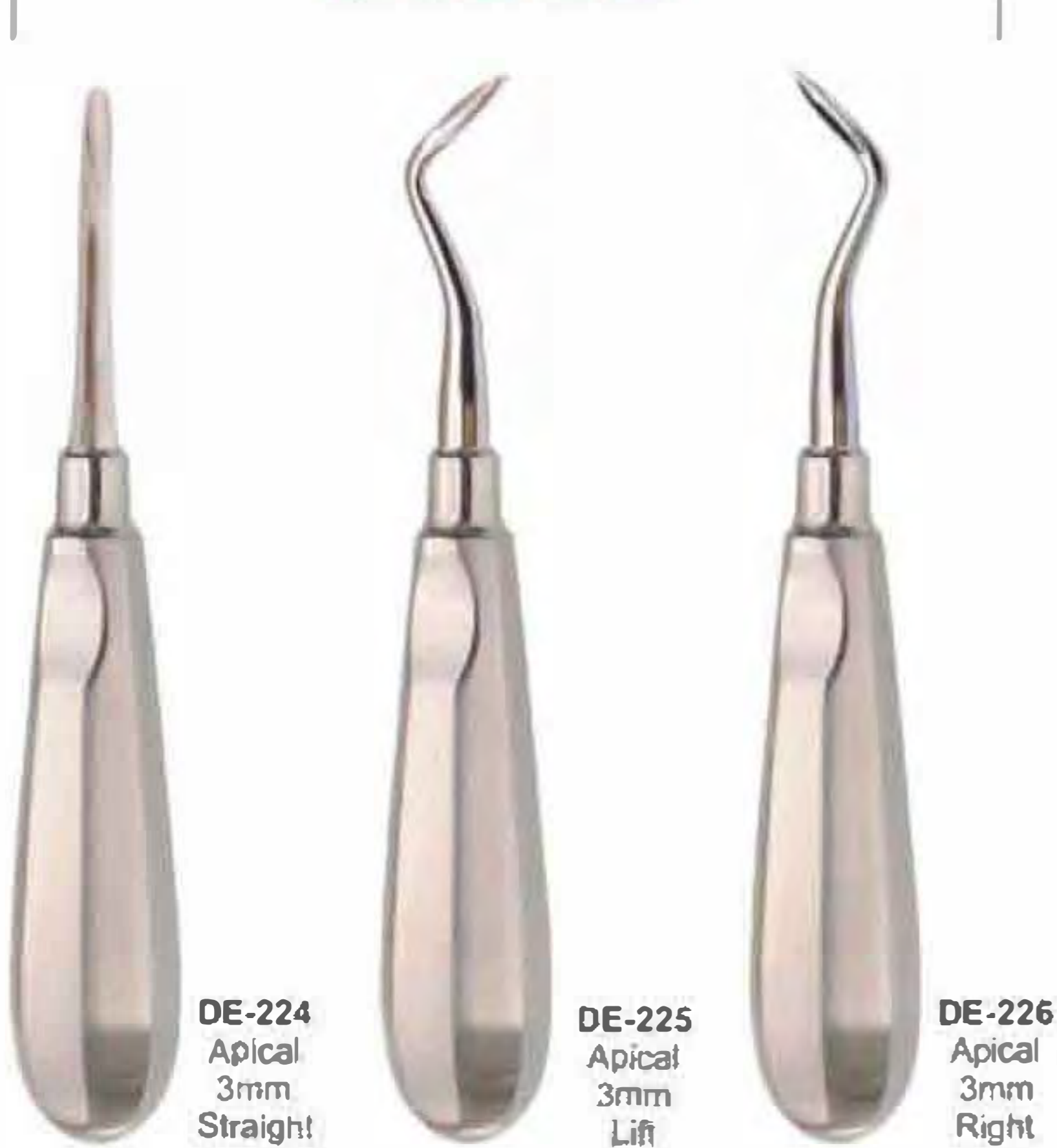

Laxator Root Elevators

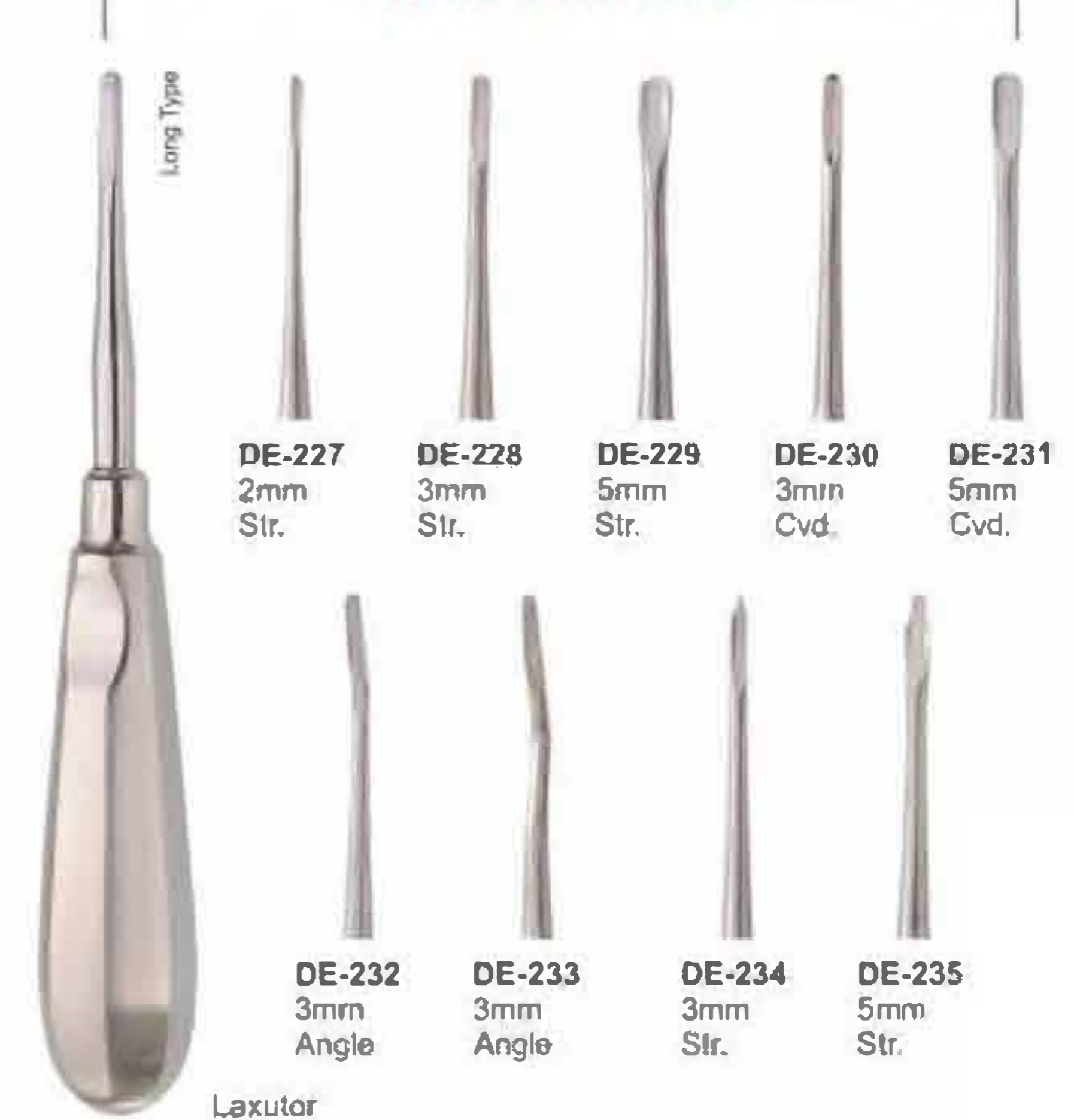

- Элеватор корневой экстракционный
- Elevateurs à racines
- Wurzelheber

- Elevador corneviai extraçcionii
- Elevadores para raices
- المهاد الجذر

Lindo Levian Root Elevators

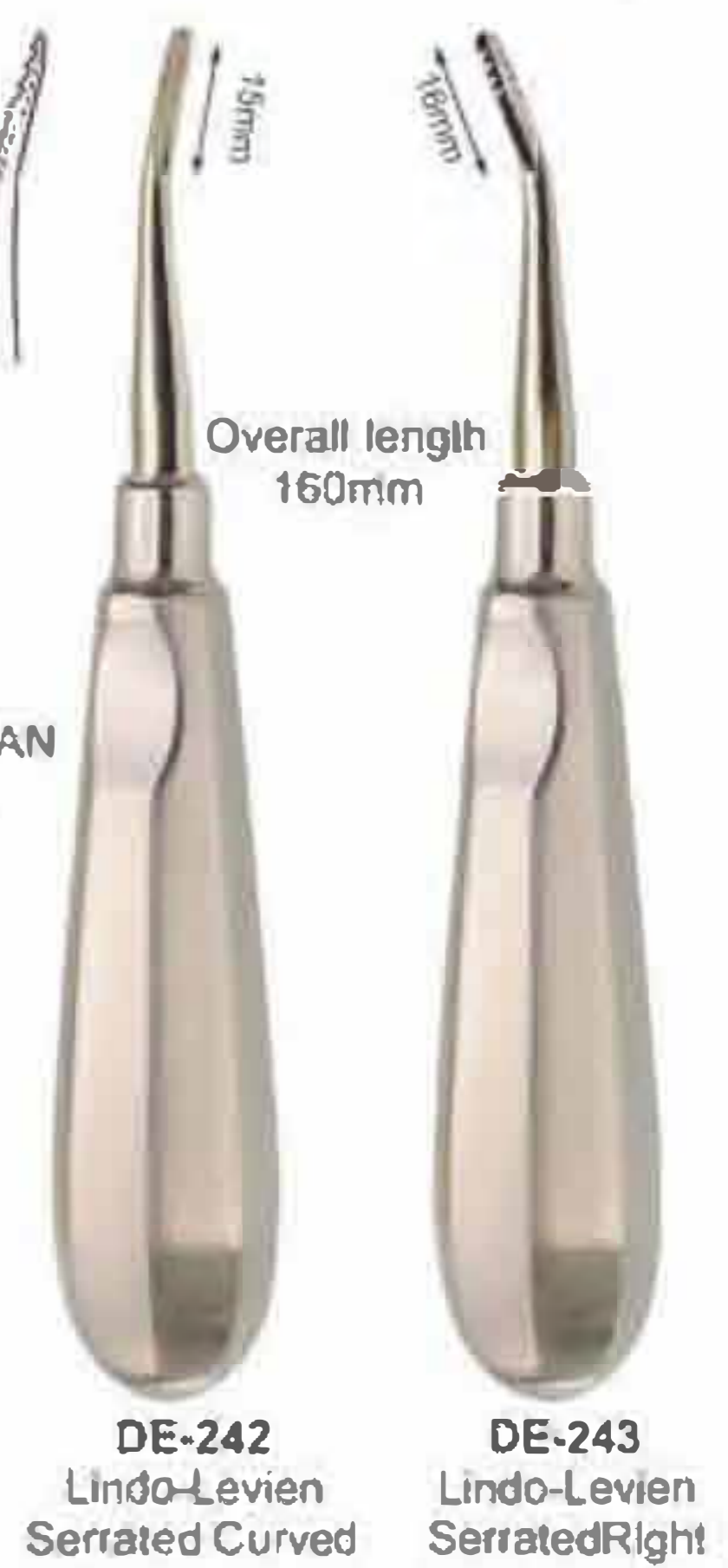

Flohr Root Elevators



Heidbrink Root Elevators

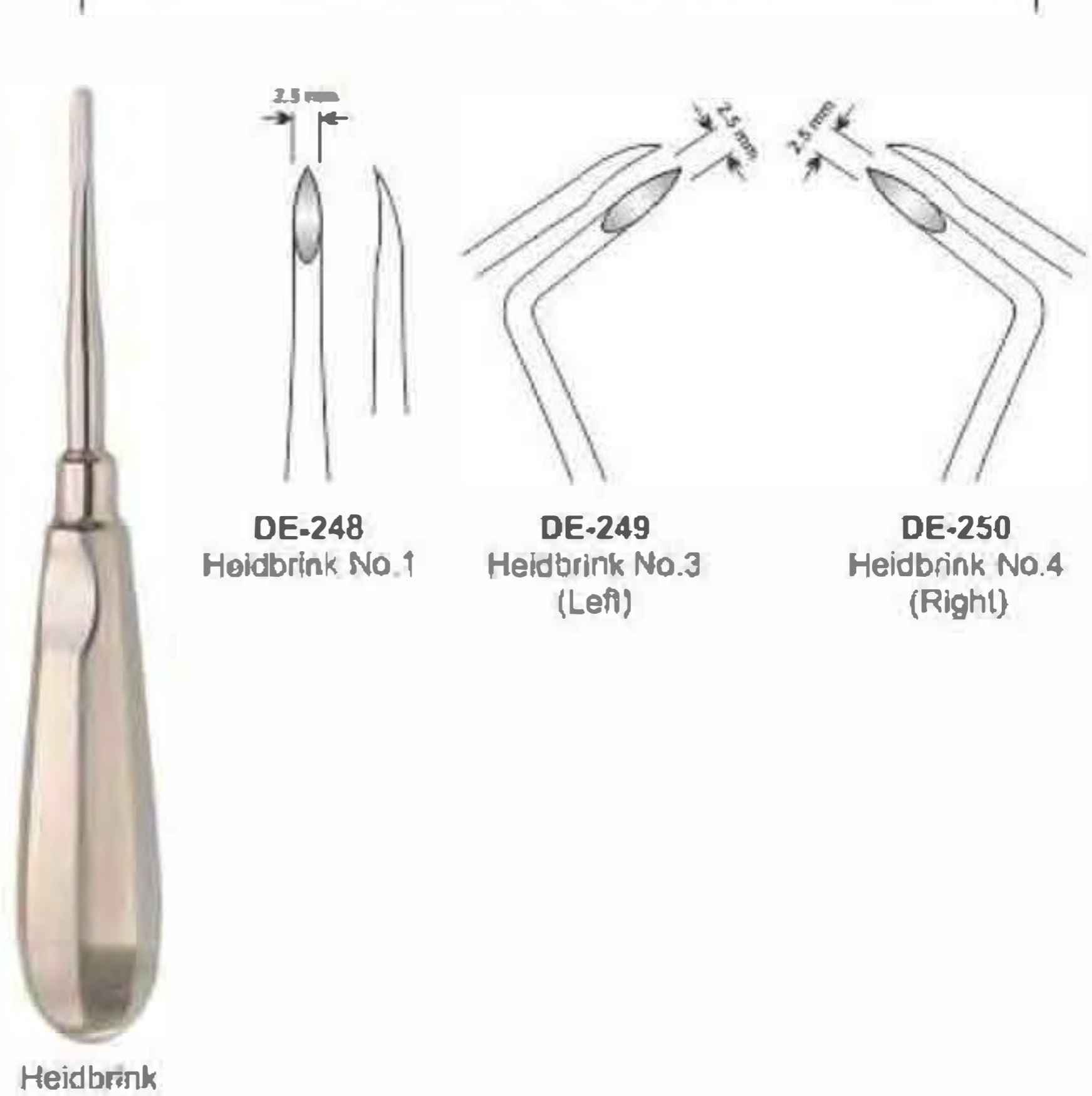

ROOT ELEVATOR

- Элеватор корневой экстракционный
- Elevateurs à racines
- Wurzelheber
- Elevator corneviu ekstraktsionnyy
- Elevadores para raíces
- المصاط الجذر

Friedmann Roots Elevator



DE-251 Friedmann 4F Str.
DE-252 Friedmann 5F Left
DE-253 Friedmann 6F Right

Heidbrink Roots Elevator



DE-254 Heidbrink Straight
DE-255 Heidbrink Left
DE-256 Heidbrink Right

Wisdom Roots Elevator



DE-257 Wisdom for 18 and 38
DE-258 Wisdom for 28 and 48

Bayonet Roots Elevator Set



DE-259 Left
DE-260 Right
DE-261 bayonet
DE-262 Curved
DE-263 Straight

Luxator Roots Elevator



DE-264 Luxator Straight
DE-265 Luxator Curved



- Элеватор корневой экстракционный
- Elévateurs à racines
- Wurzelheber
- Elevador cornevoii ekstraktsionnyi
- Elevadores para raíces
- المصاعد الجذر

Roots Elevator

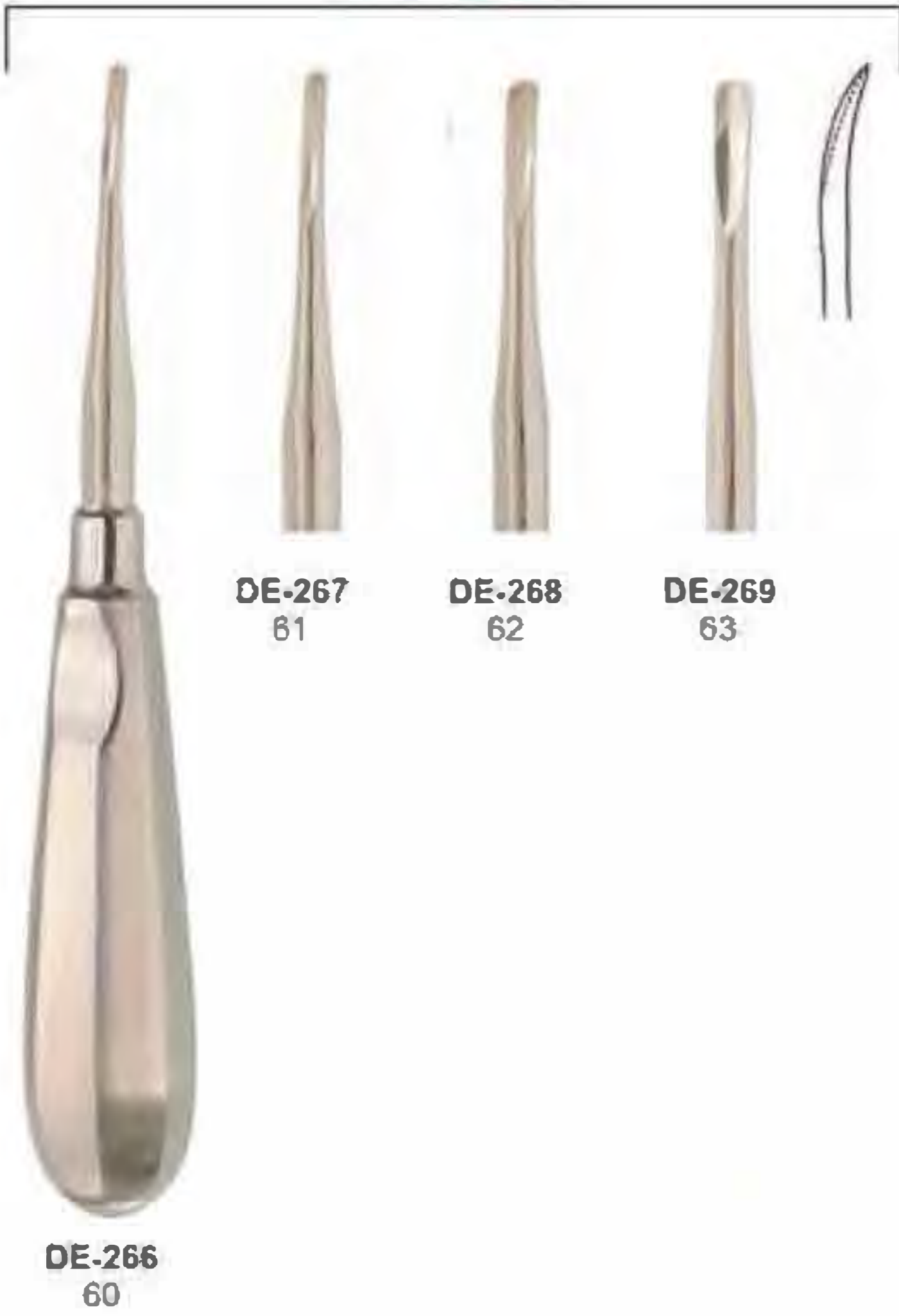

Luxier Roots Elevator



Luxier Roots Elevator

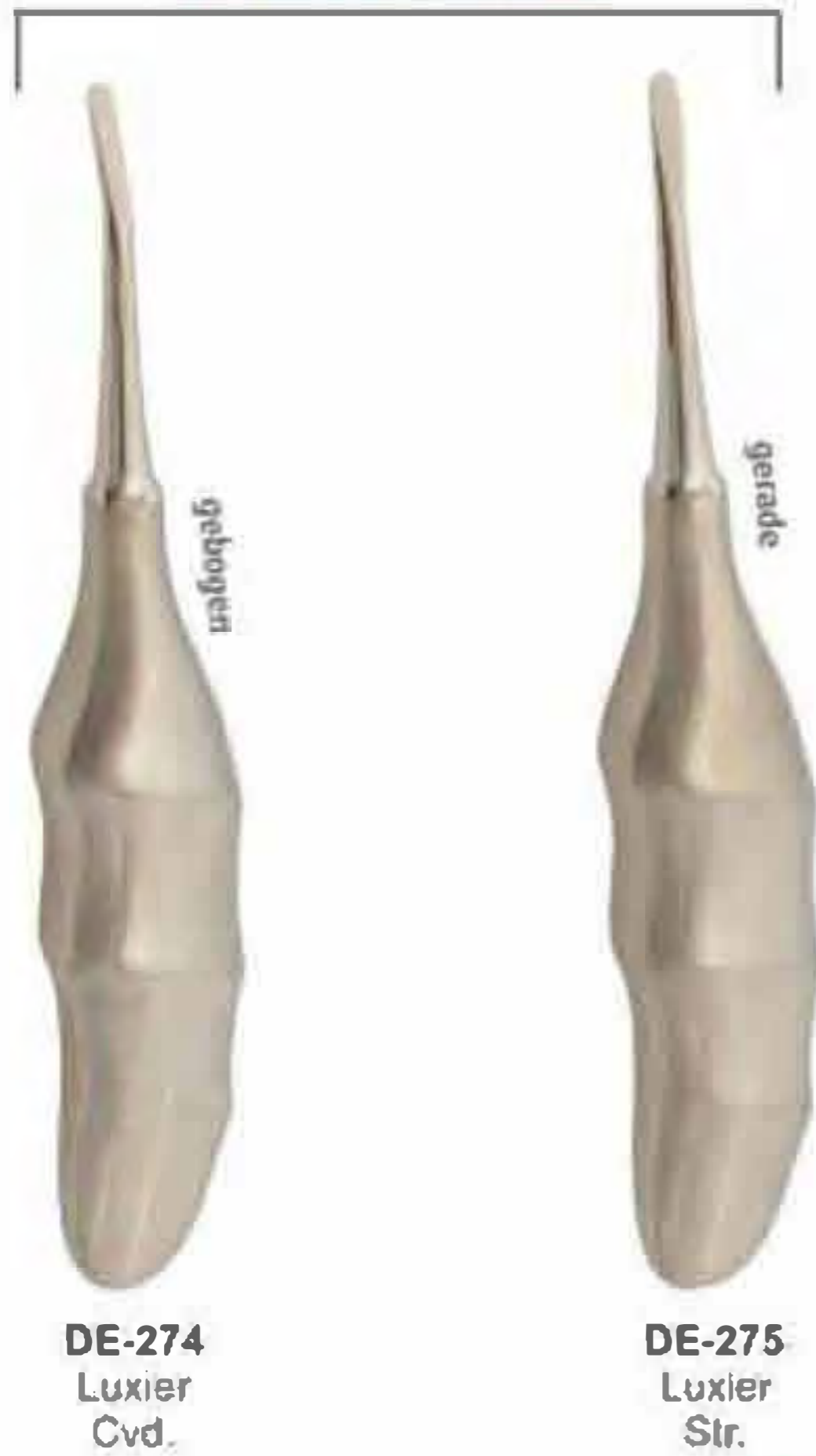

Claw-Lift Roots Elevator



ROOT ELEVATOR

- Элеватор корневой экстракционный
- Élévateurs à racines
- Wurzelheber
- Elevator coronevii ekstraktsionnyy
- Elevadores para raíces
- المصاعد الجذر

Hylin Roots Elevator



Cryer Roots Elevator



Kopp Roots Elevator

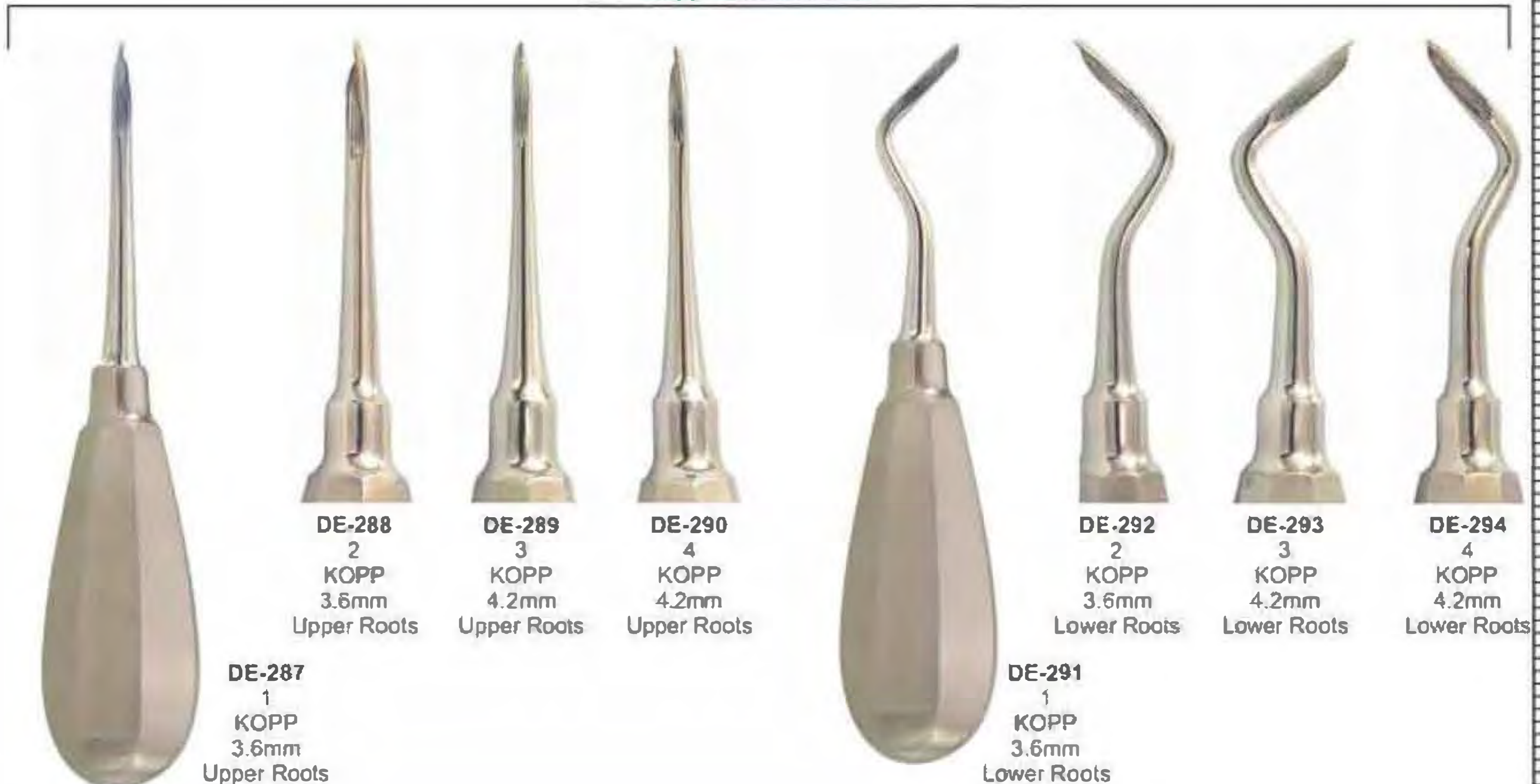

INCHES
0 1 2 3 4 5 6 7 8 9

- Элеватор корневой экстракционный
- Elevateurs à racines
- Wurzelheber

- Elevator cornevier ekstrakçionnyy
- Elevadores para raíces
- المصاعد الجذر

Kopp Roots Elevator



DE-295
Kopp
Right

DE-296
Kopp
Left

Heber Roots Elevator



DE-297
Heber
Bayonet

DE-298
Heber
Bayonet

Bein Roots Elevator



DE-299
Bein,
3mm

DE-300
Bein,
4mm

Bein Roots Elevator

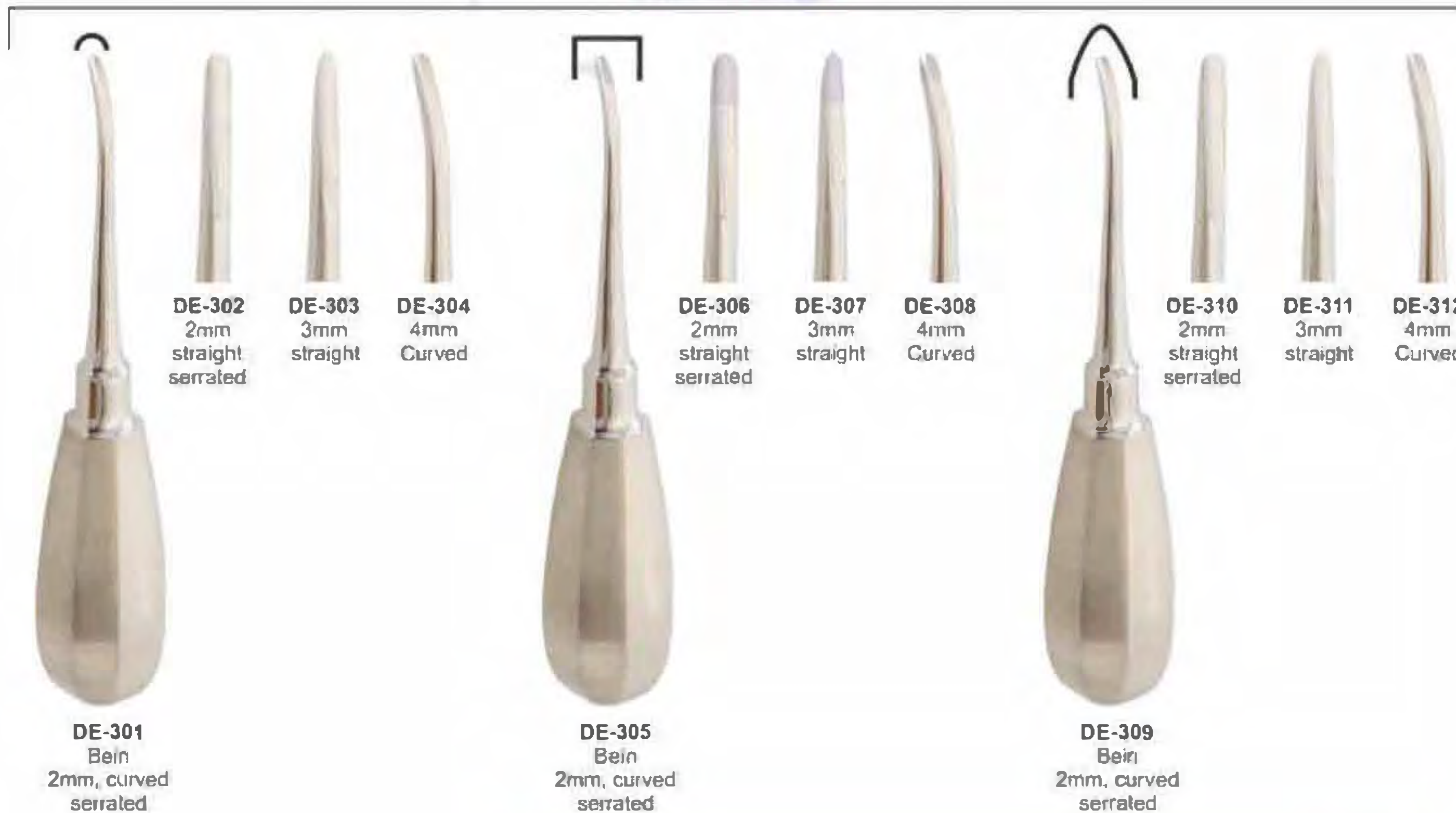

DE-302
2mm
straight
serrated

DE-303
3mm
straight

DE-304
4mm
Curved

DE-306
2mm
straight
serrated

DE-307
3mm
straight

DE-308
4mm
Curved

DE-310
2mm
straight
serrated

DE-311
3mm
straight

DE-312
4mm
Curved

DE-301
Bein
2mm, curved
serrated

DE-305
Bein
2mm, curved
serrated

DE-309
Bein
2mm, curved
serrated



ROOT ELEVATOR

- Элеватор корневой экстракционный
- Elevateurs à racines
- Wurzelheber
- Elevator corvívivvy ekstrakçívívvy
- Elevadores para raíces
- المصاعد الجذر

Seldin Roots Elevator



W. Barry Roots Elevator



Winter Roots Elevator



Pott Roots Elevator

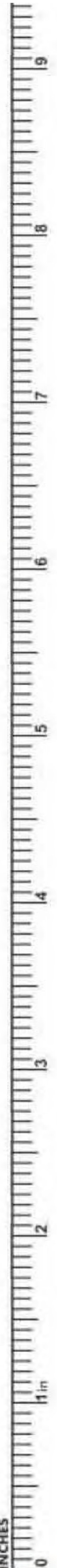

- Элеватор корневой экстракционный
- Élévateurs à racines
- Wurzelheber

- Elevador cornevoii ekstraktsionnyi
- Elevadores para raíces
- المصاعد الجذر

Heidbrink Roots Elevator



DE-338
Heidbrink
Straight

DE-339
Heidbrink
Left

DE-340
Heidbrink
Right

DE-341
Heidbrink
Straight

DE-342
Heidbrink
Left

DE-343
Heidbrink
Right

Syndesmotomes Roots Elevator



DE-344
Straight

DE-345
Left

DE-346
Right

Periotome Roots Elevator

Syndesmotomes



DE-347
Periotome
2.1mm
Straight

DE-348
Periotome
2.6mm
Straight

DE-349
Periotome
2.1mm
Angular

DE-350
Periotome
2mm
Curved

DE-351
Periotome
2.0mm

DE-352
Periotome
2.5mm

DE-353
Periotome
3.0mm

DE-354
Periotome
4.0mm



ROOT ELEVATOR

- Элеватор корневой экстракционный
- Elevateurs à racines
- Wurzelheber
- Elevator corneveiv ekstraktsionnyy
- Elevadores para raíces
- المصاعد الجذر



DE-355
1S
(Straight 1mm)



DE-356
2S
(Straight 2mm)



DE-357
3S
(Straight 3mm)



DE-358
5S
(Straight 5mm)



DE-359
3C
(Curved 3mm)



DE-360
5C
(Curved 5mm)



DE-361
3CA
(Curved Angle 3mm)



DE-362
3IC
(Inverted Curved 3mm)



DE-363
DE 3
(Dual Edge 3mm / 1.5mm)



DE-364
DE 5
(Dual Edge 5mm / 3mm)



INCHES

- Элеватор корневой экстракционный
- Elévateurs à racines
- Wurzelheber
- Elevadores para raíces
- المساعد الجذر

PDL ELEVATORS



DE-365
PDL Elevators
Set of 7 Pcs

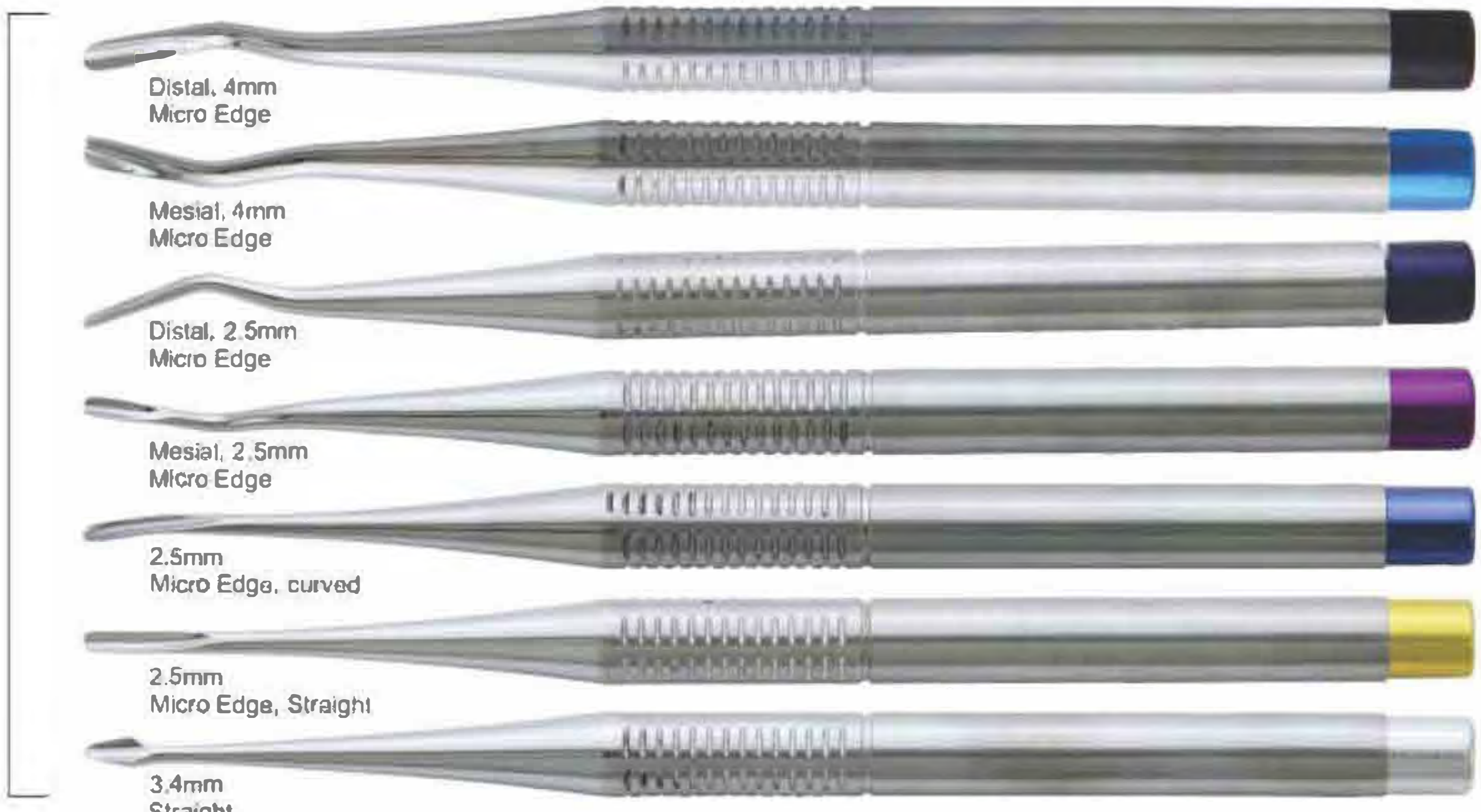

DE-366
PDL Elevators
Set of 7 Pcs

ROOT ELEVATOR

- Элеватор корневой экстракционный
- Elevateurs à racines
- Wurzelheber
- Elevator coronevii ekstraktsionnyy
- Elevadores para raíces
- المصاعد الجذر

PDL ELEVATORS

Delicate Arrow tip



4,0mm straight
4,0mm curved

Luxivators straight
atraumatic luxation of the tooth



2,5mm straight
3,5mm straight
4,5mm straight

Luxivators curved
atraumatic luxation of the tooth



2,5mm curved
3,5mm curved
4,5mm curved



DE-367
PDL Elevators
Set of 8 Pcs



Our Scalers

Compare our scalers and curettes with the best in the industry and you will immediately recognize we are equal in every way but one... price. Note the deep precision knurling for better tactile feel. The same high-grade stainless steel tips, the same light weight (under 18 grams) for less hand fatigue, the same professional craftsmanship, and surpassing the highest industry standards. Of course, any manufacturer can make these claims, but we guarantee and certify ours.

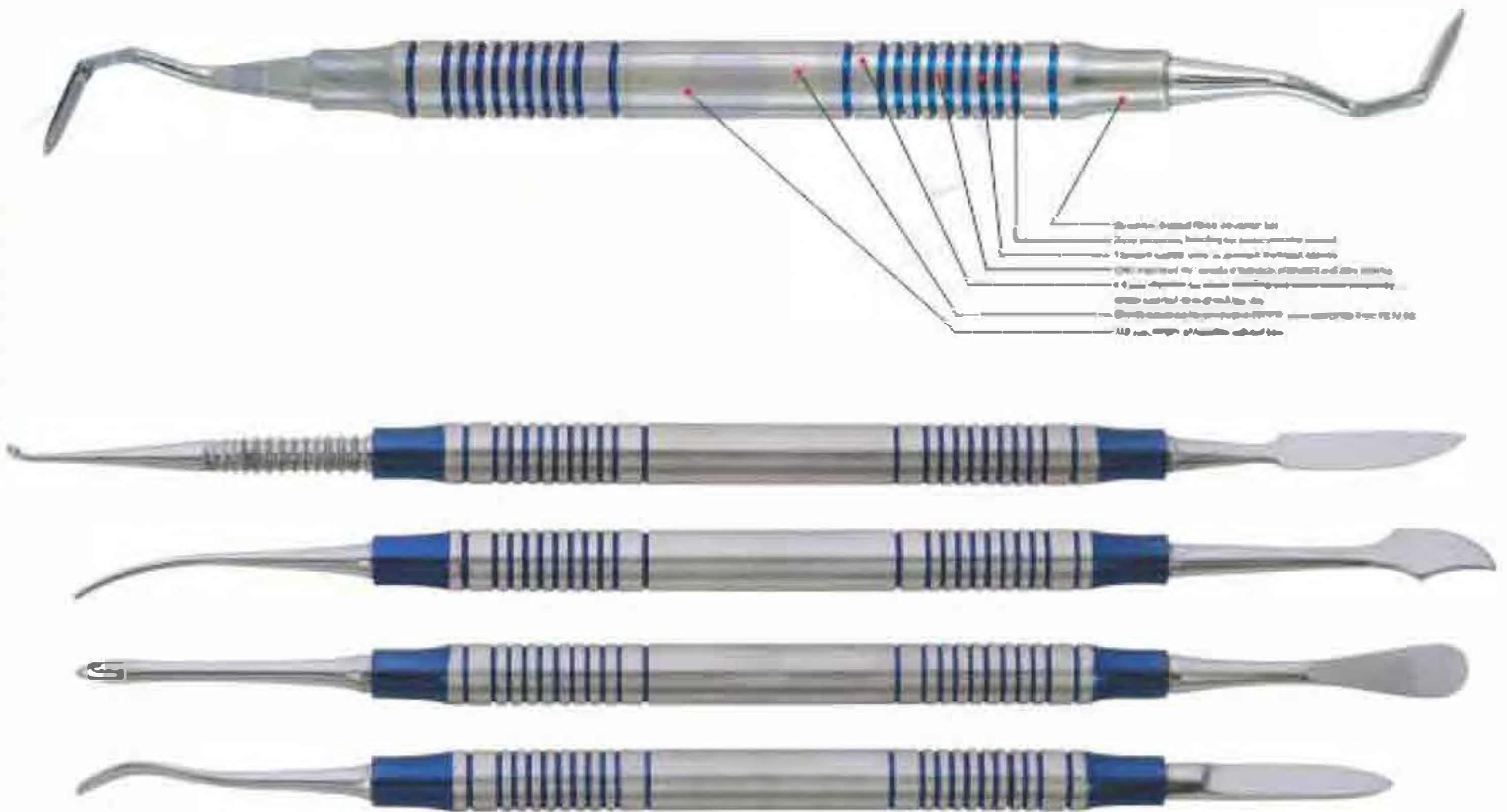
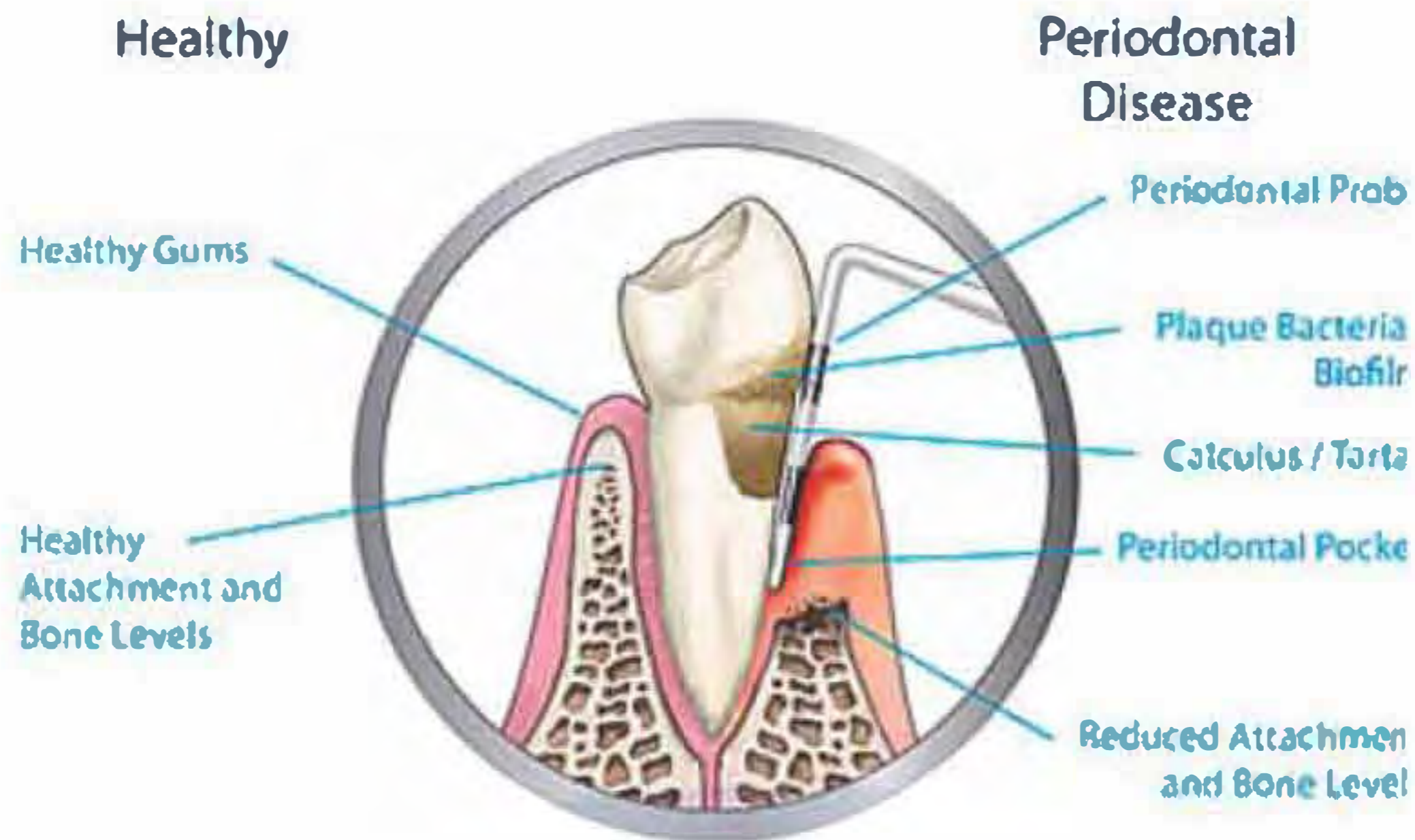

- High-polish mirror finish tips.
- Manufactured within the guidelines of the FDA quality assurance system for good manufacturing practices.
- Highest grade German stainless steel, razor sharp, durable tips. Rockwell hardened to 60 RHC.
- 27 of the most popular designs from Graceys to McCalls to Columbias, and many European patterns.
- All instruments are guaranteed against defects in material and workmanship.

- All instruments bear the CE mark, emblematic of the European community's highest standards.
- Customer satisfaction guarantee, too!
- Less than 20 grams ... Lightweight for less hand fatigue.
- Manufactured to the most exacting standards so the 50th instrument you buy is exactly like your first.
- You decide ... Why pay more for the same high-quality instruments?

HANDLES FOR MOUTH MIRRORS

- Ручки для зеркал
- Manches pour miroirs à bouche
- Mundspiegelgriffe
- Ручки для дзеркал
- Mangos para espejos de boca
- مقبض لمرآة الفم



Magnifying

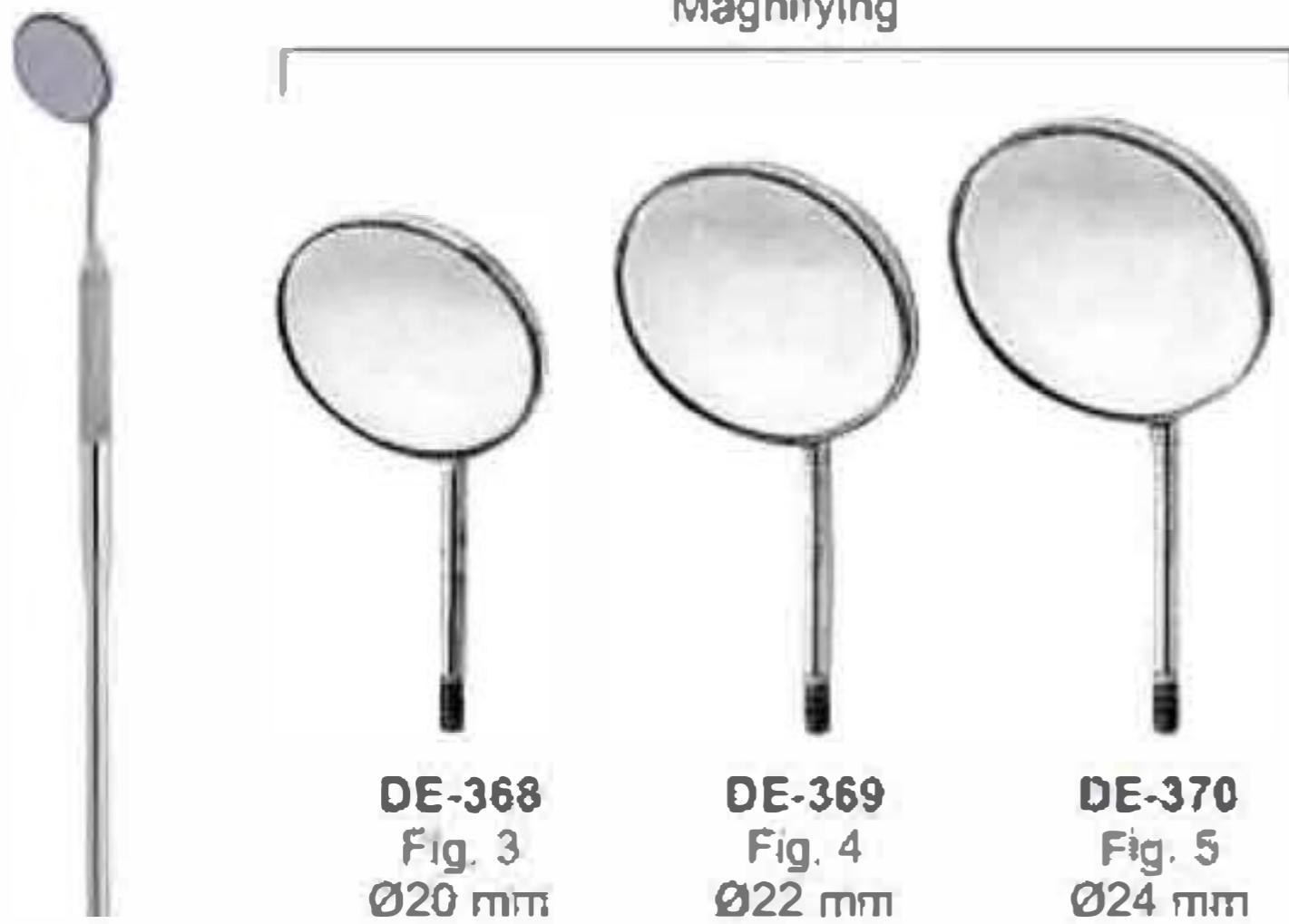

DE-368
Fig. 3
Ø20 mm

DE-369
Fig. 4
Ø22 mm

DE-370
Fig. 5
Ø24 mm



Plain

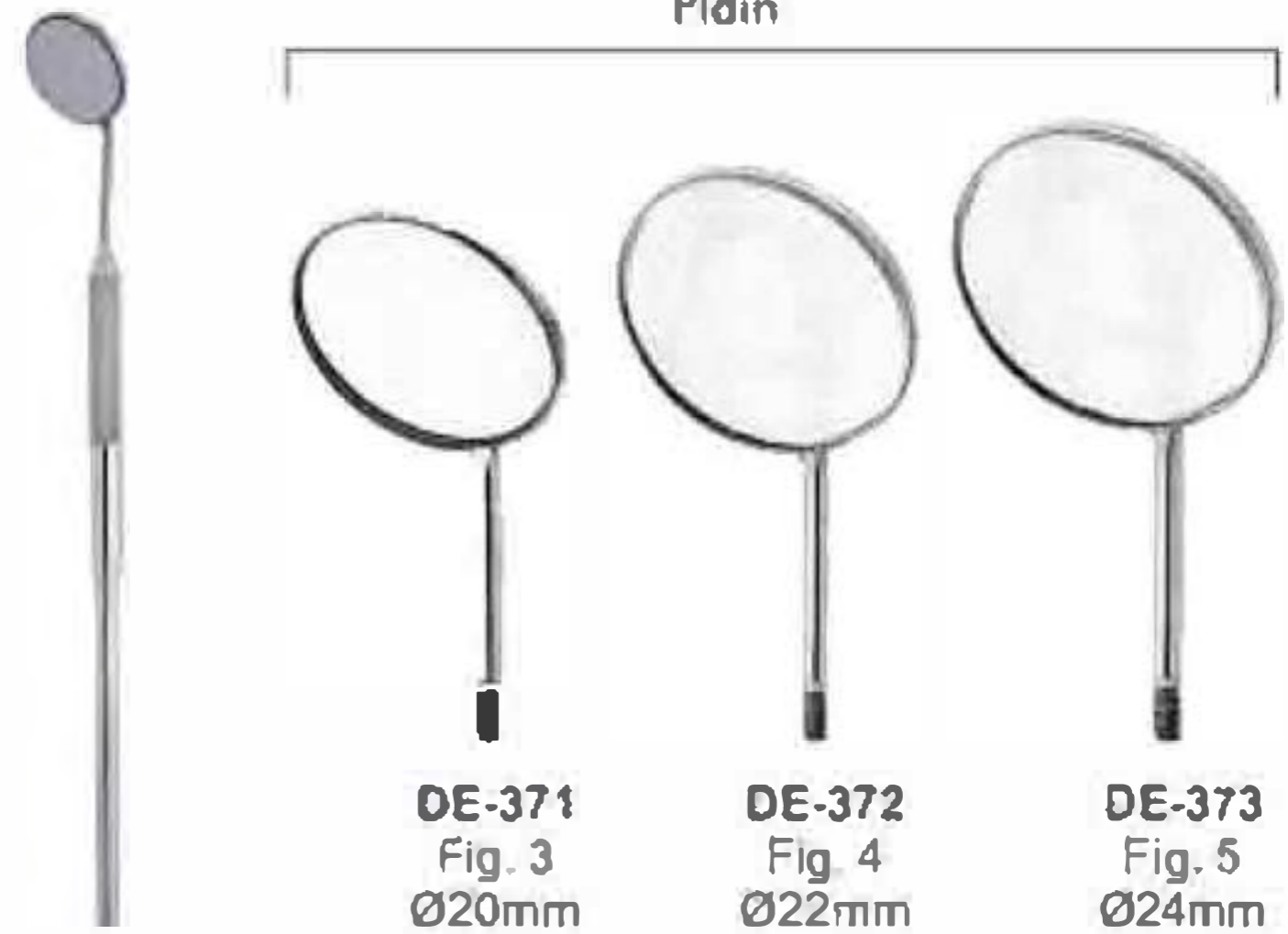

DE-371
Fig. 3
Ø20mm

DE-372
Fig. 4
Ø22mm

DE-373
Fig. 5
Ø24mm



Rhodium

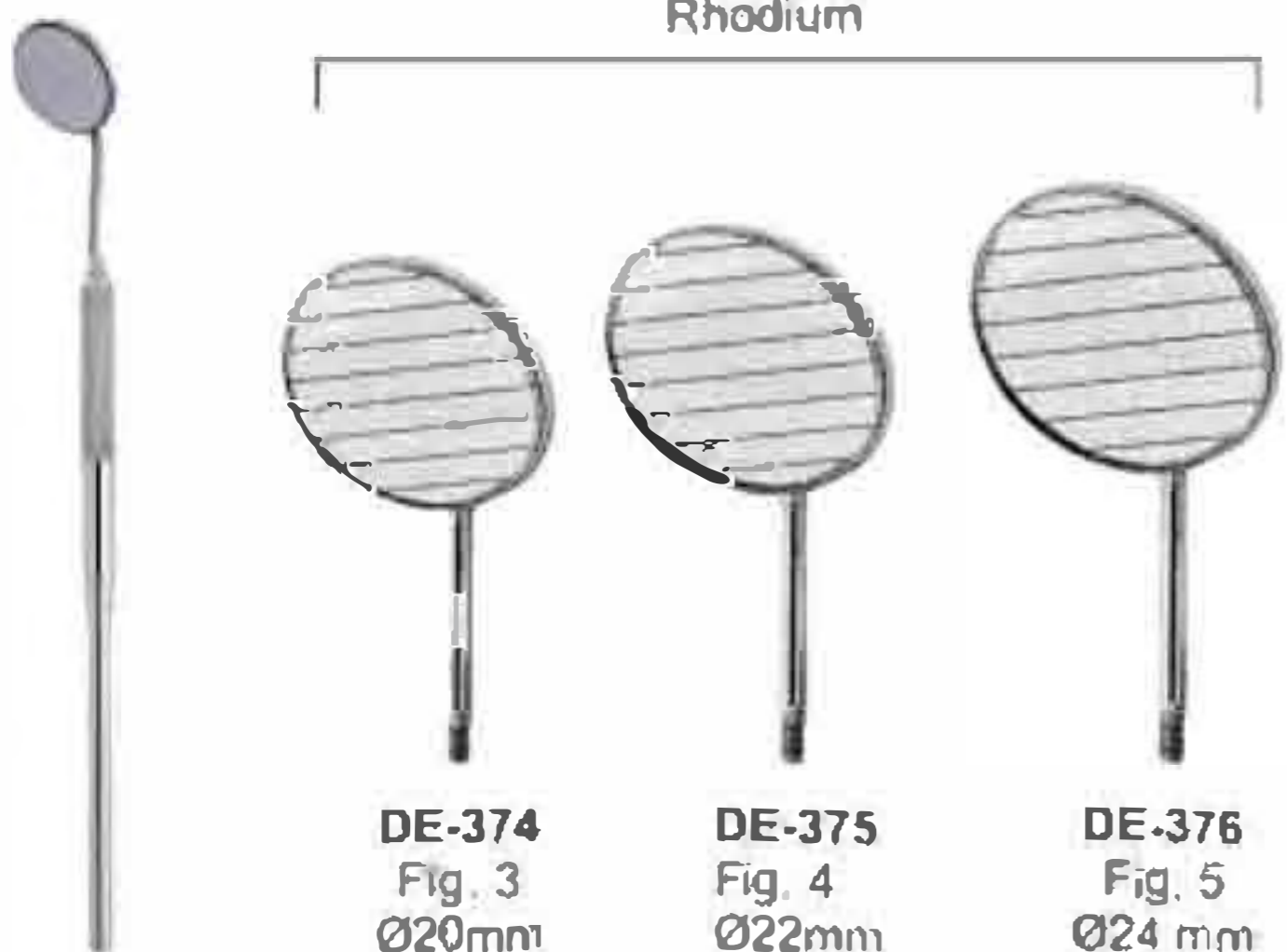

DE-374
Fig. 3
Ø20mm

DE-375
Fig. 4
Ø22mm

DE-376
Fig. 5
Ø24 mm



DE-377 Hollow Mirror Handle Stem Extra Light (7.5mm) Length 5"

DE-378 Mirror Handle Stem Octagonal (6mm) Length 5"

DE-379 Mirror Handle Stem Round (6mm) Length 5"

DE-380 Mirror Handle Stem with Rule 35mm (6mm) Length 5"



- Пинцеты
- Pinçettes - Brucelles
- Zahnpinzetten

- Пинцети
- Pinzas para algodón
- پینس



DE-381
Surgical
11.5cm



DE-382
London College
15cm



DE-383
Semken Taylor
Str.



DE-384
Semken Taylor
Cvd.



DE-385
Meriam
16cm



DE-386
Dressing
14cm



DE-387
Semken Taylor
1x2 Straight



DE-388
Semken Taylor
1x2 Curved



DE-389
Gilles
15cm 1x2



DE-390
14cm 1x2



DE-391
Perry
13cm



DE-392
Atraumatic
15cm Cvd



DE-393
Atraumatic
15cm Str.



DE-394
College with Lock
15cm Cvd.



DE-395
Gerald
17.5cm



DE-396
with lock
15cm



DE-397
Atraumatic
17.5cm



CENTIMETERS

TWEEZERS

- Пинцеты
- Präzelles - Brucelles
- Zahnpinzetten

- Пинцети
- Pinzas para algodón
- ملاقط



DE-398
Adson-TC
12cm



DE-399
Adson-TC
12cm 1x2



DE-400
Adson-TC
15cm 1x2



DE-401
Adson
12cm



DE-402
Adson
12cm 1x2



DE-403
Adson
15cm 1x2



DE-404
Adson Brown
12cm



DE-405
Crane Kaplan
15cm



DE-406
Crane Kaplan
15cm



DE-407
Crane Kaplan
15cm



DE-408
Hemingway
15cm



DE-409
Miller
15cm Str.



DE-410
Miller
15cm Cvd.



DE-411
Dressing
Tweezer
14.5cm



DE-412
College
Curved
Tip 15cm



DE-413
Maryam
Tweezers
15cm



DE-414
College
Tweezer
15cm



DE-415
Perry
Tweezer
12.5cm



DE-416
Self-locking
Tweezer
15cm



- Зонды
- Sondes
- Zahnsonden
- زوندي
- Sondas
- المستكشفين

Single Ended Probe Solid Handle 4.5mm Length 150mm



Fig. 2
Normal Handle

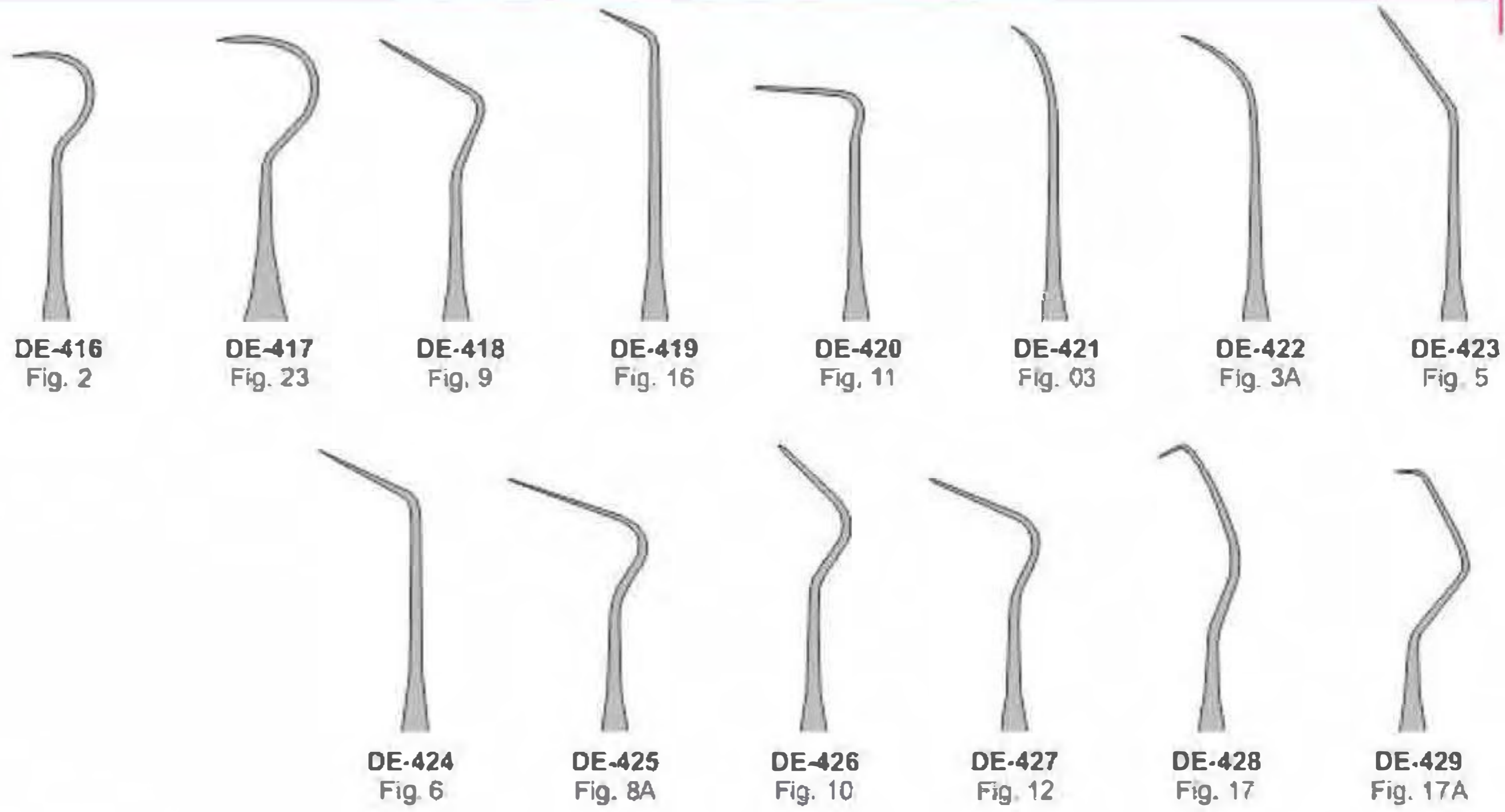

- | | | | | | | | |
|------------------|-------------------|------------------|-------------------|-------------------|-------------------|-------------------|--------------------|
| DE-416
Fig. 2 | DE-417
Fig. 23 | DE-418
Fig. 9 | DE-419
Fig. 16 | DE-420
Fig. 11 | DE-421
Fig. 03 | DE-422
Fig. 3A | DE-423
Fig. 5 |
| | | DE-424
Fig. 6 | DE-425
Fig. 8A | DE-426
Fig. 10 | DE-427
Fig. 12 | DE-428
Fig. 17 | DE-429
Fig. 17A |

Single Ended Probe Hollow Handle 8.5mm Length 150mm



Fig. 2
Anatomic Handle

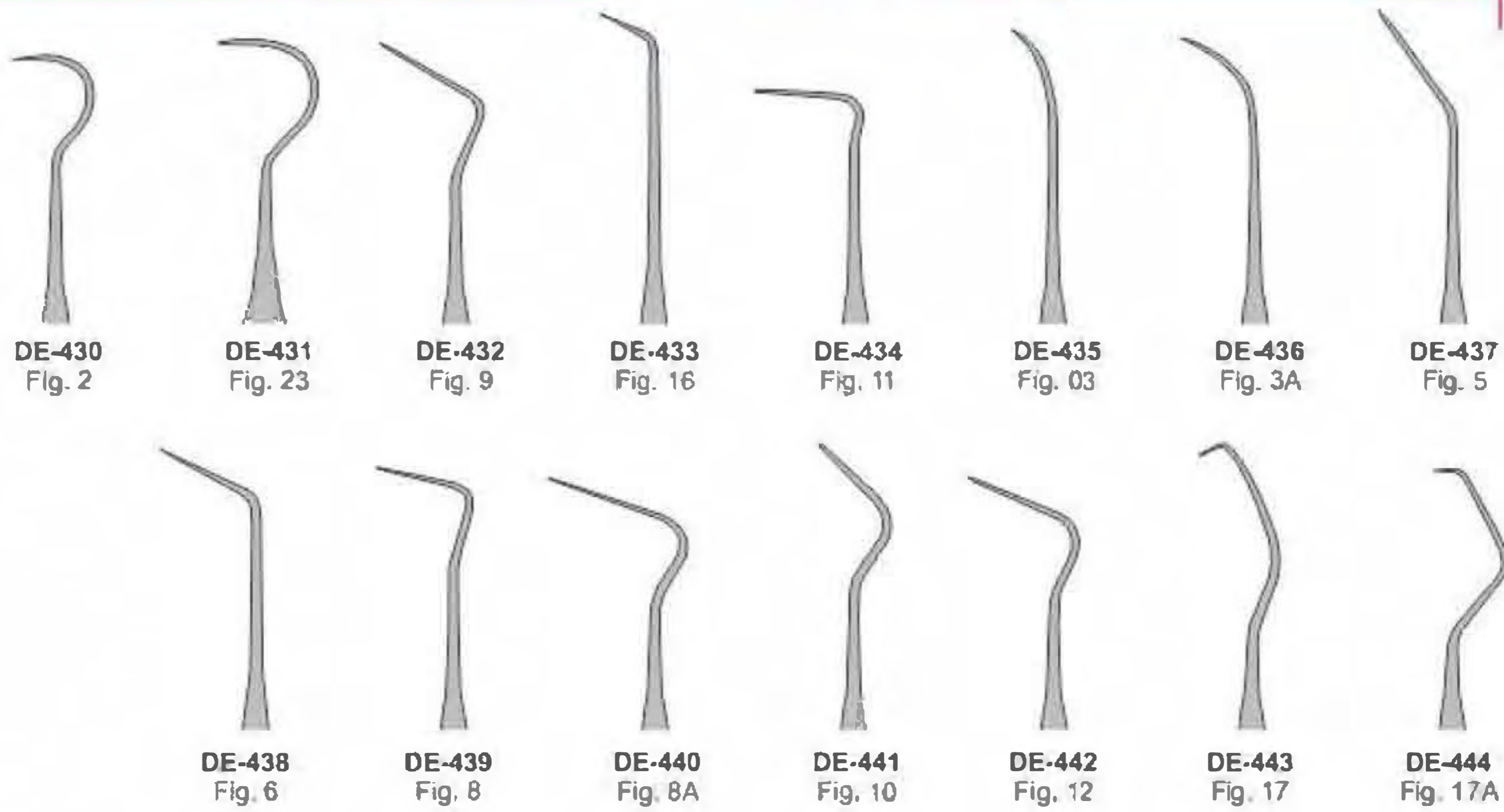

- | | | | | | | | | |
|------------------|-------------------|------------------|-------------------|-------------------|-------------------|-------------------|-------------------|--------------------|
| DE-430
Fig. 2 | DE-431
Fig. 23 | DE-432
Fig. 9 | DE-433
Fig. 16 | DE-434
Fig. 11 | DE-435
Fig. 03 | DE-436
Fig. 3A | DE-437
Fig. 5 | |
| | | DE-438
Fig. 6 | DE-439
Fig. 8 | DE-440
Fig. 8A | DE-441
Fig. 10 | DE-442
Fig. 12 | DE-443
Fig. 17 | DE-444
Fig. 17A |

EXPLORERS

- Зонды
- Sondes
- Zahnsonden
- Зонди
- Sondas
- المستكشفين

Probes Single End Solid Handle 6mm, length 150mm



DE-445
Fig. 6

DE-448
Fig. 8

DE-447
Fig. 9

DE-448
Fig. 16

DE-449
Fig. 23

Probes Single Ended 6mm, length 150mm

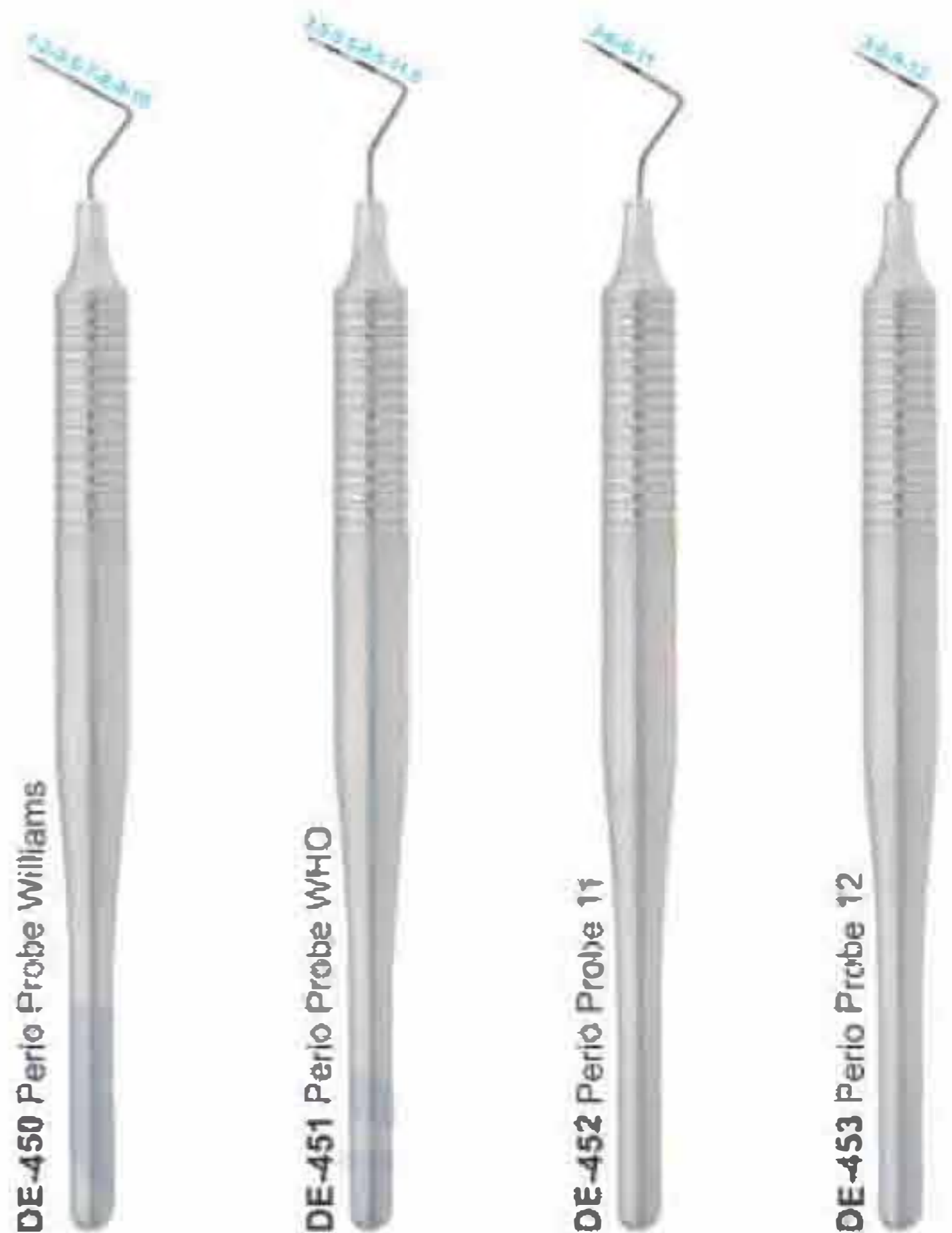

DE-450 Perio Probe Williams

DE-451 Perio Probe WHO

DE-452 Perio Probe 11

DE-453 Perio Probe 12

Examination kit Set of 3 Pieces



DE-454
Probe

DE-455
Mirror

DE-456
College Forcep
15cm

Examination Set of 4 Pieces



Examination Set of 4 Pieces



DE-457
Exp.23/17-A

DE-458
Exavators

DE-459
Tweezers

DE-460
Mouth Mirror

INCHES
0 1 2 3 4 5 6 7 8 9

**EXPLORERS INSTRUMENTS
SOLID HANDLE 6MM, LENGTH 170MM**

- Зонды
 - Sondes
 - Zahnsonden
- Зонди
 - Sondas
 - مستكافين



Double-Ended Explorers

Explorers-Single-End

EXPLORERS

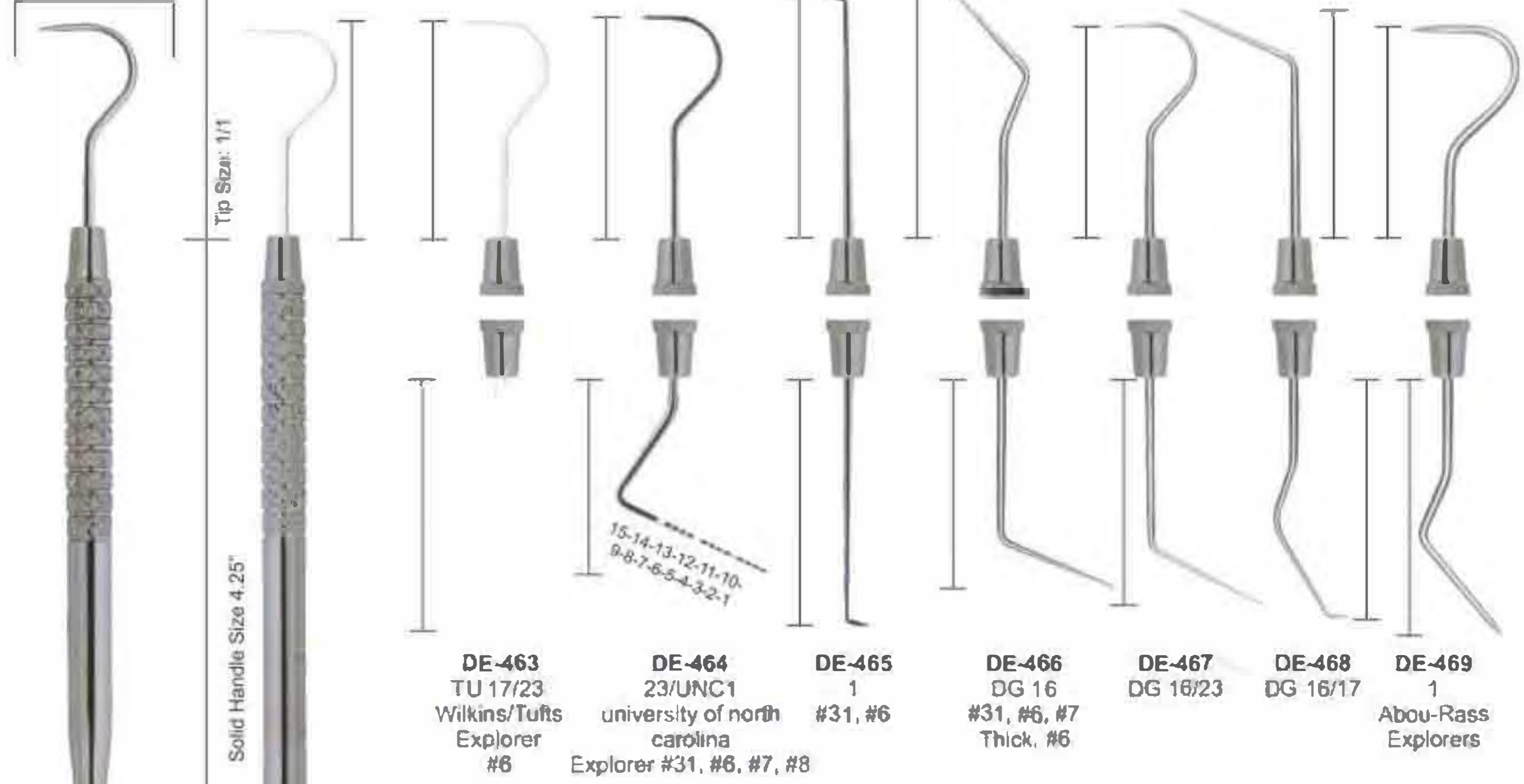

DE-463 TU 17/23 Wilkins/Tufts Explorer #6	DE-464 23/UNC1 university of north carolina Explorer #31, #6, #7, #8	DE-465 1 #31, #6	DE-466 DG 16 #31, #6, #7 Thick, #6	DE-467 DG 16/23	DE-468 DG 16/17	DE-469 1 Abou-Rass Explorers
--	---	-------------------------------	--	---------------------------	---------------------------	--

Probes Double Ended 6mm, length 170mm



DE-470 Goldman Fox Fig.17	DE-471 University of Michigan Fig.17	DE-472 Williams Fig.17	DE-473 Goldman Fox Fig.16	DE-474 University of Michigan Fig.16	DE-475 Williams Fig.16
--	--	-------------------------------------	--	--	-------------------------------------

EXPLORERS

- Зонды
- Sondes
- Zahnsonden
- Зонди
- Sondas
- المستظفين

Pointed Probes Single Ended Handle 6mm, length 150mm

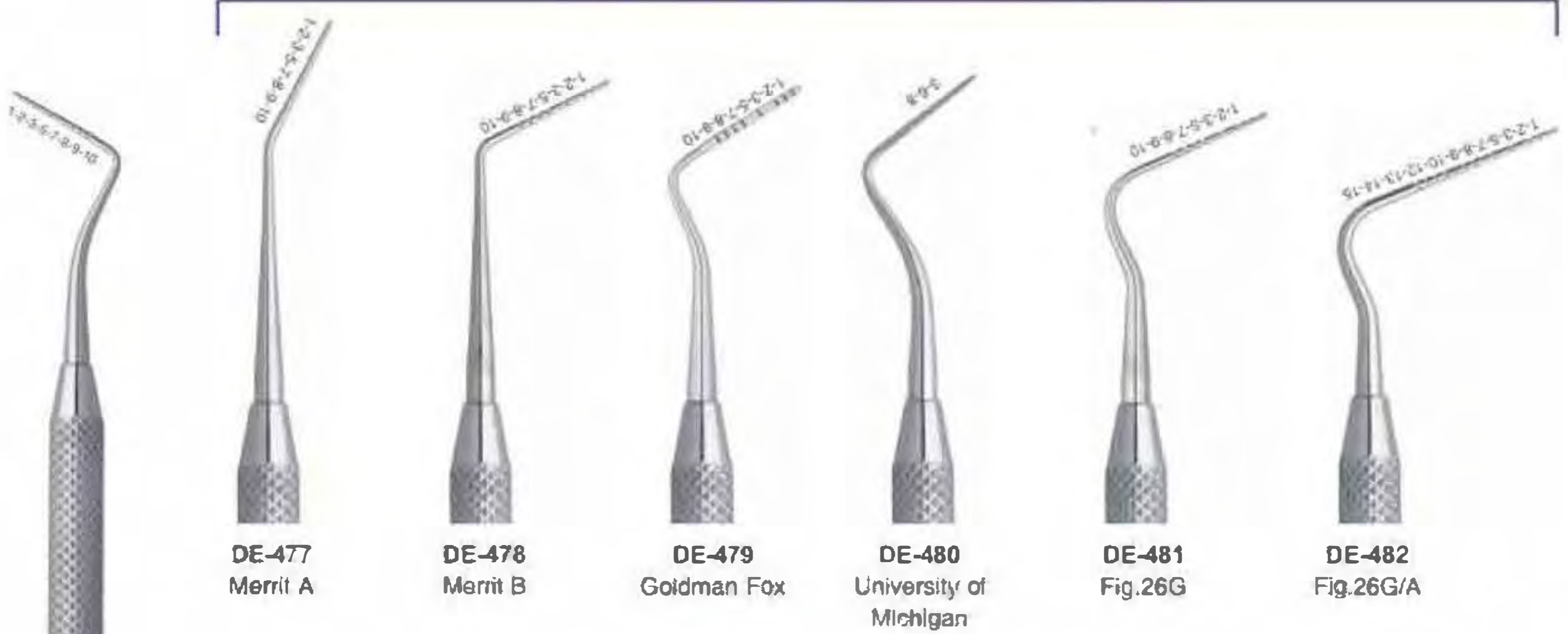

Pointed Probes Double Ended Handle 6mm, length 170mm



- Инструменты пародонтологические
- Instruments pour la parodontologie
- Instrumente für die Parodontologie

- Инструменти пародонтологічні
- Instrumentos para periodoncia
- المعكوك اللثة

PERIODONTAL SET OF 10 PIECES SOLID HANDLE 6MM LENGTH 170MM



EXPLORERS

- Зонды
- Sondes
- Zahnsonden
- Зонди
- Sondas
- المستكشفين

WILLIAM PROBE SET DOUBLE ENDED WITH HOLLOW HANDLE 9.5MM, LENGTH 170MM
 CERAMIC COATED HANDLE

Proper care must be given during cleaning, sharpening and sterilization to preserve design and integrity and to prolong usefulness. Do not expose instruments to sterilization temperatures above 350 F/177 C or to higher than recommended chemical concentrations.

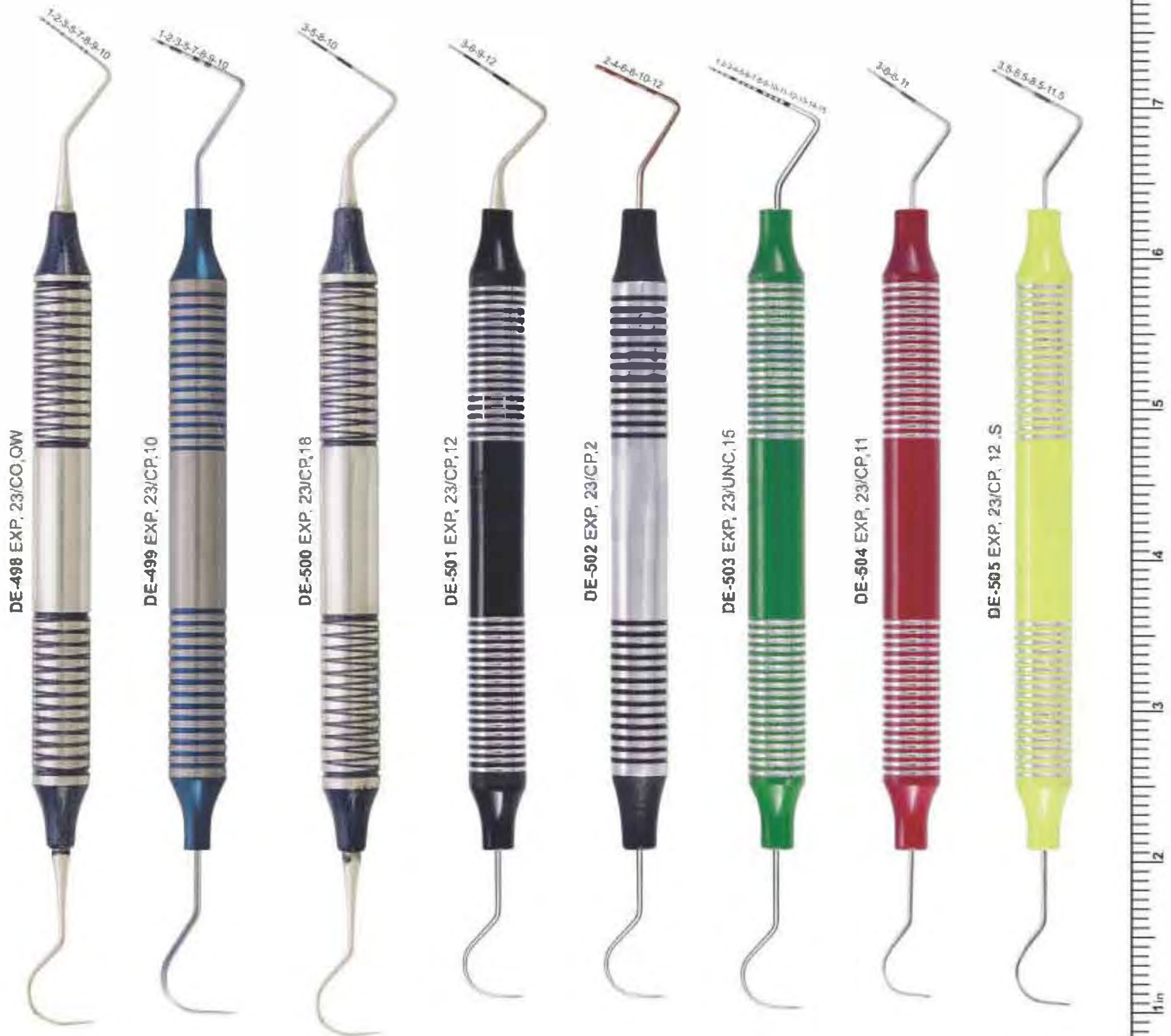

- Инструменты пародонтологические
- Instruments pour la parodontologie
- Instrumente für die Parodontologie

- Инструменти пародонтологични
- instrumentos para periodoncia
- المعكوك اللثة

**PERIODONTAL INSTRUMENTS SET OF 11 PCS
SOLID HANDLE 6MM, LENGTH 170MM**



CURETTES

- Кюрети
- Curetas
- K rletton
- Кюрети
- Curette
- كرتس

GRACEY SET OF 7 PCS HOLLOW HANDLE 9.5MM, LENGTH 170MM

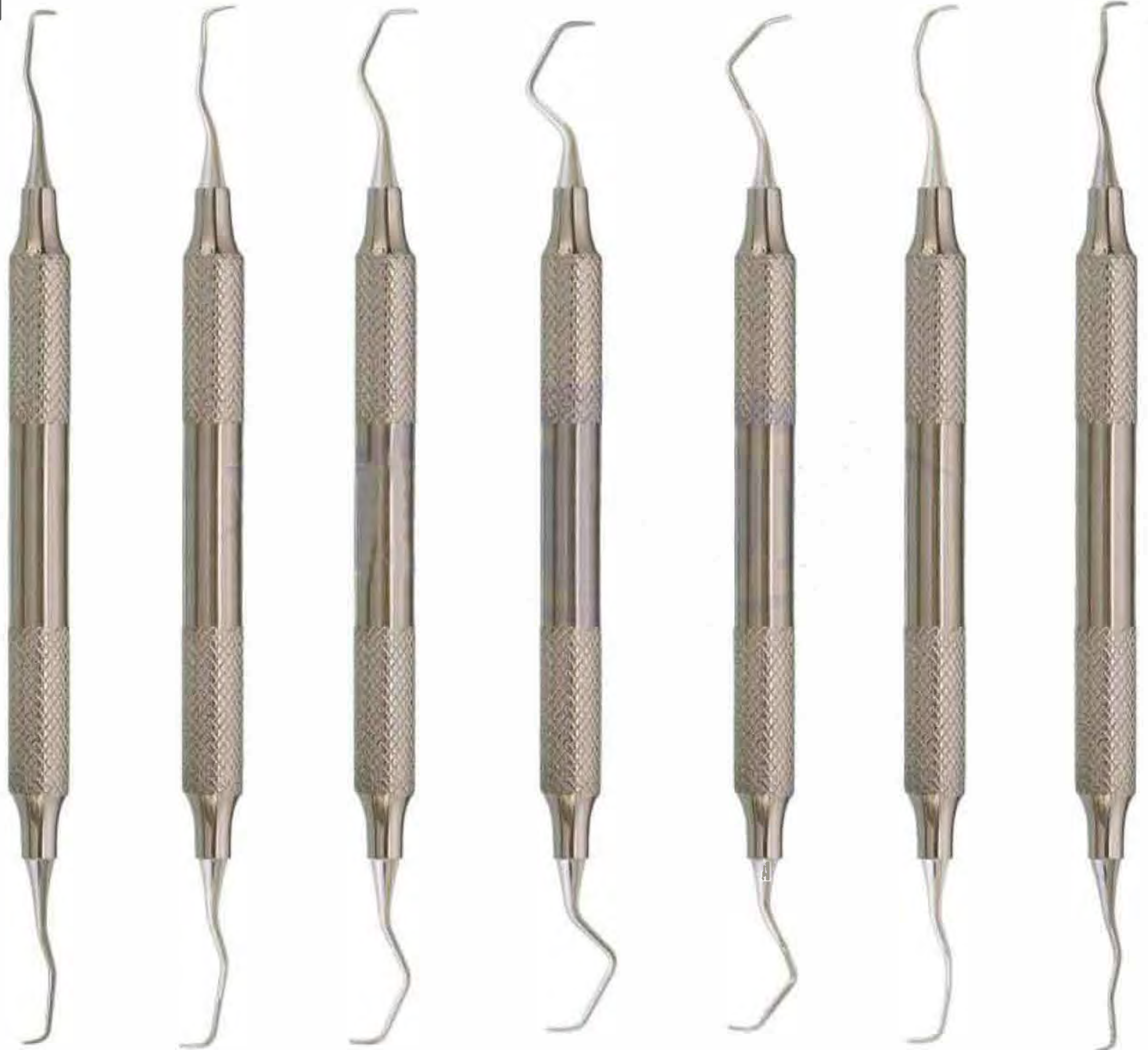

DE-517
GRACEY
1/2

DE-518
GRACEY
3/4

DE-519
GRACEY
5/6

DE-520
GRACEY
7/8

DE-521
GRACEY
9/10

DE-522
GRACEY
11/12

DE-523
GRACEY
13/14

INCHES
0 1 2 3 4 5 6 7 8 9

- Кюретки
 - Curetas
 - Kürotten
- Кюретки
 - Curette
 - كرتيس

GRACEY SET OF 7 PCS
HOLLOW HANDLE 9.5MM, LENGTH 170MM WITH SILICON GRIP

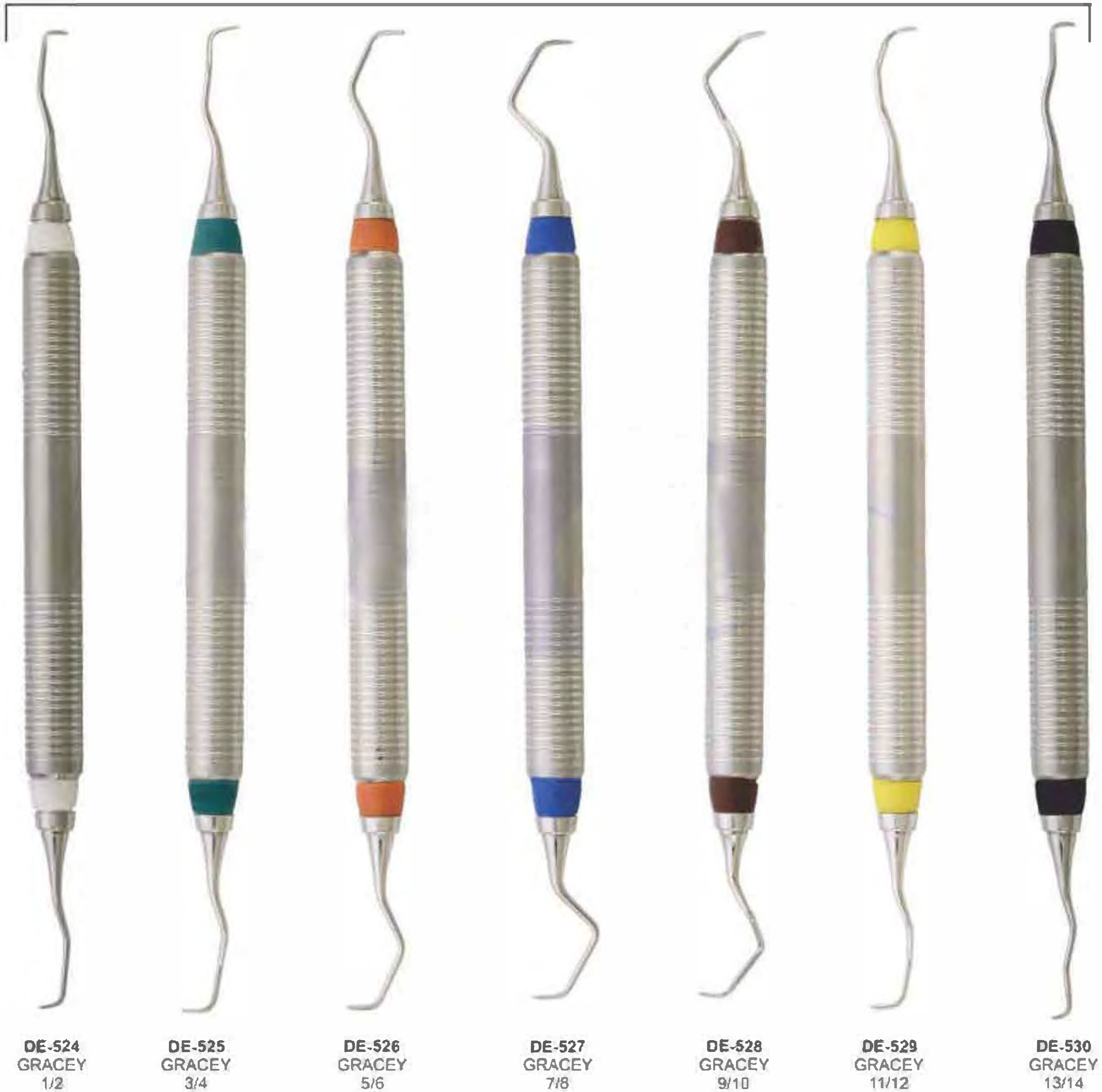

DE-524
GRACEY
1/2

DE-525
GRACEY
3/4

DE-526
GRACEY
5/6

DE-527
GRACEY
7/8

DE-528
GRACEY
9/10

DE-529
GRACEY
11/12

DE-530
GRACEY
13/14

CURETTES

- Кюрети
- Curetas
- K rotton
- Кюрети
- Curette
- كرتس

GRACEY MINI FIVE

HOLLOW HANDLE 9.5MM, LENGTH 170MM
CERAMIC COATED HANDLE



DE-531 Gracey 1/2
DE-532 Gracey 3/4
DE-533 Gracey 5/6
DE-534 Gracey 7/8
DE-535 Gracey 11/12
DE-536 Gracey 13/14

GRACEY AFTER FIVE

HOLLOW HANDLE 9.5MM, LENGTH 170MM
CERAMIC COATED HANDLE

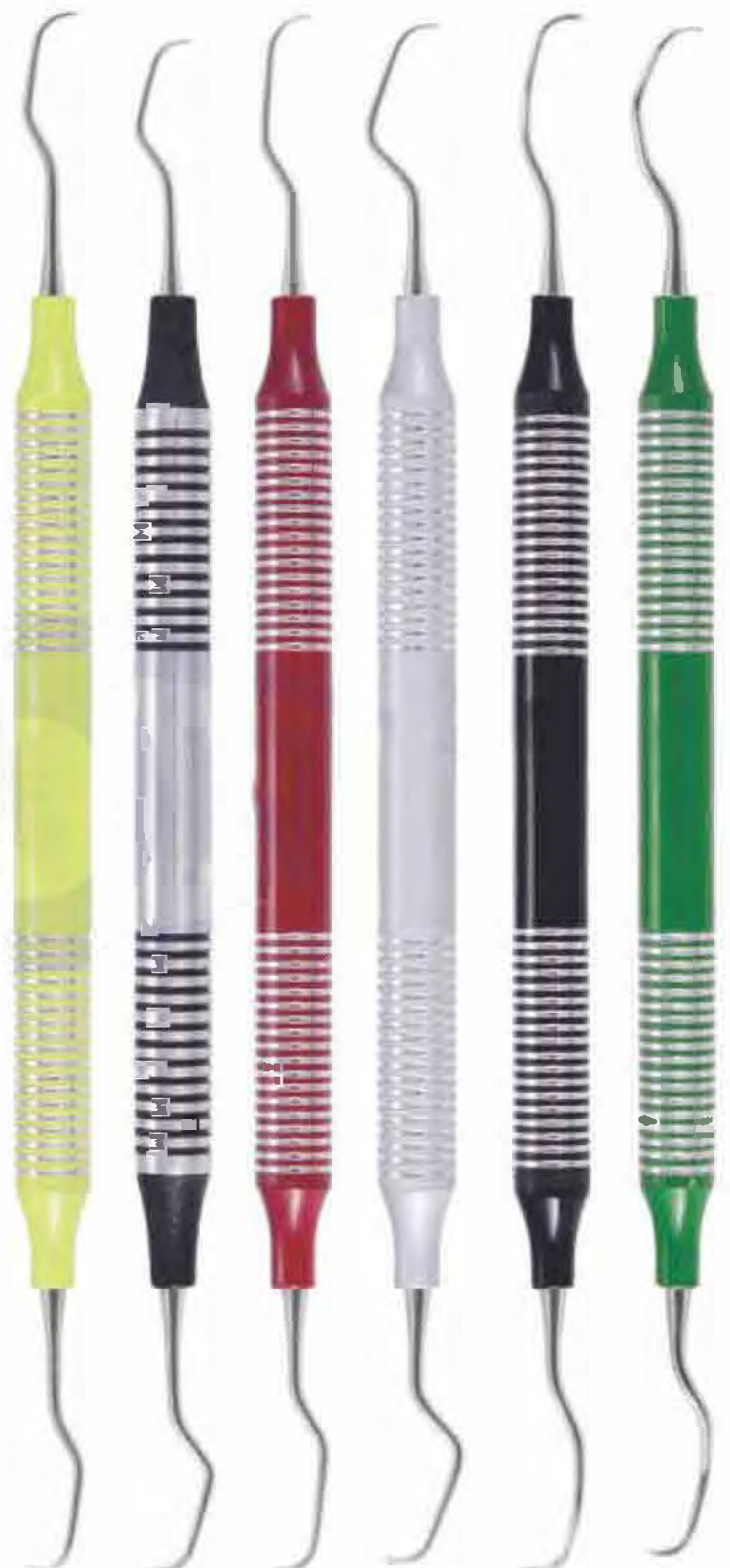

DE-537 Gracey 1/2 AF
DE-538 Gracey 3/4 AF
DE-539 Gracey 5/6 AF
DE-540 Gracey 7/8 AF
DE-541 Gracey 11/12 AF
DE-542 Gracey 13/14 AF

Proper care must be given during cleaning, sharpening and sterilization to preserve design and integrity and to prolong usefulness. Do not expose instruments to sterilization temperatures above 350 F/177 C or to higher than recommended chemical concentrations.



- Кюретки
- Curetas
- Küretten
- كورتيس
- Кюретки
- Curette
- كورتيس

**GRACEY CURETTE
HOLLOW HANDLE 10MM, LENGTH 170MM**

Cureters Set of 8 Pieces

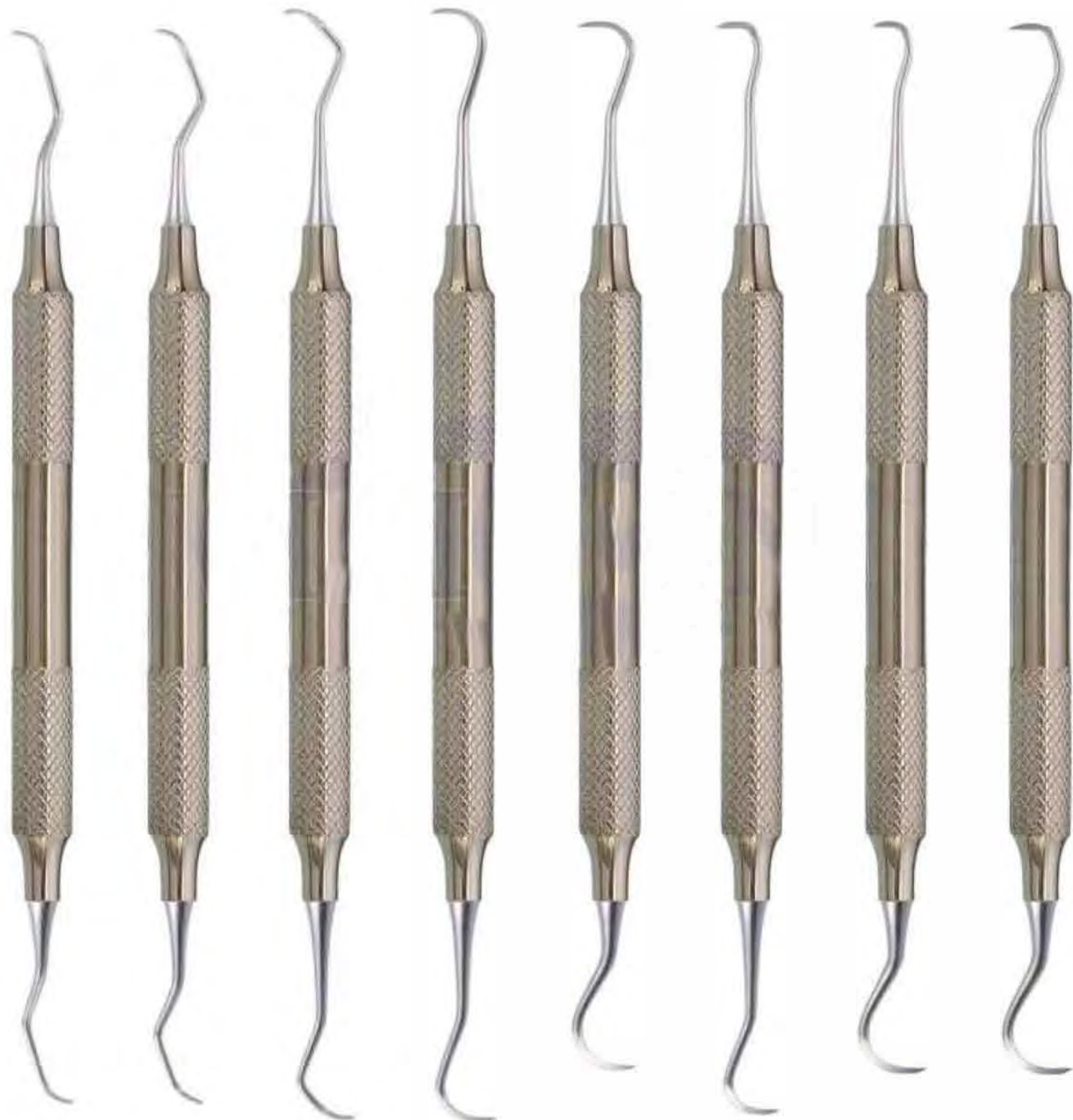

DE-543
Curette
Columbia
2L-2R

DE-544
Curette
Columbia
4L-4R

DE-545
Curette
McCall
13S-14S

DE-546
H6-H7
Scaler
Sickle

DE-547
H5-U15
Scaler
Sickle

DE-548
H5-13
Scaler
Sickle

DE-549
U15-30
Scaler
Sickle

DE-550
U15-33
Scaler
Sickle



FILLING INSTRUMENTS

- Инструменты для реставрации
- Instruments pour plombage
- Füllungsinstrumente (mit Kontrawinkel)
- Инструменты для реставрації
- Instrumentos para obturaciones
- ملء الصلوك

FILLING INSTRUMENTS (Gold Pointed) SOLID HANDLE 6MM, LENGTH 170MM



Solid Handle Size 4.25"

Tip Size: 1/1

DE-551 1.5mm / 1.5mm

DE-552 2.0mm / 2.0mm

DE-553 2.0mm / 2.0mm

DE-554 2.5mm / 2.5mm

DE-555 1.3mm / 0.9mm

DE-556 1.6mm / 1.3mm

DE-557 2.4mm / 1.8mm

DE-558 2.4mm / 2.0mm

DE-559 1.3mm / 1.5mm

DE-560 1.8mm / 1.2mm

Filling Instrument, spatula 6 mm solid handle, length 170 mm,

Filling Instrument 6 mm length 175 mm,

Filling Instrument, ball 6 mm length 170 mm,

Filling Instrument, ball / spatula 6 mm length 175 mm,











Filling Instrument, plan / plan 6 mm length 165 mm,

EXPLORERS INSTRUMENTS
SOLID HANDLE 6MM, LENGTH 170MM

- Зонды
 - Sondes
 - Zahnsonden
- Зонди
 - Sondas
 - زوندي



PLUGGERS

 DE-561 1/3 21mm	 DE-562 5/7 21mm	 DE-563 9/11 21mm	 DE-564 1/2 Root Canal Plugger	 DE-565 3/4 Root Canal Plugger	
 DE-566 MA57 27mm	 DE-567 GP3 30mm	 DE-568 ISO Size 30 24mm	 DE-569 ISO Size 40 24mm	 DE-570 ISO Size 50 24mm	 DE-571 ISO Size 60 24mm

PERIODONTAL PROBES

- Зонды пародонтологические
- Sondes paradontales
- sonda paradontali
- зонди пародонтологічні
- Sondas paradontales
- المسهر اللثة

SPREADERS

HEAT CARRIERS

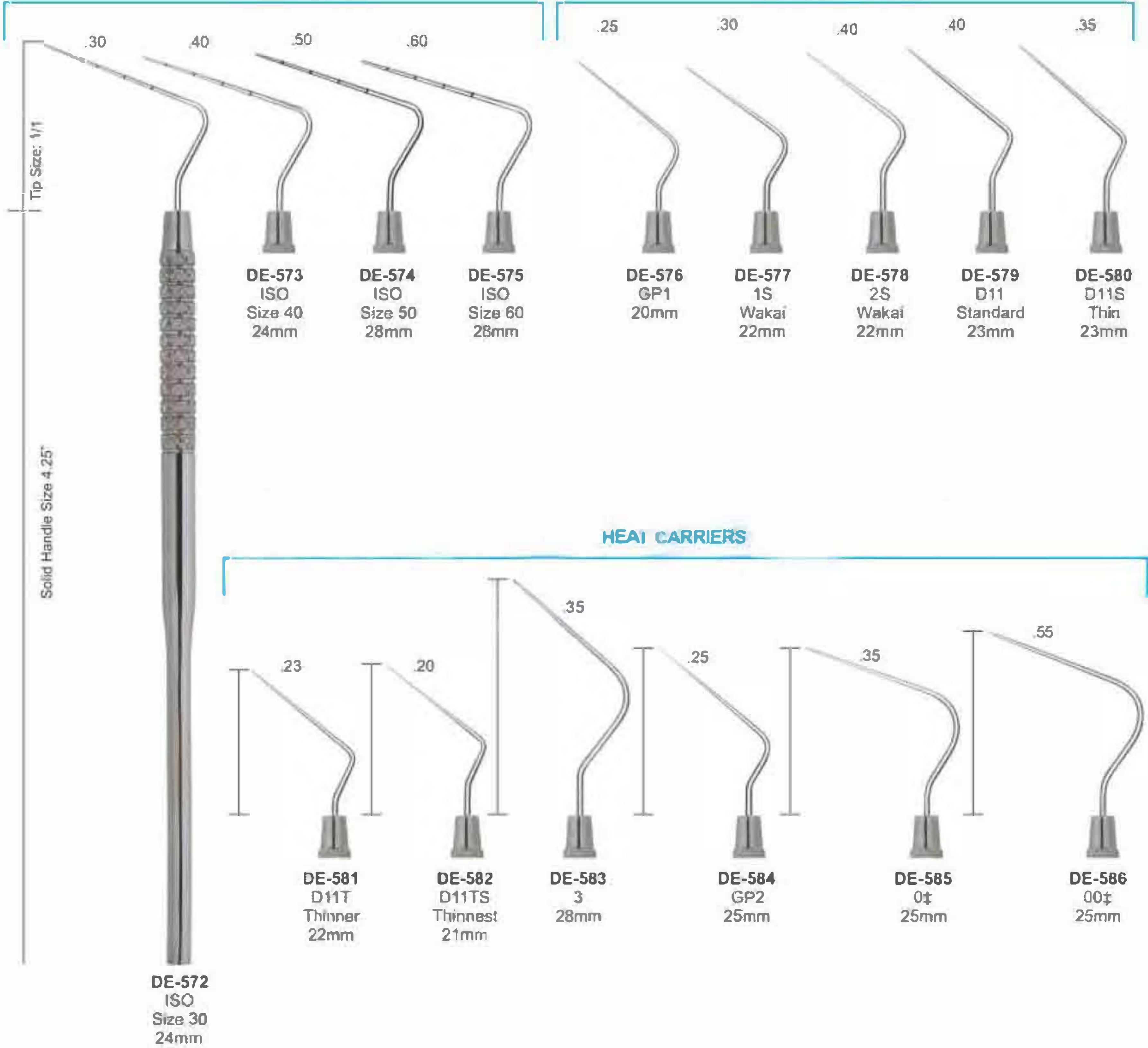

Tip Size: 1/16"

Solid Handle Size 4.25"

Model	ISO / Standard	Size	Length
DE-572	ISO	Size 30	24mm
DE-573	ISO	Size 40	24mm
DE-574	ISO	Size 50	28mm
DE-575	ISO	Size 60	28mm
DE-576	GP1	20mm	20mm
DE-577	1S Wakai	22mm	22mm
DE-578	2S Wakai	22mm	22mm
DE-579	D11 Standard	23mm	23mm
DE-580	D11S Thin	23mm	23mm
DE-581	D11T Thinner	22mm	23mm
DE-582	D11TS Thinnest	21mm	20mm
DE-583	3	28mm	35mm
DE-584	GP2	25mm	25mm
DE-585	0†	25mm	35mm
DE-586	00†	25mm	55mm

HEAT CARRIERS



INCHES

- Зонды пародонтологические
- Sondes paradontales
- sonda paradontal

- зонди пародонтологічні
- Sondas paradontales
- المقاسر اللثة

ENDODONTICS INSTRUMENTS

ANTERIOR



DE-587
BA
29mm

DE-588
8 1/2A
29mm

DE-589
9A
29mm

DE-590
9 1/2A
29mm

DE-591
10A
29mm

DE-592
10 1/2A
29mm

DE-593
11A
29mm

DE-594
11 1/2A
29mm

DE-595
12A
29mm

LUKS



DE-596
L1
18mm

DE-597
L2
18mm

DE-598
L3
18mm

DE-599
L4
18mm

PERIODONTAL PROBES

- Зонды пародонтологические
- Sondes paradontales
- sonda paradontali
- зонди пародонтологічні
- Sondas paradontales
- المسبار ثلثة

ENDODONTICS INSTRUMENTS SOLID HANDLE 6MM, LENGTH 170MM POSTERIOR

RETRO FILLING PLUGGERS

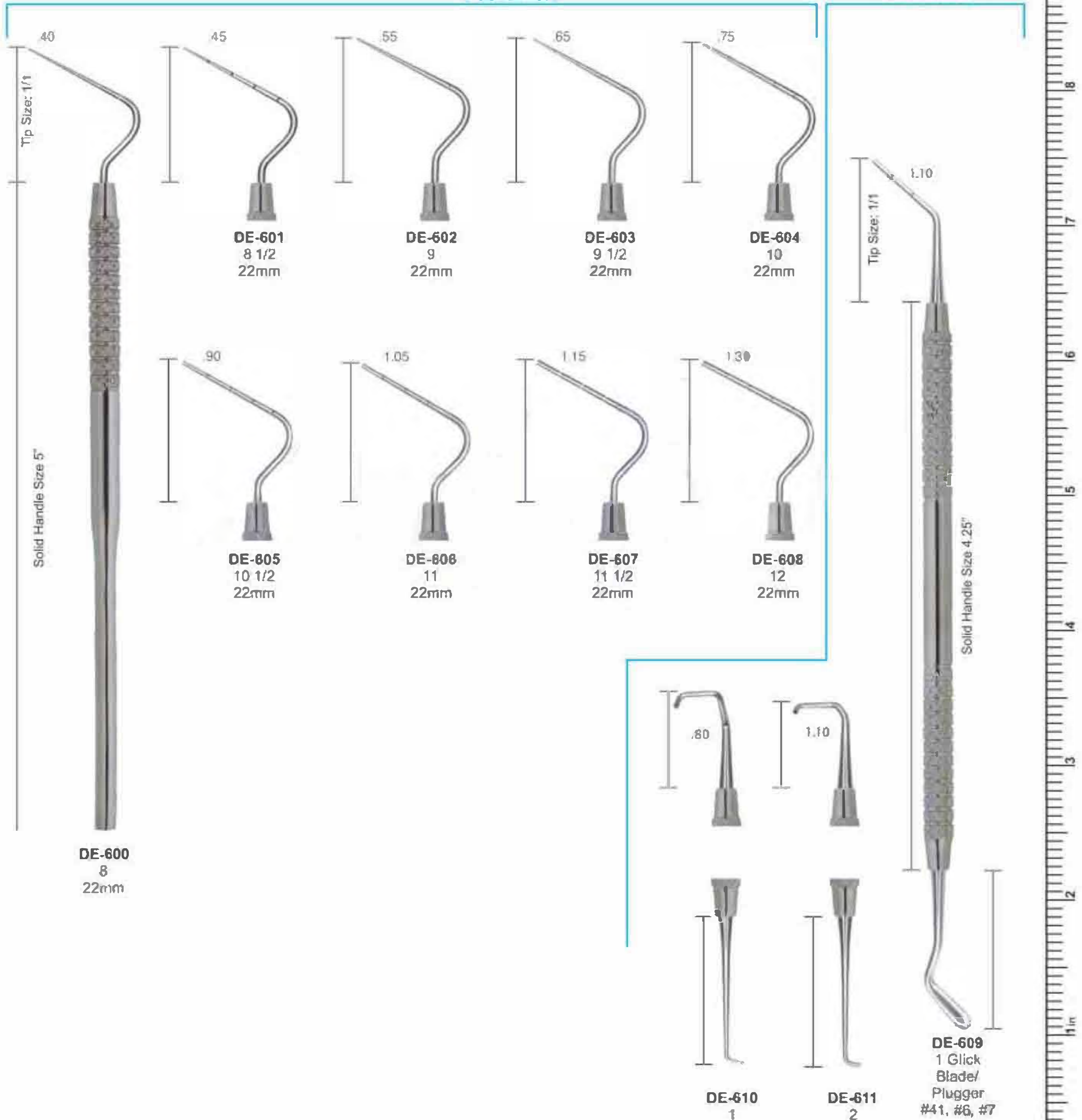

The image displays a collection of dental instruments. On the left, a large instrument with a 5-inch solid handle is shown. To its right, a grid of 12 curved instruments (DE-601 to DE-608) is arranged in two rows. Each instrument is labeled with its tip size and handle length. Below this grid, two more curved instruments (DE-610 and DE-611) are shown. To the right of the main grid, a retro filling plugger (DE-609) with a 4.25-inch solid handle is shown. At the bottom right, two more instruments (DE-610 and DE-611) are shown. A vertical ruler on the far right indicates measurements in inches from 0 to 9.

Instrument	Tip Size	Handle Length
DE-600	8	22mm
DE-601	8 1/2	22mm
DE-602	9	22mm
DE-603	9 1/2	22mm
DE-604	10	22mm
DE-605	10 1/2	22mm
DE-606	11	22mm
DE-607	11 1/2	22mm
DE-608	12	22mm
DE-609	1 Glick Blade/ Plugger	#41, #6, #7
DE-610	1	
DE-611	2	

- Инструменты для реставрации
- Instruments pour plombage
- Füllungsinstrumente (mit Kontrawinkel)

- Инструменты для реставрации
- Instrumentos para obturaciones
- ملء لاصقوك

COMPOSITE/PLASTIC FILLING INSTRUMENTS SOLID HANDLE 6MM, LENGTH 170MM

POSTERIOR

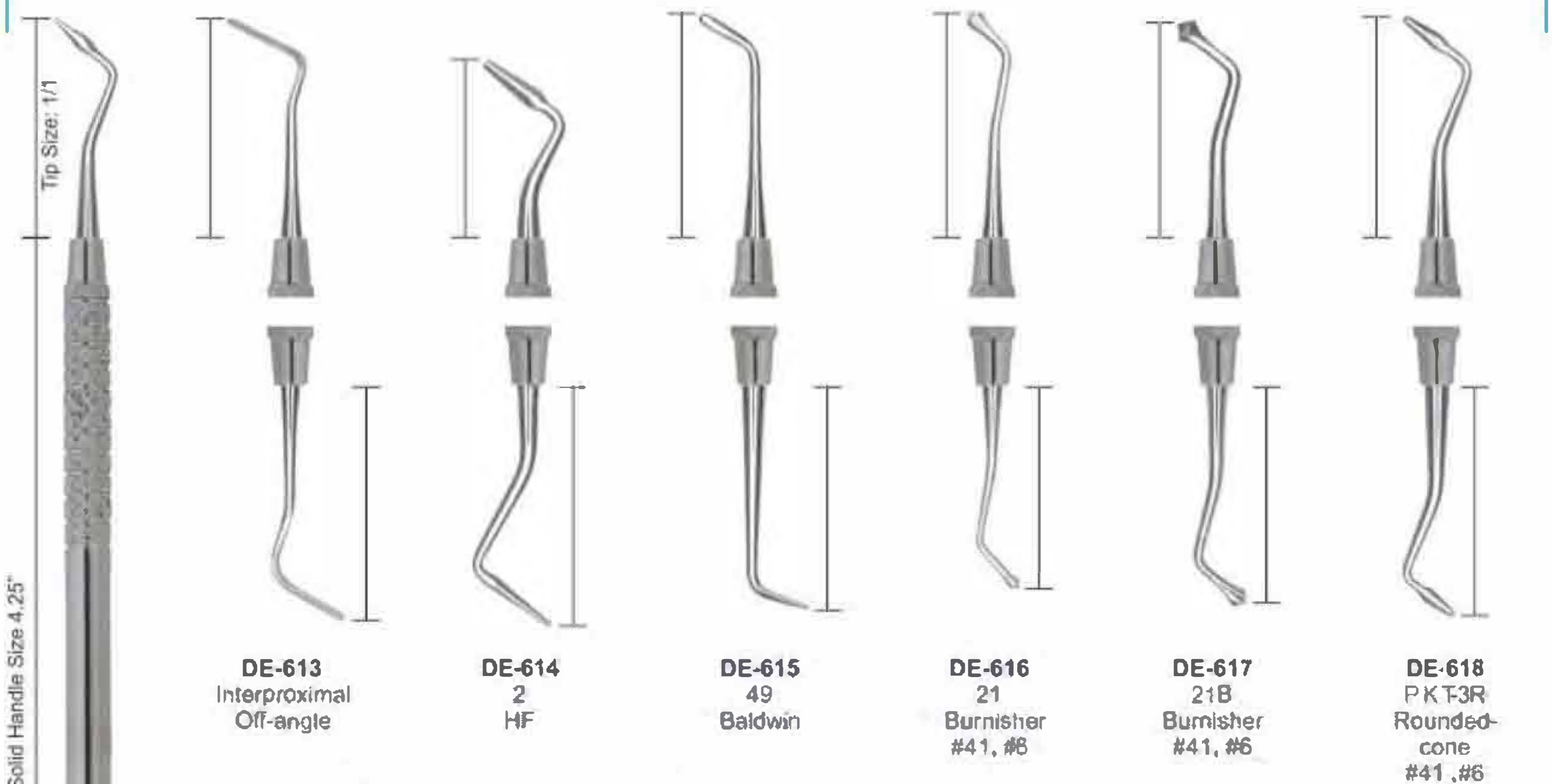

UNIVERSAL FILLING INSTRUMENTS

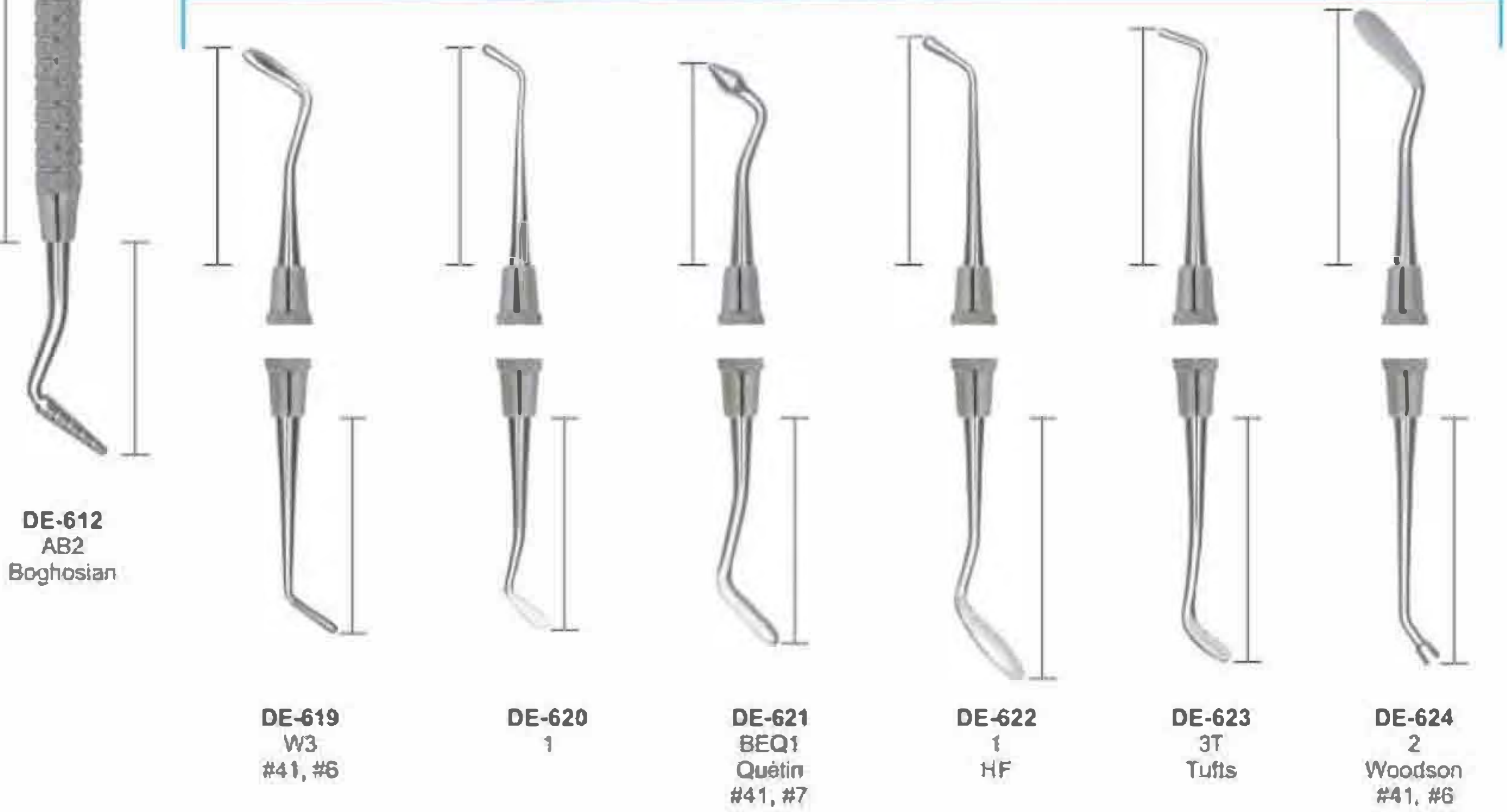

FILLING INSTRUMENTS

- Инструменты для реставрации
 - Instruments pour plombage
 - Füllungsinstrumente (mit Kontrawinkel)
- Инструменты для реставрації
 - Instrumentos para obturaciones
 - ملء انسكوك

COMPOSITE/PLASTIC FILLING INSTRUMENTS SOLID HANDLE 6MM, LENGTH 170MM

BLACK

PLUGGERS/CONDENSERS

Hollenback

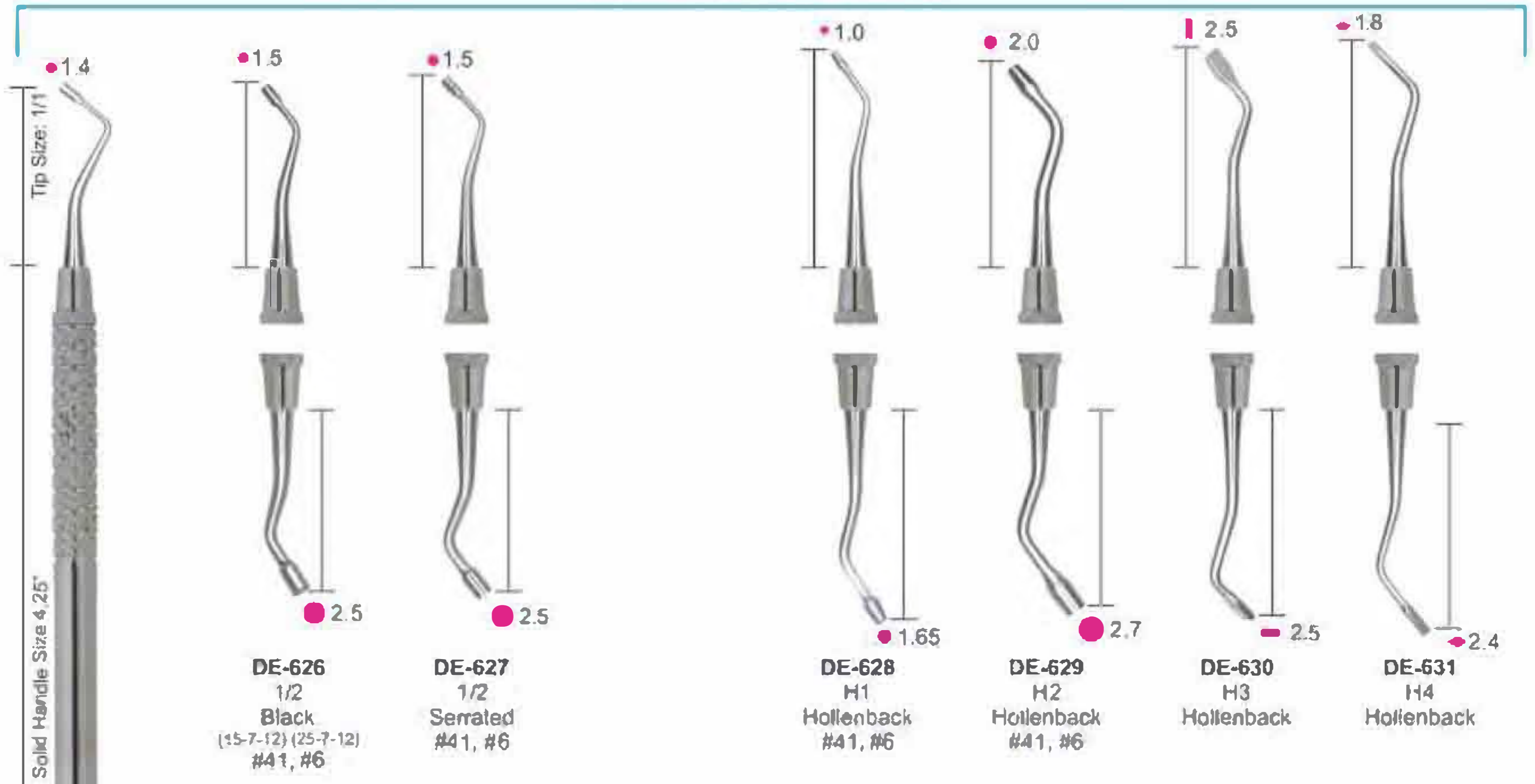

MARQUETTE CONDENSER

MORTONSON

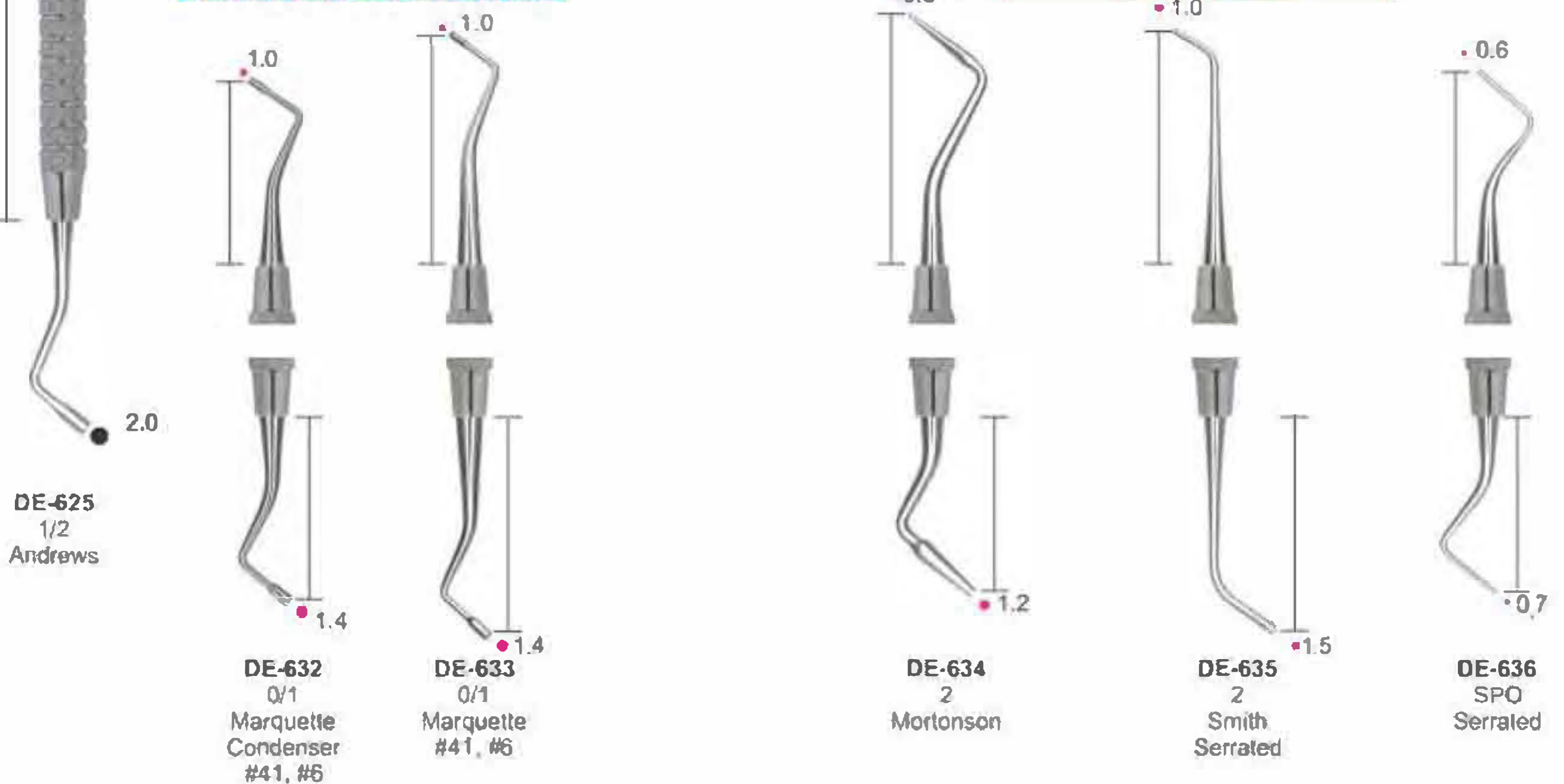

- Инструменты для реставрации
- Instruments pour plombage
- Füllungsinstrumente (mit Kontrawinkel)

- Инструменты для реставрации
- Instrumentos para obturaciones
- ملء للصقوك

PLUGGERS/CONDENSERS

RESTORATIVE INSTRUMENTS SOLID HANDLE 6MM, LENGTH 170MM



DE-638
2M
Markley



DE-639
4M
Markley

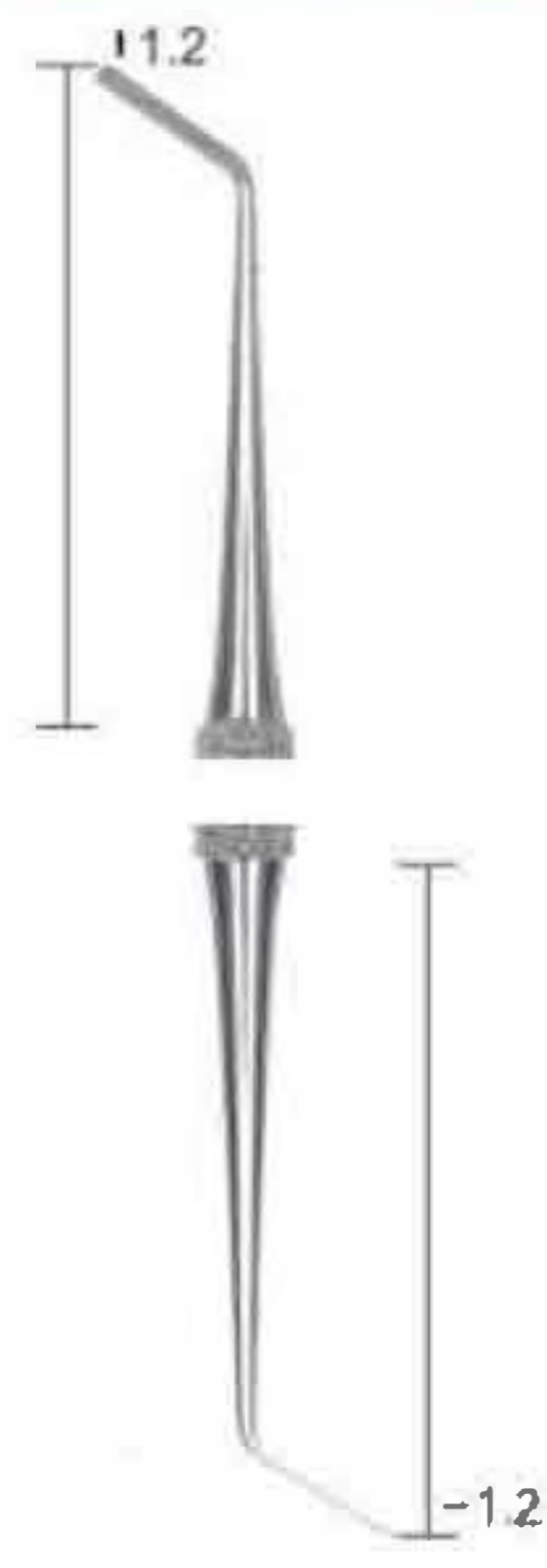

DE-640
5M
Markley



DE-641
6M
Markley

PLUGGERS/CONDENSERS



DE-642
1
Oregon
#41, #6



DE-643
2
Oregon
#41, #6



DE-644
3
Oregon



DE-645
4
Oregon
#41, #6



DE-646
1
Ward



DE-647
2
Ward

DE-637
1M
Markley

FILLING INSTRUMENTS

- Инструменты для реставрации
- Instruments pour plombage
- Füllungsinstrumente (mit Kontrawinkel)

- Инструменты для реставрації
- Instrumentos para obturaciones
- ملء الصلوك

RESTORATIVE INSTRUMENTS SOLID HANDLE 6MM, LENGTH 170MM

Tanner Filling Instruments

Back Action Filling Instruments

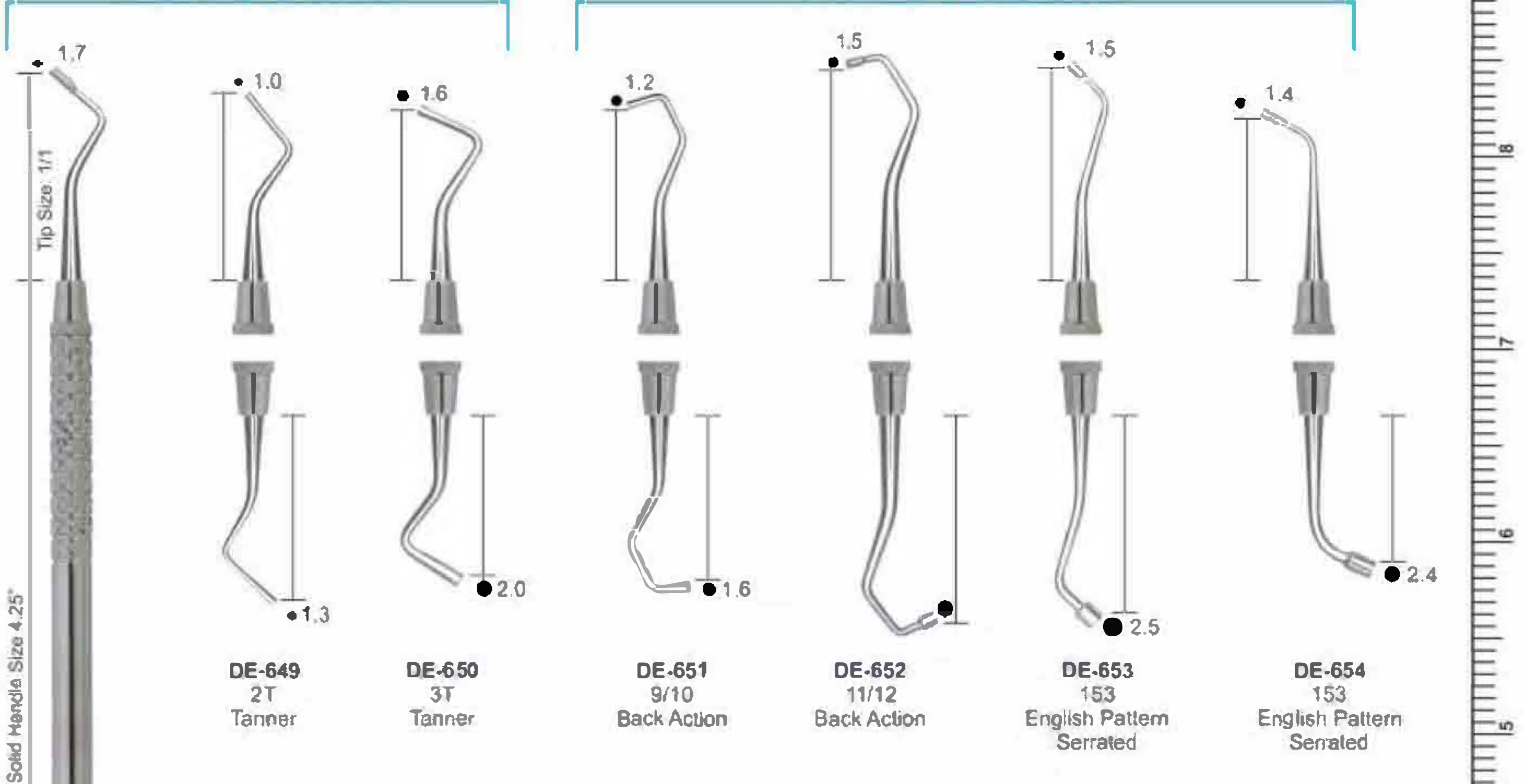

Solid Handle Size 4.25"

Tip Size: 1/1

Instrument	Tip Size	Label
DE-649	1.7	2T Tanner
DE-650	1.0	3T Tanner
DE-651	1.2	9/10 Back Action
DE-652	1.5	11/12 Back Action
DE-653	1.5	153 English Pattern Serrated
DE-654	1.4	153 English Pattern Serrated
DE-648	1.7	1T Tanner
DE-648	2.3	1T Tanner
DE-655	1.6	18 #41, #6
DE-656	1.3	26/27S #41, #6
DE-657	3.1	27/29 #41, #6, #7, #8
DE-658	2.6	2 Double-End
DE-659	1.5	2 Double-End
DE-660	1.7	21 #41, #6
DE-661	2.7	21B #41, #6, #8
DE-662	1.3	2 Ladmore

BURNISHERS

BALL

BEAVERTAIL

ACORN

LADMORE

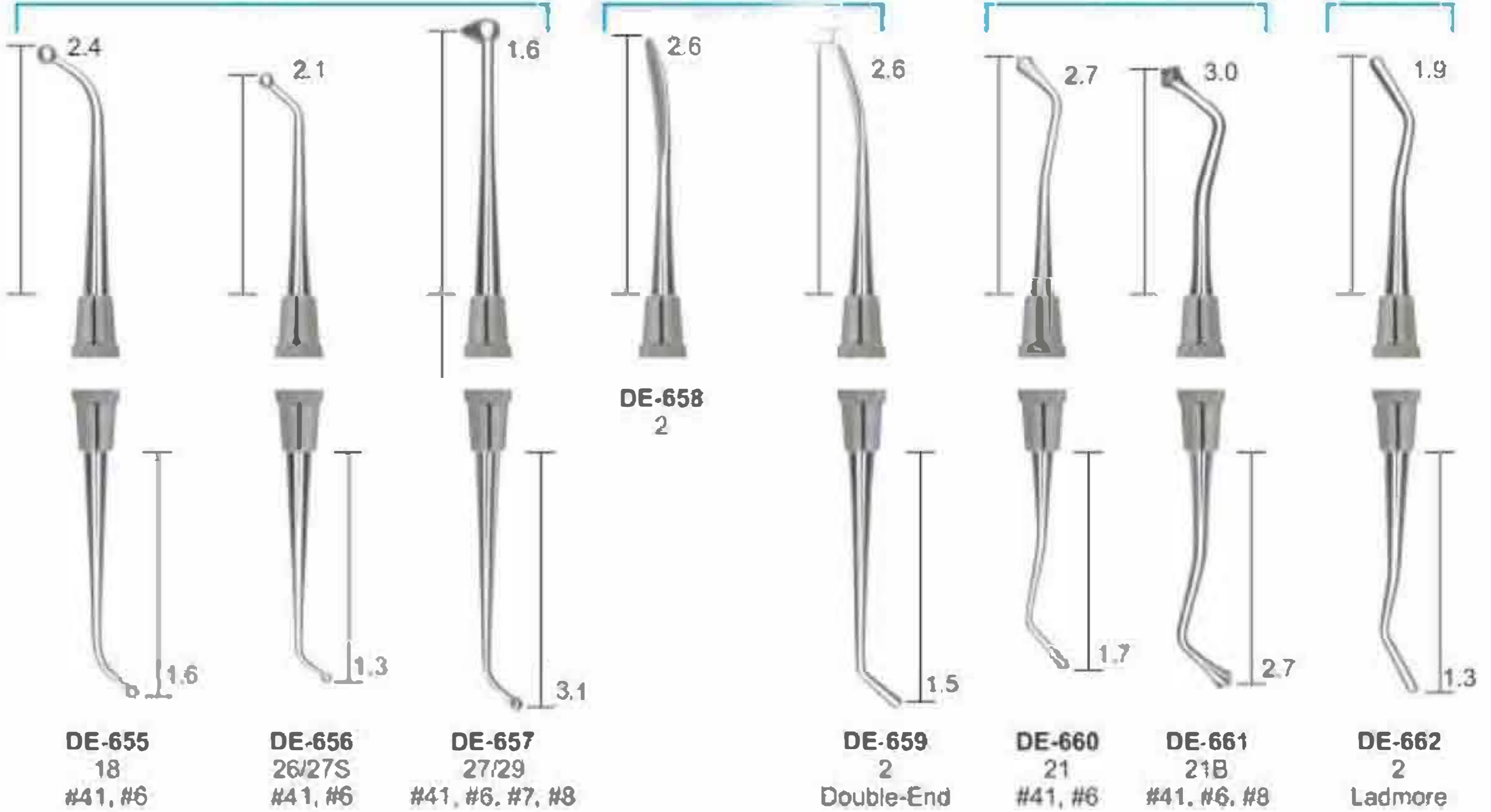

Instrument	Tip Size	Label
DE-655	2.4	18 #41, #6
DE-656	2.1	26/27S #41, #6
DE-657	1.6	27/29 #41, #6, #7, #8
DE-658	2.6	2 Double-End
DE-659	2.6	2 Double-End
DE-660	2.7	21 #41, #6
DE-661	3.0	21B #41, #6, #8
DE-662	1.9	2 Ladmore

- Инструменты для реставрации
- Instruments pour plombage
- Füllungsinstrumente (mit Kontrawinkel)

- Инструменты для реставрации
- Instrumentos para obturaciones
- ملء الصنوك

RESTORATIVE INSTRUMENTS SOLID HANDLE 6MM, LENGTH 170MM

BURNISHERS

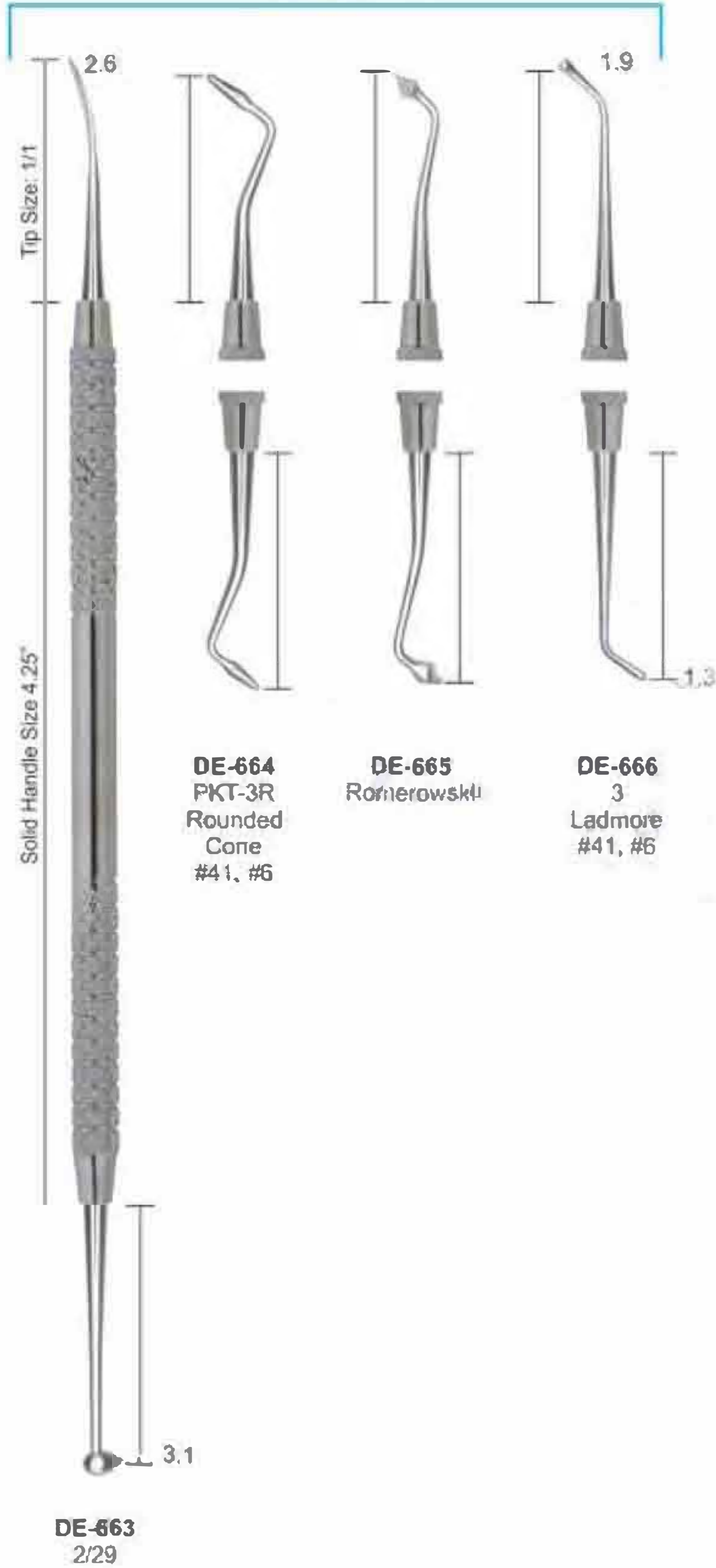

PERIODONTAL FILES



FILLING INSTRUMENTS

- Инструменты для реставрации
 - Instruments pour plombage
 - Füllungsinstrumente (mit Kontrawinkel)
- Instrumenti для реставрації
 - Instrumentos para obturaciones
 - ملء للصكوك

BURNISHER FILLING INSTRUMENTS

COMPOSITE/PLASTIC FILLING INSTRUMENTS
SOLID HANDLE 6MM, LENGTH 170MM

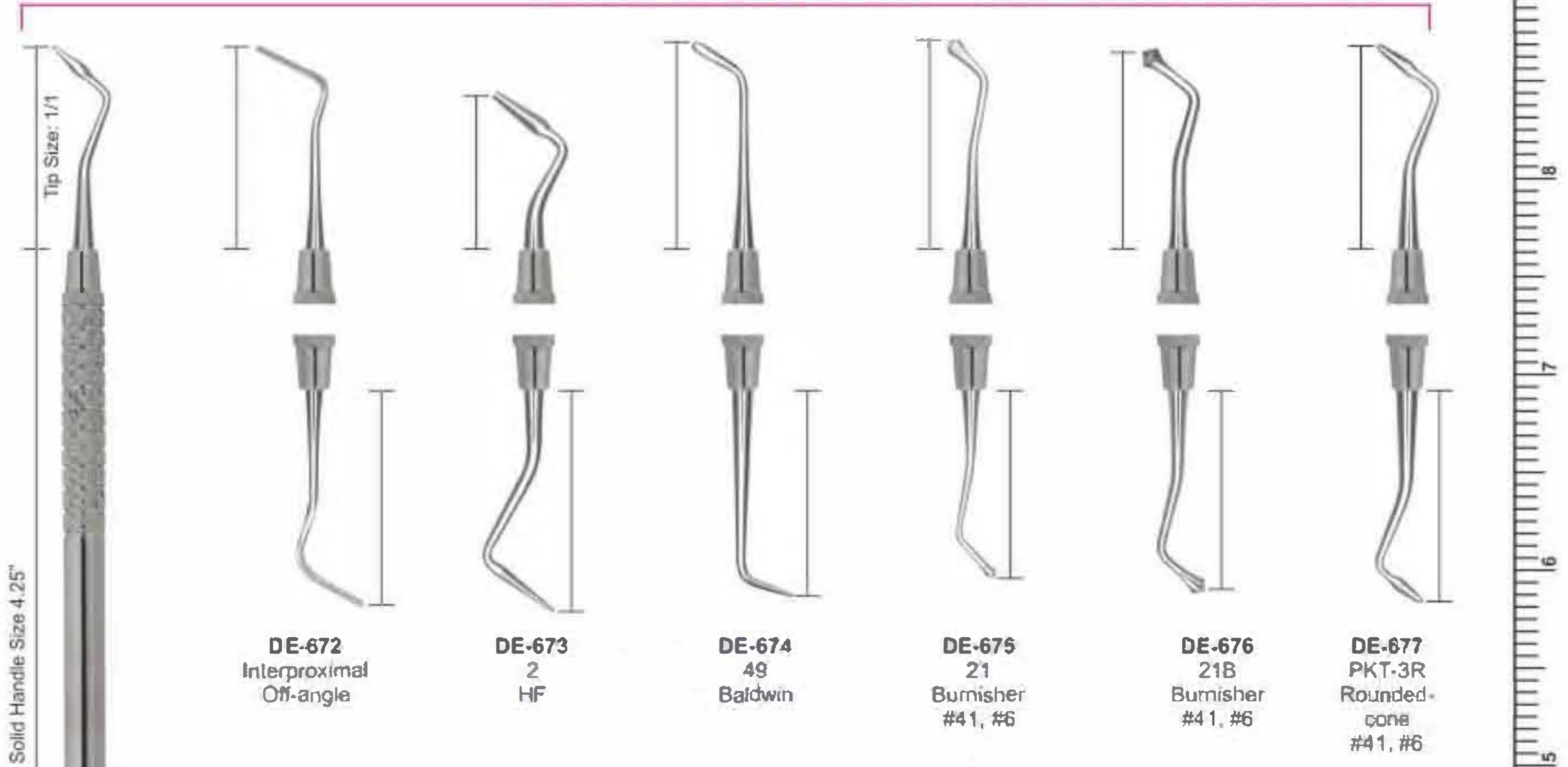

UNIVERSAL FILLING INSTRUMENTS



- Инструменты для реставрации
- Instruments pour plombage
- Füllungsinstrumente (mit Kontrawinkel)

- Instrumenti для реставрації
- Instrumentos para obturaciones
- ملء الصمغ

**FILLING INSTRUMENTS
SOLID HANDLE 6MM, LENGTH 170MM**



DE-684
Filling
Instrument

DE-694

DE-695

DE-696

DE-697

DE-698
Mortensen

DE-699

DE-700

DE-701

LINING APPLICATOR

DE-693
Lining Applicator
Double End

PERIODONTAL INSTRUMENTS

- Инструменты пародонтологические
 - Instruments pour la parodontologie
 - Instrumente für die Parodontologie
- Инструменти пародонтологічні
 - Instrumentos para periodoncia
 - المكيوى اللثة

SICKLE SCALERS INSTRUMENTS SOLID HANDLE 6MM, LENGTH 170MM

SICKLE SCALERS



DE-724
H6/H7†
Hygienist
#2, #4, #6,
#7, #8, #9

DE-725
6/7
Goldman
#2, #4, #6,
#7, #8

DE-726
U15
Towner
#24, #6,
#7, #8

DE-727
H5/U15
Hygienist-
Towner
#2, #4, #6

DE-728
U15/30
Towner-
Jacquette
#2, #4, #6
#7, #8, #9

DE-729
H15/33†
Hygienist-
Jacquette
#2, #4, #6
#7, #8, #9

DE-730
U15/33
Towner-
Jacquette
#2, #4, #6
#7, #8, #9

- Инструменты пародонтологические
- Instruments pour la parodontologie
- Instrumente für die Parodontologie

- Инструменти пародонтологични
- Instrumentos para periodoncia
- المسكوك اللثة

PERIODONTAL INSTRUMENTS SOLID HANDLE 6MM, LENGTH 170MM

JACQUETTE SCALERS

CRANE-KAPLAN



Solid Handle Size 4.25"

DE-731
30/33
Hygienist
Jacquette
#2, #4, #6,
#7, #8, #9

DE-732
31/32
Jacquette
#2, #4, #6,
#7, #8, #9

DE-733
34/35
Jacquette
#2, #4, #6,
#7, #8, #9

DE-734
H3/H4
Jacquette
#2, #4, #6,

DE-735
14/15
Posterior
Jacquette
#2, #4, #6,

DE-736
CK-6
#2, #4, #6.

PERIODONTAL INSTRUMENTS

- Инструменты пародонтологические
 - Instruments pour la parodontologie
 - Instrumente für die Parodontologie
- Інструменти пародонтологічні
 - Instrumentos para periodoncía
 - أشكوت للثة

PERIODONTAL INSTRUMENTS SOLID HANDLE 6MM. LENGTH 170MM SCALER/CURETTE SETS



DE-737
11/12
Scaler
#2, #6,
#7, #8

DE-738
11A/12A
Scaler
#2, #4, #6.

DE-739
11/12S
Modied
McCall
#4, #6

DE-740
13S/14S
Pointed
Curette
#2, #4, #6
#7, #8, #9

DE-741
MTC 13/14
Pointed
Curette
#4, #6

DE-742
17S/18S
Curette
#2, #4, #6
#7, #8, #9

DE-743
19/20
Curette
#2

- Кюрети
- Curetas
- Kuretten
- Кюрети
- Curette
- كرتيس



SCALER/CURETTE SETS

GOLDMAN-FOX SET

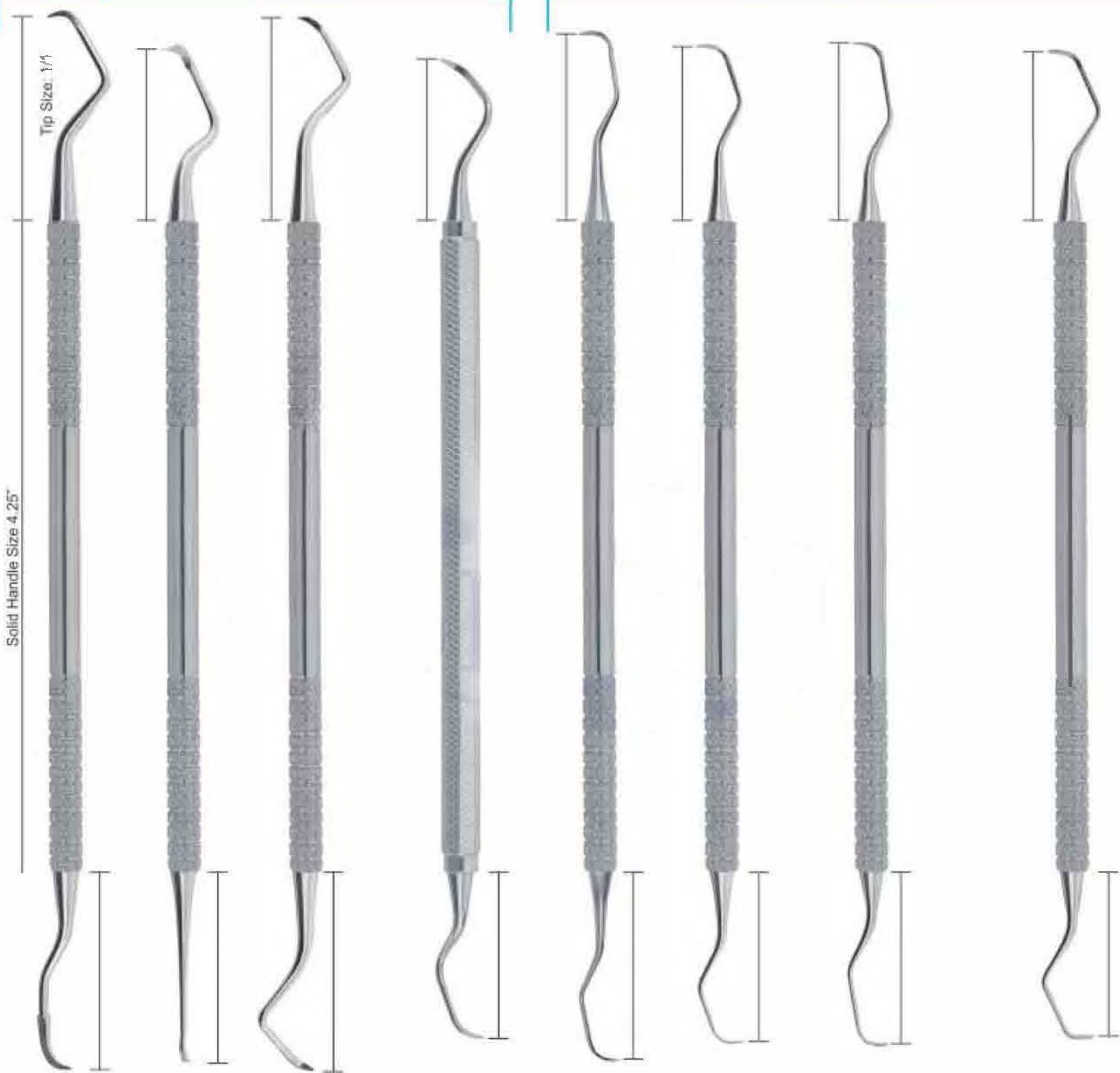

DE-744
103/106
#4, #6

DE-744A
104/105
Hob/Chisel
#4, #6

DE-745
107/108
#2, #4, #6
#7, #8

DE-746
107/108S
Modied
#2, #4

DE-747
1/2
(shown)
#2, #4, #6
#7, #8, #9

DE-749
3/4†
(shown)
#2, #4, #6
#7, #8, #9

DE-751
5/6†
(shown)
#2, #4, #6
#7, #8, #9

DE-754
7/8†
(shown)
#2, #4, #6
#7, #8, #9

DE-748
1/2
Rigid
#2, #4, #6
#7, #8, #9

DE-750
3/4
Rigid
#2, #4, #6
#7, #8, #9

DE-752
5/6
Rigid
#2, #4, #6
#7, #8, #9

DE-753
5/6
Extra Rigid
#4, #6 #7,
#8

DE-755
7/8
Rigid
#2, #4, #6
#7, #8, #9

DE-756
7/8
Extra Rigid
#2, #4, #6
#7, #8, #9

**SCALER/CURETTE SETS INSTRUMENTS
SOLID HANDLE 6MM, LENGTH 170MM**

CURETTES

- Кюрети
- Curetas
- Küretten
- Кюрети
- Curette
- كرتير

GRACEY CURETTE INSTRUMENTS SOLID HANDLE 6MM, LENGTH 170MM
GRACEY CURETTES



DE-757
9/10†
(shown)
#2, #4, #6
#7, #8, #9

DE-759
11/12†
(shown)
#2, #4, #6
#7, #8, #9

DE-792
13/14†
(shown)
#2, #4, #6
#7, #8, #9

DE-765
15/16†
(shown)
#2, #4, #6
#7, #8, #9

DE-767
17/18
#2, #4, #6
#7, #8, #9

DE-758
9/10
Rigid
#2, #4, #6
#7, #8

DE-760
11/12
Rigid
#2, #4, #6
#7, #8, #9

DE-761
11/12
Extra Rigid
#4, #6 #7,
#8

DE-793 **DE-764**
13/14 13/14
Rigid Extra Rigid
#2, #4, #6 #4, #6 #7,
#7, #8, #9 #8

DE-766
15/16
Rigid
#2, #4, #6
#7, #8, #9

DE-768
17/18
Rigid
#2, #4, #6
#7, #8, #9

- Кюретки
- Curetas
- Kürotten
- Кюретки
- Curette
- كرتيس



**CURETTE INSTRUMENTS
HOLLOW HANDLE 8.5MM, LENGTH 170MM**

**CURETTE INSTRUMENTS
SOLID HANDLE 6MM, LENGTH 170MM**

**CURETTE INSTRUMENTS
SOLID HANDLE 6MM, LENGTH 170MM**



DE-769
Hemingway
2mm, 2mm

DE-770
Hemingway
3mm, 3mm

DE-771
Hemingway
4mm, 4mm

DE-772
Hemingway
2mm, 2mm

DE-773
Hemingway
3mm, 3mm

DE-774
Hemingway
4mm, 4mm

DE-775
Hemingway
2mm, 2mm

DE-776
Hemingway
3mm, 3mm

DE-777
Hemingway
4mm, 4mm

EXCAVATORS

- Экскаваторы
- Excavateurs
- Excavatoren
- عسكافاتوري
- Excavadoras
- حفارات

EXCAVATORS INSTRUMENTS SOLID HANDLE 6MM, LENGTH 170MM SPOONS

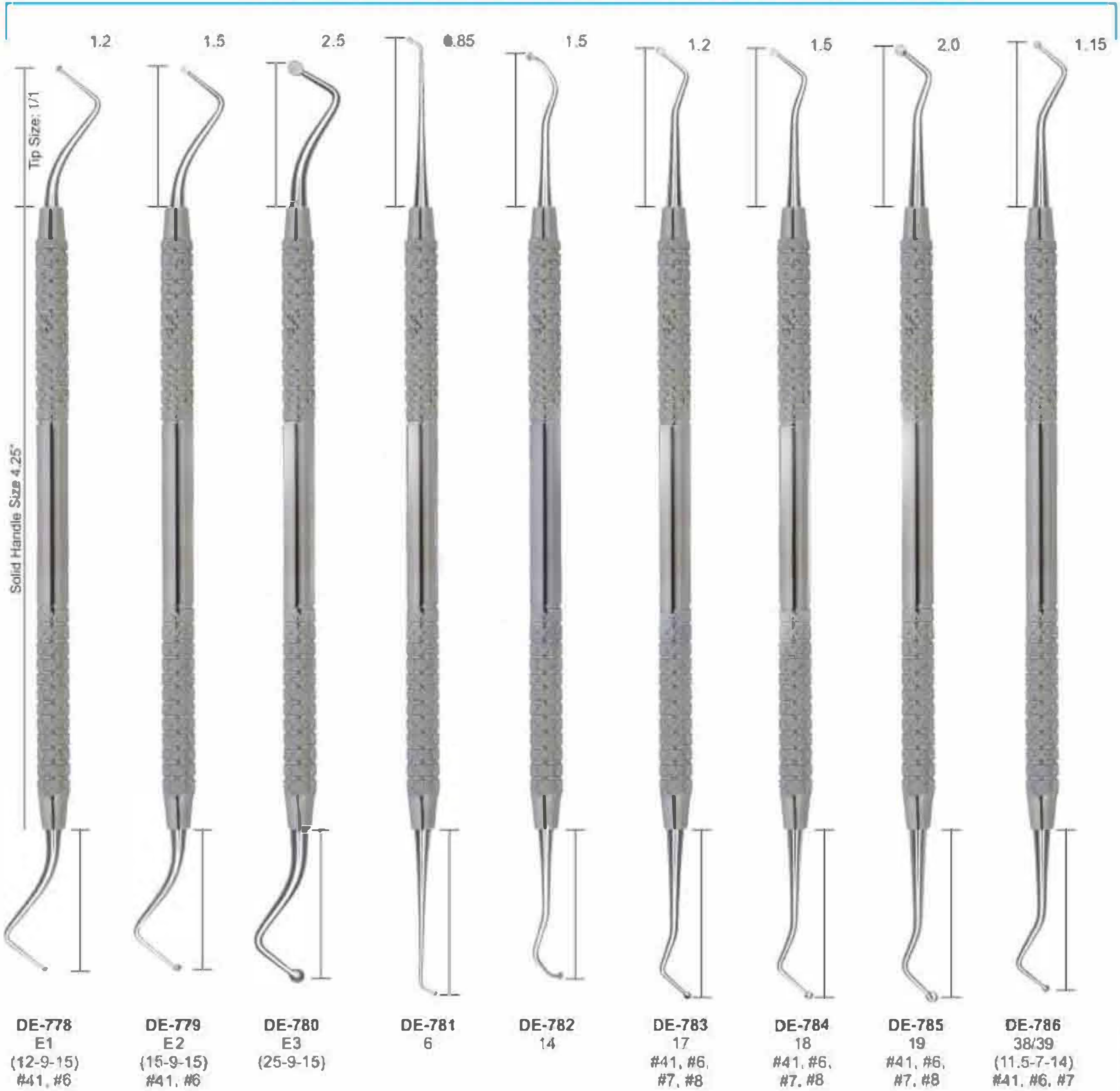









- Экскаваторы
- Excavateurs
- Excavatoren
- Excavatori
- Excavadores
- حفارات

EXCAVATORS INSTRUMENTS
SOLID HANDLE 6MM, LENGTH 170MM

OVAL SPOONS/DARBY-PERRY

EXCAVATORS



<p>Tip Size: 1/1</p> <p>Solid Handle Size 4.25"</p>	<p>1.2</p> 	<p>1.5</p> 	<p>1.8</p> 	<p>1.5</p> 	<p>1.5</p> 	<p>1.0</p> 	<p>1.3</p> 	<p>1.5</p> 	<p>2.0</p> 
	<p>DE-787 17W</p>	<p>DE-788 18W</p>	<p>DE-789 19W</p>	<p>DE-790 220/221 Darby-Perry #41, #6</p>	<p>DE-791 2 Glick</p>	<p>DE-792 31L #41, #6</p>	<p>DE-793 31W Oval Spoon</p>	<p>DE-794 32L #41, #6</p>	<p>DE-795 33L #41, #6</p>

EXCAVATORS

- Экскаваторы
- Excavateurs
- Excavatoreii
- Excavatori
- Excavadores
- حفارات

EXCAVATORS INSTRUMENTS SOLID HANDLE 6MM, LENGTH 170MM

BLADES

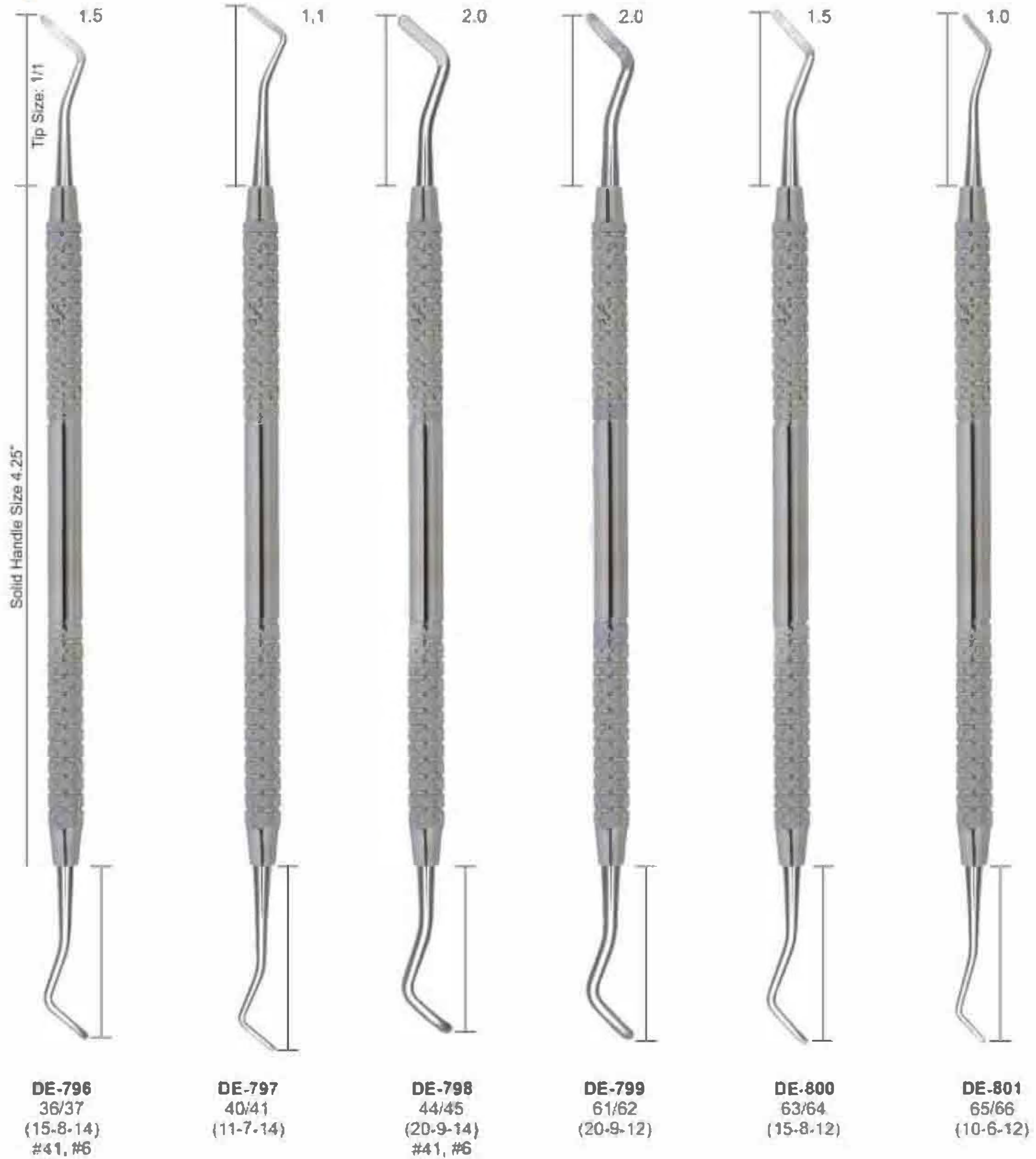

info@meditech-inst.com

INCHES

- Экскаваторы
- Excavateurs
- Excavatoren
- Excavatori
- Excavadores
- حفارات

EXCAVATORS INSTRUMENTS SOLID HANDLE 6MM, LENGTH 170MM

ENGLISH PATTERNS



DE-802
Goldstein
Interproximal
Excavator

DE-803
243

DE-804
244

DE-805
245

DE-806
246

DE-807
125/126
#41, #6

DE-808
127/128
#41, #6

DE-809
129/130
#41, #6

DE-810
131/132
#41, #6

DE-811
153/154

FILLING INSTRUMENTS

- Инструменты для реставрации
 - Instruments pour plombage
 - Füllungsinstrumente (mit Kontrawinkel)
- Instrumenti для реставрації
 - Instrumentos para obturaciones
 - ملء الصلوك

HATCHETS

RESTORATIVE INSTRUMENTS SOLID HANDLE 6MM. LENGTH 170MM

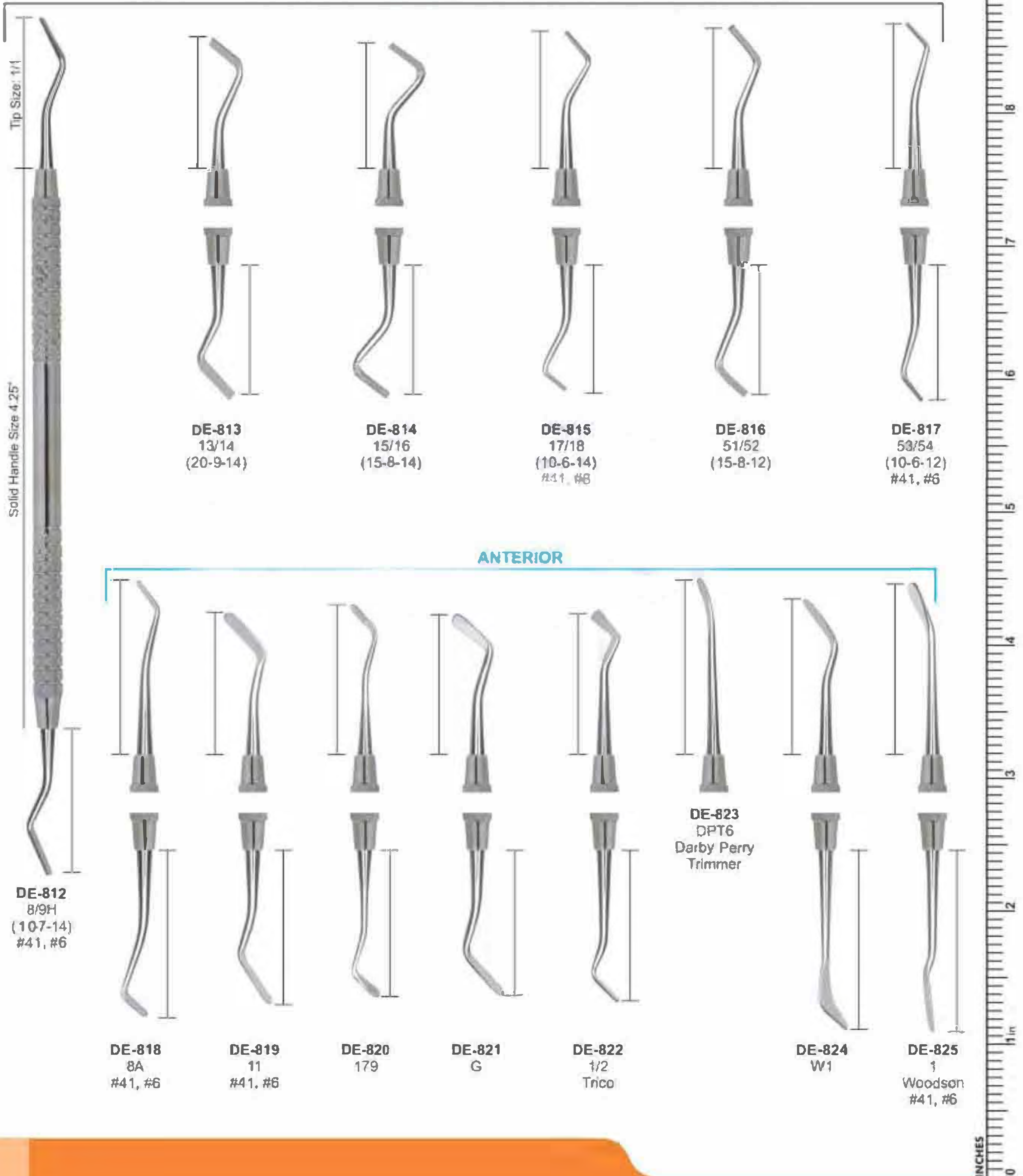

Tip Size: 1/4
Solid Handle Size 4.25"

Instrument	Tip Size	Handle Size
DE-813	13/14	(20-9-14)
DE-814	15/16	(15-8-14)
DE-815	17/18	(10-6-14) #41, #8
DE-816	51/52	(15-8-12)
DE-817	53/54	(10-6-12) #41, #6
DE-812	8/9H	(10-7-14) #41, #6
DE-818	8A	#41, #6
DE-819	11	#41, #6
DE-820	179	
DE-821	G	
DE-822	1/2	Trico
DE-823	DPT6	Darby Perry Trimmer
DE-824	W1	
DE-825	1	Woodson #41, #6

INCHES

- Инструменты для реставрации
- Инструменты для реставрації
- Instruments pour plombage
- Instrumentos para obturaciones
- Füllungsinstrumente (mit Kontrawinkel)
- ملء الصنوك

CARVERS

RESTORATIVE INSTRUMENTS SOLID HANDLE 6MM, LENGTH 170MM



DE-827
Inter-proximal
Off-Angle



DE-828
1/2-3
Hollenback
#41, #6,
#7, #8



DE-829
3S
Hollenback
#41, #6, #7



DE-830
3
Hollenback



DE-831
8
Wiland
Minn. IPC1
#41, #6, #7

TANNER

WALL

WARD



DE-826
Inter-proximal
#41, #6, #7



DE-832
3
Tanner



DE-833
4
Tanner



DE-834
5
Tanner



DE-835
6
Tanner



DE-836
1
Wall



DE-837
3
Wall



DE-838
1
Ward



DE-839
2
Ward

AMALGAM CARVERS

- Инструменты для реставрации
- Instruments pour amalgame
- Amalgampistolen
- Инструменти для реставрації
- instrumentos para amalgama
- تقطیع السقم

RESTORATIVE INSTRUMENTS

ANDREW SOLID HANDLE 6MM, LENGTH 170MM CLAPPISON/FRAHAM

HOLLENBACK

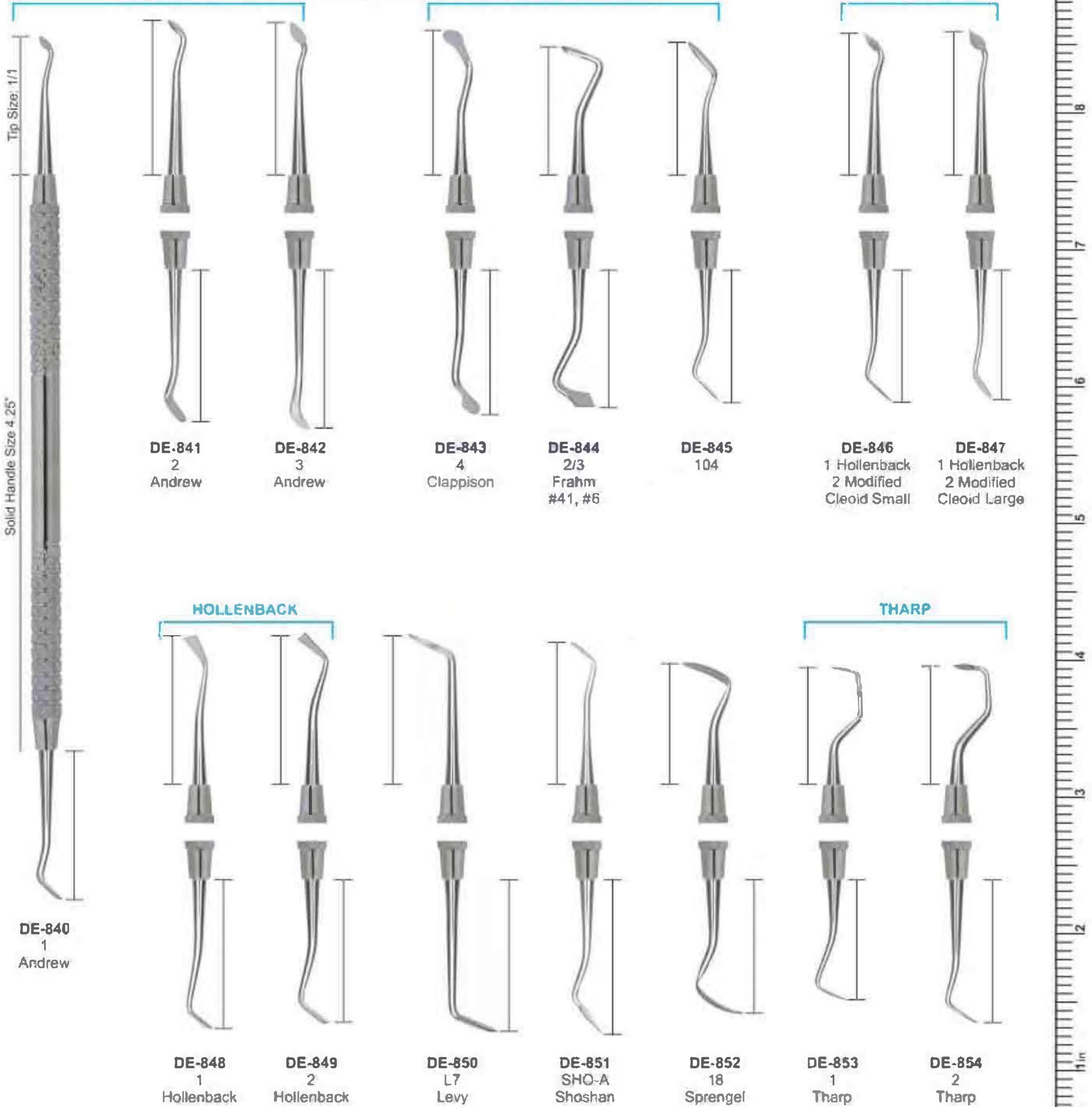

Tip Size: 1/1

Solid Handle Size 4.25"

DE-841
2
Andrew

DE-842
3
Andrew

DE-843
4
Clappison

DE-844
2/3
Frahm
#41, #6

DE-845
104

DE-846
1 Hollenback
2 Modified
Cleoid Small

DE-847
1 Hollenback
2 Modified
Cleoid Large

DE-840
1
Andrew

HOLLENBACK

HOLLENBACK

THARP

DE-848
1
Hollenback

DE-849
2
Hollenback

DE-850
L7
Levy

DE-851
SHO-A
Shoshan

DE-852
18
Sprengel

DE-853
1
Tharp

DE-854
2
Tharp

INCHES

FILLING INSTRUMENTS

- Инструменты для реставрации
- Instruments pour plombage
- Füllungsinstrumente (mit Kontrawinkel)

- Инструменти для реставрації
- Instrumentos para obturaciones
- ملء الصنوك

RESTORATIVE INSTRUMENTS
SOLID HANDLE 6MM, LENGTH 170MM

MARGIN TRIMMERS



DE-870
26
(13-95-8-14)
Distal



DE-871
27
(13-80-8-14)
Mesial



DE-872
28
(10-95-7-14)
Distal
#41, #6



DE-873
29
(10-80-7-14)
Mesial
#41, #6



DE-874
77/78
(15-95-8-12)
Distal



DE-875
79/80
(15-80-8-12)
Mesial

ANGLE FORMERS



DE-876
30/31
(12-80-5-8)



DE-877
32/33
(9-80-4-8)



DE-878
34/35
(7-80-2.5-9)

- Инструменты для реставрации
- Instruments a modelar
- Modellierinstrumente

- Инструменти для реставрації
- Instrumentos para modelar
- أدوات تقطع

P.K. THOMS WAXING INSTRUMENTS SOLID HANDLE 6MM, LENGTH 170MM

P.K. THOMAS WAXING INSTRUMENTS

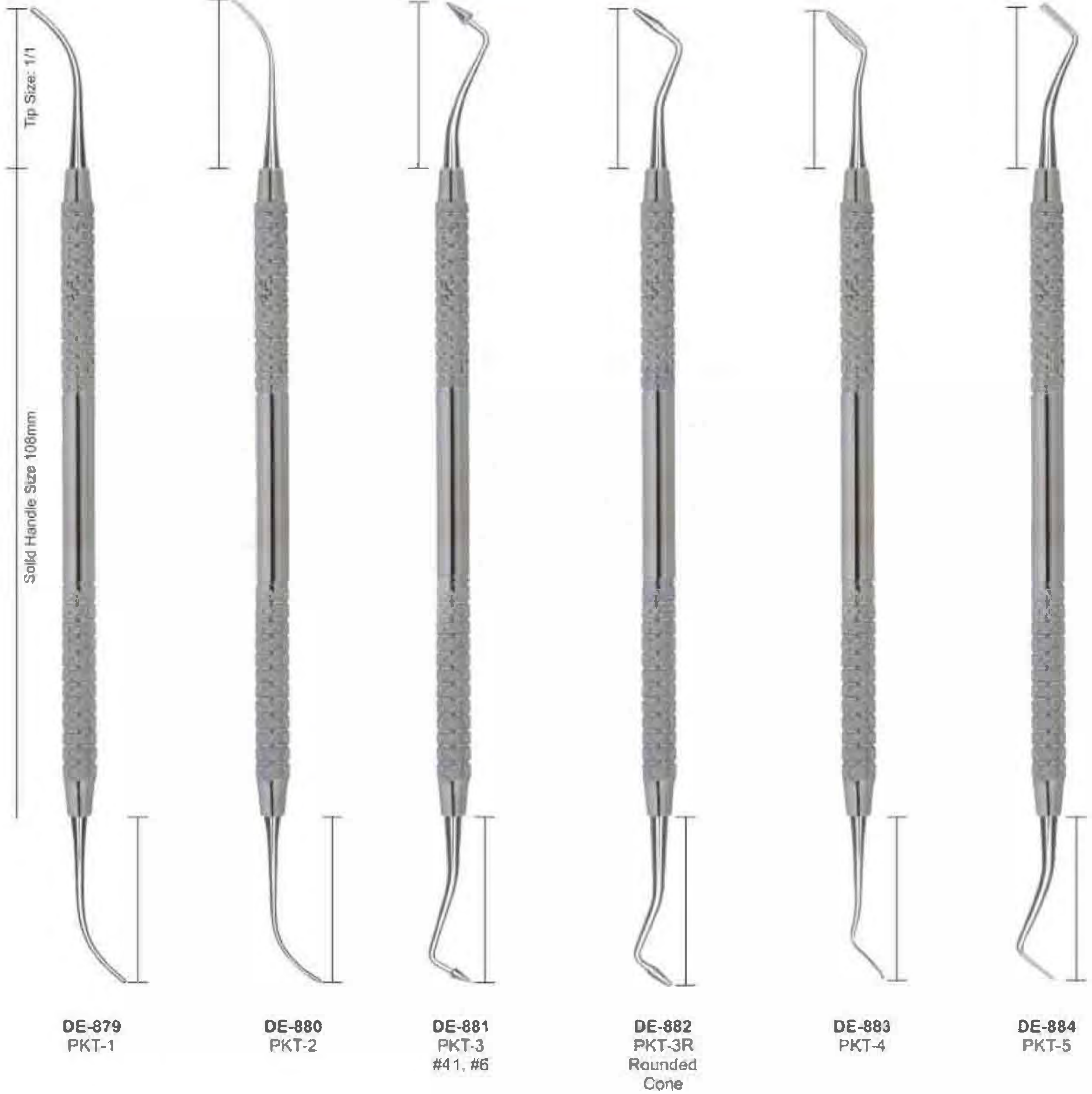

FILLING INSTRUMENTS

- Инструменты для реставрации
 - Instruments pour plombage
 - Füllungsinstrumente (mit Kontrawinkel)
- Інструменти для реставрації
 - Instrumentos para obturaciones
 - ملء انسكوك

CHISELS

HOES



- Шпатель для цемента
- Spatules à ciment
- Zementspatel

- Шпатель для цемента
- Espátulas para cemento
- ملاط الاسمنت



DE-893 00	DE-894 0	DE-895 1	DE-896 2	DE-897 3	DE-898 4	DE-899 3 Weston	DE-900 1 medium cement	DE-901 1				
DE-902 Le Cron	DE-903 Le Cron	DE-904 Le Cron	DE-905 MSY	DE-906 MSY	DE-907 Le Cron	DE-908 Hylin	DE-909 Hylin	DE-910 Hylin	DE-911 Zahle	DE-912 Zahle	DE-913 Zahle	DE-914 Gritman

WAX KNIVES

- Ножи для воска
- Couteaux à cire
- Wachsmeesser
- нож для воску
- Cuchillos para cera
- السكين الشمع

ALGINATE, PLASTER SPATULAS, WAX KNIVES PLASTER FOR KNIVES & PLASTER SHEAR



DE-915
Wooden Handle
Fig. 5
21.5 cm



DE-916
Wooden Handle
Fig. 7
19.5 cm curved



DE-917
Wooden Handle
Fig. 8
20 cm curved



DE-918
Wooden Handle
Fig. 9
22.5 cm curved



DE-919
Hook Knives



DE-920
Fig. 1
Lessmann
12.5 cm



DE-921
Fig. 2
Lessmann
17 cm



DE-922
Fig. 1
with small spoon
12.5 cm



DE-923
Fig. 2
with large spoon
17 cm



DE-924
Bacolite Handle
Wax Knives,
Small



DE-925
Bacolite Handle
Wax Knives,
Large



DE-926
Wooden Handle
Wax Knives,
Small



DE-927
Wooden Handle
Wax Knives,
Large



DE-928
Plaster Knife



DE-929
Fig. 1
17 cm



DE-930
Fig. 3
16 cm



DE-931
Fig. 4
16 cm



DE-932
Special Inox
19.5 cm



- Артикуляторы
- Articular
- Artikulations

- Артикулятори
- Articuler
- ارتیکولاتورس



DE-933

Technical Datas:

Intercondylar distance	120 mm.
condylar inclination	fixed at 30°
Bennet angle	fixed at 7°
Incisal table inclination	10°
Distance between mounting plates	85 mm.
Weight	400 gr.
Opening (item 5000)	125°
Opening (item 5010)	180°



DE-934

Technical Datas:

Intercondylar distance	110 mm.
condylar inclination	fixed at 30°
Bennet angle	fixed at 7°
Incisal table inclination	flat
Distance between mounting plates	85 mm.
Weight	450 gr.
Opening	180°



DE-935

Stainless Steel Finishing
DE-936
Royal Blue



DE-937



DE-938



DE-939



DE-940



DE-941



DE-942



DE-943



DE-944



DE-945



DE-946
Nakawani
Dental Laboratory
Instrument

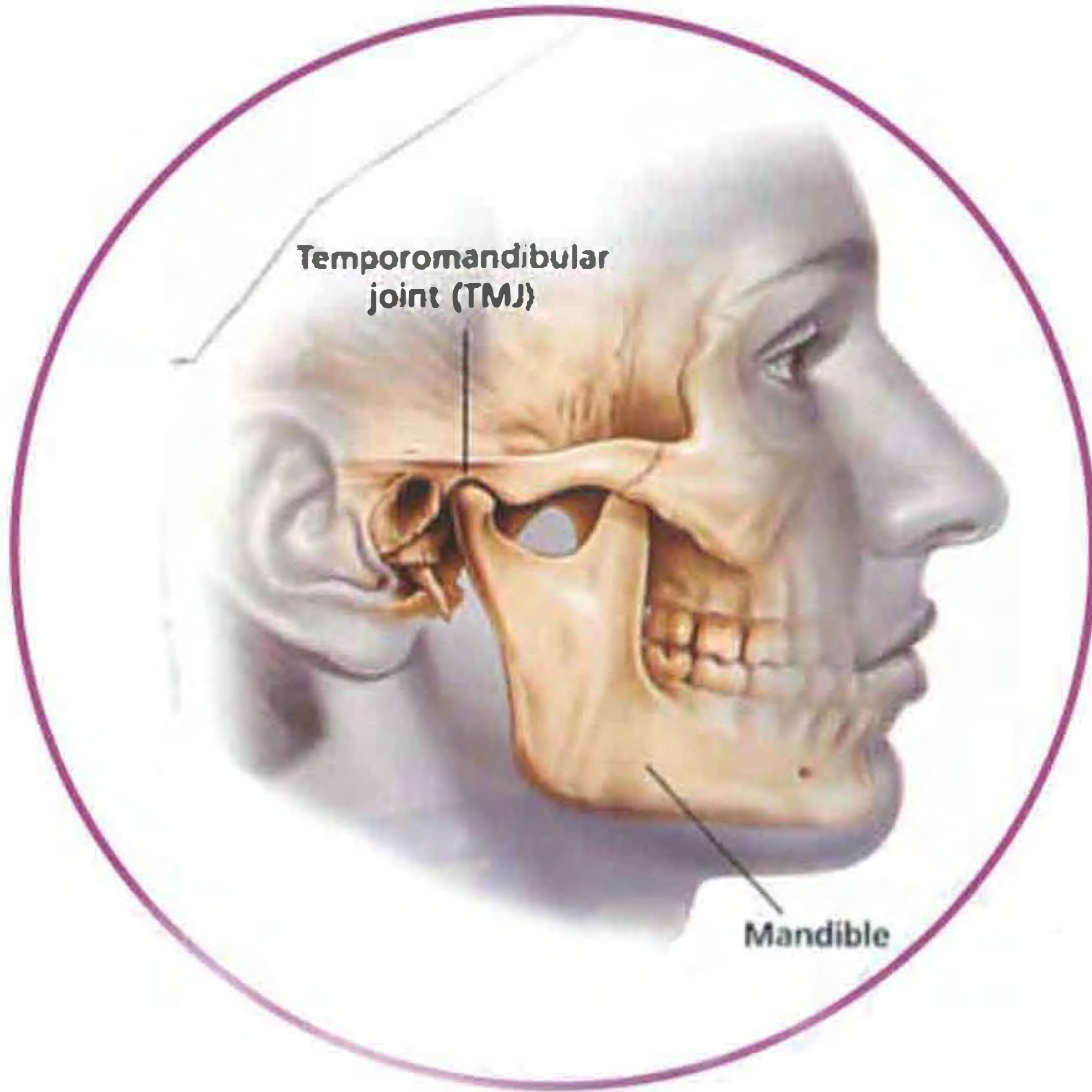

- Роторасширители
- Escarteurs - Ouvre-bouches
- Vestibulumabhalter / Mundspanner
- Роторозширювачі
- Separadores - Abre-bocas
- لكاشحات الفك واللسان



DE-947
Mouth Gag Molt
11 cm for (Children)



DE-948
Mouth Gag Molt
14 cm for (Adults)



Cheek Retractor
DE-949 140 mm
DE-950 180 mm



Cheek Retractor
DE-951 140 mm



DE-952
Wangen Holder,
vestibule
15 cm, with or without
lip protection,



DE-953
Wangen Holder,
vestibule 15 cm, with
or without lip protection,



DE-954
Wangen Holder
Wangen holder with dual
function, 17 cm,



DE-955
140 mm

DE-956
150 mm

Cheek Retractor

RETRACTORS - MOUTH GAGS

- Роторасширители
- Escarieurs - Ouvre-bouches
- Vestibulumabhalter / Mundspanner
- Роторозширювачи
- Separadores - Abre-bocas
- الكاشطون المصنوع الفم



DE-957
Fig. 1
weitlaner
10.5cm
13.5cm



DE-958
Fig. 2
weitlaner
10.5cm
13.5cm



DE-959
Stainless Steel
Double
Ended Cheek
Retractors



DE-960
Stainless Steel
Single
Ended Cheek
Retractors



DE-961 Weitlander 11cm
DE-962 13cm
DE-963 15cm



DE-964 Jennings 11cm
DE-965 13cm
DE-966 15cm



DE-967
Denhard
12 cm



DE-968
Roser-König
16 cm



DE-969
Roser-König
19 cm

INCHES
0 1 2 3 4 5 6 7 8 9

Wound, Bendable
Retractor, individually or as saving kit!

- Раноразширители
- Escarteuts
- Wundhaken

- Ранорозширювачі
- Seragabotes
- الكاشطات



DE-970
Cheek Retractor
Long



DE-971
Cheek Retractor
Long



DE-972
Cheek Retractor
Long



**Retractor with
Ergo Grip
DE-973** 24 cm,
ergonomic handle



DE-974
Cheek Retractors,
Retractor Ivory
Width adjustable
& fixable, 20 cm,



**Cheek Retractors,
tongue depressors
DE-975** 19 cm



**Cheek Retractors,
Minnesota
DE-976** 16 cm



**Cheek Retractors,
DE-977** 20 cm
easy to bend
by hand,



**Cheek Retractors,
retractor and tongue
pushers BISHOP with
comfortable margin,
DE-978** 16 cm,



**Retractors Cheek
retractor combination
Combination,
DE-979** 25 cm,

RETRACTORS

- Ранорасширители
- Escarteurs
- Wundhaken
- Ранорозширювачі
- Separadores
- الكاشحات



DE-982
Retractors, Unique
Length 175 mm,
angled 45°



DE-983
Retractors, Unique
Length 175 mm,
angled 90°



DE-984
Retractors
16cm



DE-985
Retractors
19cm



DE-986
Retractors, Mini-Langenbeck
16 cm, hooks 22 mm,



DE-987
Retractors, Cheek
retractors combination
21 cm, 2



DE-988
Mini Retractor
about 8 cm,



DE-989
Retractors
17 cm, hooks 22 mm



- Ранорасширители
- Escarteurs
- Wundhaken
- Ранорозширювачі
- Separadores
- الكاشطات



DE-990
Retractors, surgical-flat
surgically-flat, 21 cm, hook
30x16 mm,



DE-991
Retractors, surgical-flat
surgically-flat, 21 cm, hook
42x11 mm



DE-992
Retractors, surgical-flat
surgically-flat, 21 cm, hook
63x12 mm,



Retractors, surgical-flat
surgically-flat, 21 cm, hook
DE-993 30x16 mm,
DE-994 42x11 mm
DE-995 63x12 mm,



Retractors, Langenbeck
21 cm, hook
DE-996 30x11 mm
DE-997 30x16 mm,



DE-998
Retractors
21 cm,



DE-999
Farabeuf
(120 X 12mm
Set of 2 pieces)



DE-1000
Retractor Seldin



DE-1001
FELDMAN
RETRACTOR
5-1/2", 14cm



GUM SCISSORS

- Ножницы десневые
- Ciseaux à gencives
- Zahnfleischscheren
- Ножиці для ясен
- Tijelas para encías
- مقص صمغ



DE-1002
Iris
115mm
Straight



DE-1003
Iris
115mm
Curved



DE-1004
Goldman-Fox
130mm
Saw edge, straight



DE-1005
Goldman-Fox
130mm
Saw edge, Curved



DE-1006
La Grange
115mm
Saw edge, double Curved



Mayo
DE-1007 140mm
DE-1008 170mm
DE-1009 230mm
Straight



Mayo
DE-1010 140mm
DE-1011 170mm
DE-1012 230mm
Curved



Metzenbaum
DE-1013 145mm
DE-1014 180mm
DE-1015 200mm
Straight



Metzenbaum
DE-1016 145mm
DE-1017 180mm
DE-1018 200mm
Curved



DE-1019
Kelly
160mm
Straight



DE-1020
Kelly
160mm
Curved



DE-1021
Iris
115mm
Straight



DE-1022
Iris
115mm
Curved



DE-1023
La Grange
115mm
Double Curved



DE-1024
Goldman-Fox
130mm, Straight



DE-1025
Goldman-Fox
130mm, Curved



DE-1026
Kelly
160mm, Curved



DE-1027
Iris
115mm, Straight



DE-1028
Iris
115mm, Curved



DE-1029
Micro Iris
90mm, Curved



• Ножницы десневые
• Ciseaux à gencives
• Zahnfleischscheren

• Ножницы для ясен
• Tijeras para encías
• منص صمغ



DE-1030
Iris
115mm
Angled



DE-1031
Iris
115mm
Curved



DE-1032
Goldman-Fox
130mm
Saw edge,
straight



DE-1033
Goldman-Fox
130mm
Saw edge,
curved



DE-1034
Goldman-Fox
130mm
Saw edge,
double curved



DE-1035
La Grange
115mm
Saw edge,
double curved



DE-1036
Neumann
120mm
Saw edge,
double curved



DE-1037
Kilner (Ragnell)
120mm
Straight



DE-1038
Kilner (Ragnell)
120mm
Curved



DE-1039
Joseph
140mm
Straight



DE-1040
Joseph
140mm
Curved



DE-1041
Kelly
160mm
Straight



DE-1042
Kelly
160mm
Curved



DE-1043
Locklin
160mm
Saw edge,
angular



DE-1044
Locklin
120mm
160mm
Saw edge,
angular



DE-1045
Dean
170mm
Saw edge,
angular



DE-1046
Spencer
90mm



DE-1047
Spencer
130mm



DE-1048
Spencer
115mm



DE-1049
Noyes
110mm, Straight



DE-1050
Noyes
110mm
Curved



DE-1051
Noyes
110mm
Angular



DE-1052
Castroviajo
150mm
Curved

NEEDLE HOLDERS

- Иглодержатели
- Porte-aiguilles
- Nadelhalter
- Голкотримачи
- Porta-agujas
- اصحاب ابرة



DE-1053
130mm
Straight



DE-1054 Mayo 130mm
DE-1055 Mayo 160mm
DE-1056 Mayo 180mm
Straight Curved



DE-1057 Mayo 140mm
DE-1058 Mayo 200mm
Straight Curved



DE-1059 Metzenbaum 145mm
DE-1060 Metzenbaum 200mm
Straight Curved



DE-1061 Beebee 110mm
Saw edge, straight



DE-1062 Beebee 110mm
Saw edge, curved



DE-1063 Beebee 110mm
Saw edge, straight



DE-1064 Beebee 110mm
Saw edge, curved

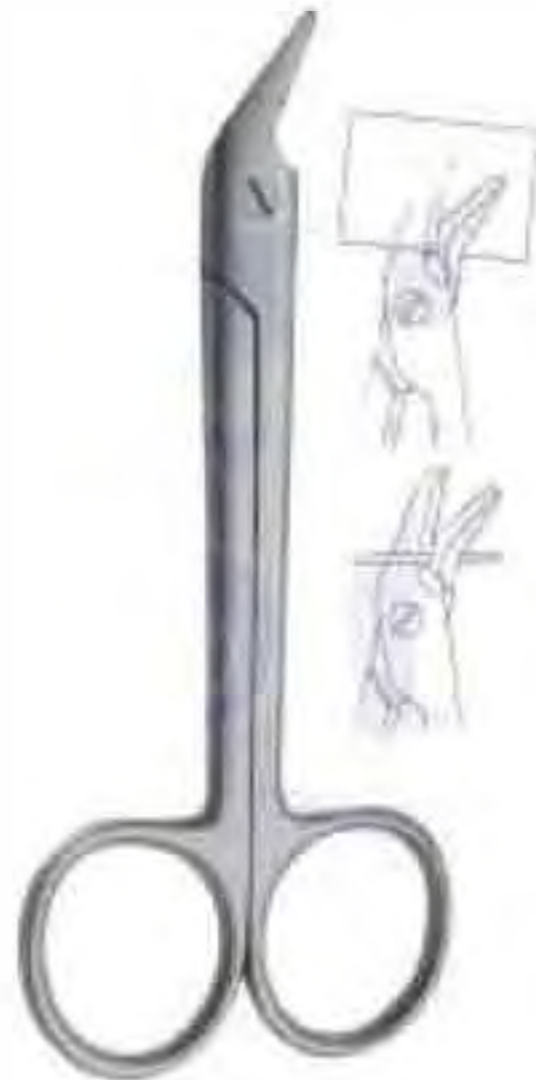

DE-1065 Universal 120mm
Saw edge



DE-1066 Universal 120mm



Crile
DE-1067 130mm
DE-1068 150mm
DE-1069 180mm



DE-1070 Halsey 130mm



DE-1071 Baumgartner 130mm



DE-1072 Derf 120mm



DE-1073 Delicate 150mm



Mayo-Hegar
DE-1074 130mm
DE-1075 160mm
DE-1076 180mm
DE-1077 200mm



DE-1078 Crile-Wood 150mm
straight



DE-1079 Crile-Wood 150mm
curved

INCHES

• Иглодержатели
• Porte-aiguilles
• Nadelhalter

• Голкотримачи
• Porta-agujas
• إبرة



Castroviejo
DE-1080 130mm
DE-1081 150mm
DE-1082 180mm



DE-1083
Halsey
130mm



DE-1084
Baumgartner
130mm



DE-1085
Derf
120mm



DE-1086
Delicate
150mm



DE-1087
Adson
170mm



Mayo-Hegar
DE-1088 130mm
DE-1089 160mm
DE-1090 180mm
DE-1091 200mm



DE-1092
Crile-Wood
150mm



Castroviejo
DE-1093 str 140mm cvd
DE-1094 str 180mm cvd



Olsen-Hegar Needle Holder With Scissors
DE-1095 140mm



Gillies Needle Holder With Scissors
DE-1096 160mm



Mathieu
DE-1097 140mm
DE-1098 170mm



Castroviejo
DE-1099 str 140mm cvd
DE-1100 str 180mm cvd



Olsen-Hegar Needle Holder With Scissors
DE-1101 140mm



Gillies Needle Holder With Scissors
DE-1102 160mm

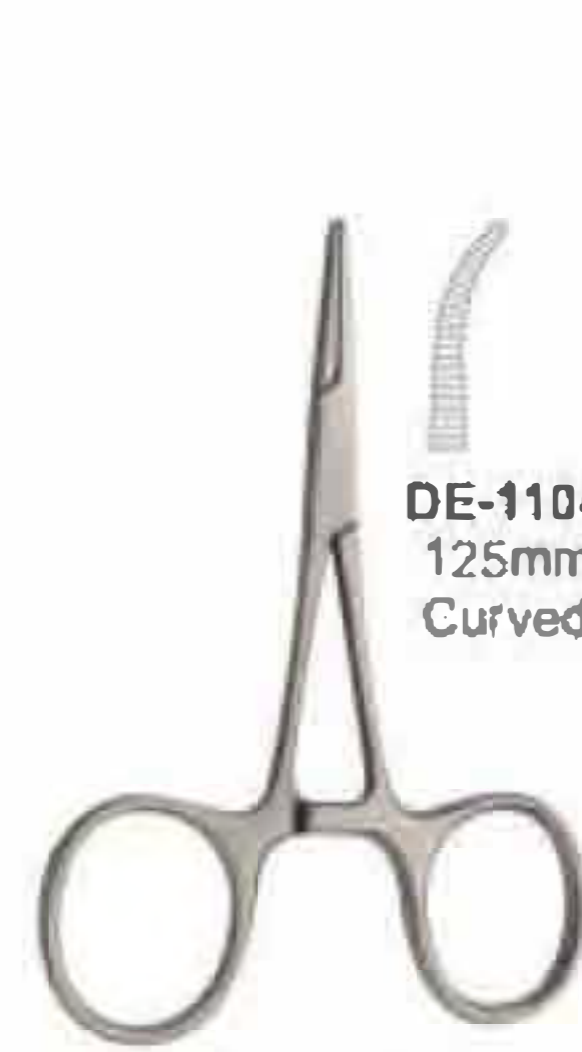

Hartmann (Baby Mosquito)
DE-1103 90mm straight



Halstead Mosquito
DE-1105 125mm
Straight

DE-1104
125mm
Curved

DE-1106
Curved

HAEMOSTATIC FORCEPS & TOWEL CLAMPS

- Зажимы артериальные, зажимы для салфеток
- Pincers hemostaticas, Pincers a compresas
- Arterienklemmen, Tuuchklemmen
- Затискачі артеріальні, затискачі для серветок
- Pinças hemostáticas, Pinças para compresas
- المنطق هييموستاتيكية المنسوجة

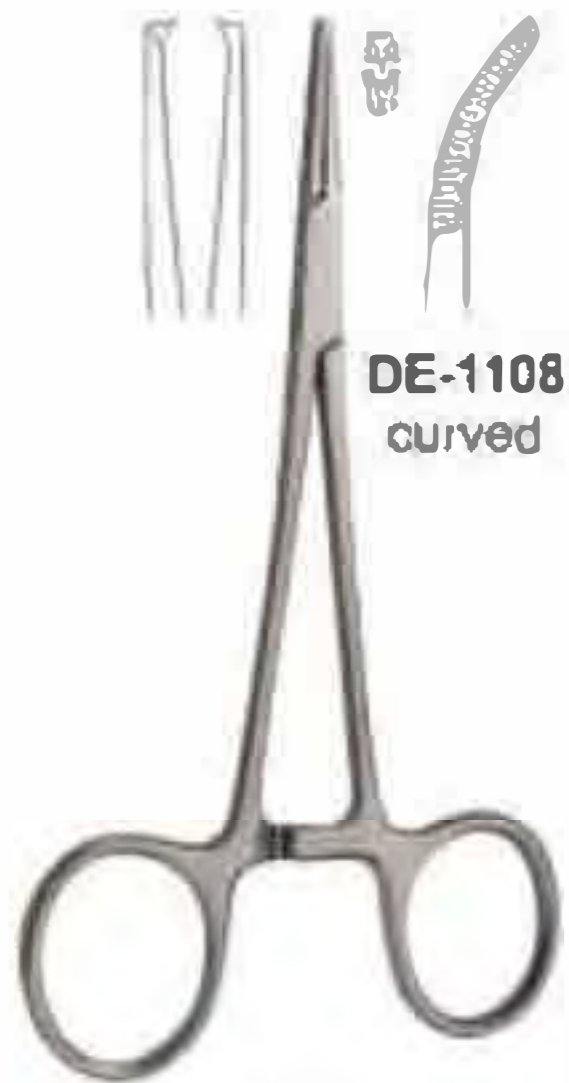

DE-1108
curved

Haistead Mosquito 1x2
DE-1107 125mm
straight



DE-1110
curved

Kelly
DE-1109 140mm
straight

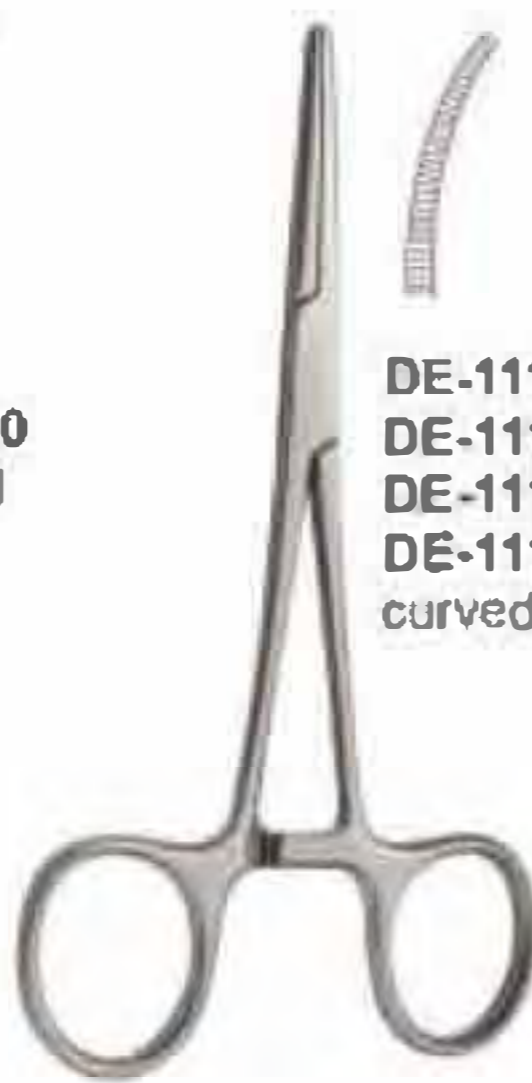

DE-1115 140mm
DE-1116 160mm
DE-1117 180mm
DE-1118 200mm
curved

Rochester-Pean
DE-1111 140mm
DE-1112 160mm
DE-1113 180mm
DE-1114 200mm
straight

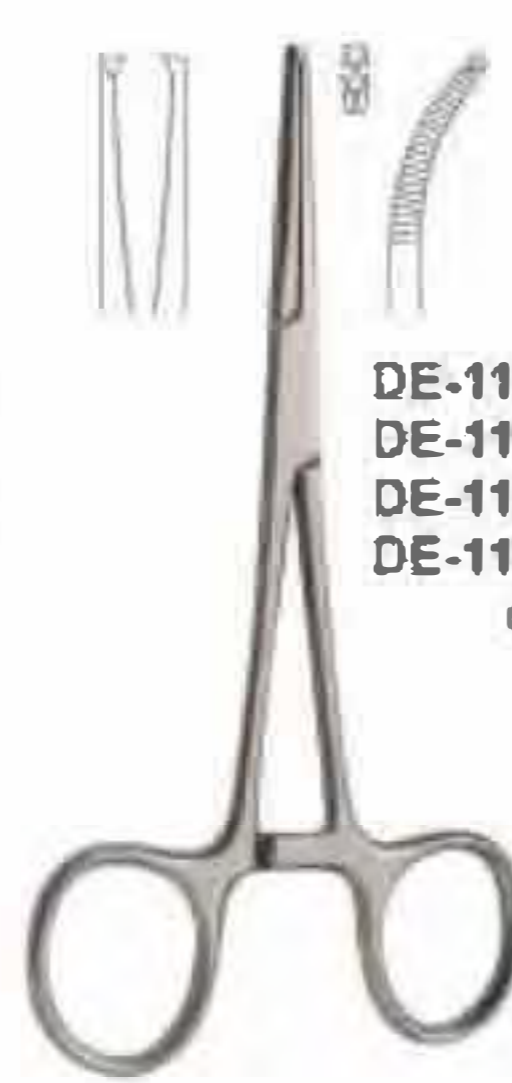

DE-1123 140mm
DE-1124 160mm
DE-1125 180mm
DE-1126 200mm
curved

Rochester-Kocher 1x2
DE-1119 140mm
DE-1120 160mm
DE-1121 180mm
DE-1122 200mm
straight



DE-1128
curved

DE-1127
Kelly-Rankin
160mm
straight



Lorna
DE-1129 100mm
DE-1130 130mm



DE-1131
Allis-Baby 3:4
150mm



DE-1132
Allis 4:5
200mm



DE-1133
Allis 6:7
200mm



Backhaus
DE-1134 140mm
Not-perforating and
not-damaging



DE-1135
Backhaus
130mm



DE-1136
Backhaus
85mm



DE-1137
Jones
90mm



DE-1139
curved

Gross Maier
Dressing Forceps
DE-1138 200mm straight



Foerster
Dressing Forceps
DE-1140 200mm



Spare rubber

Young
Tongue Forceps
DE-1141 170mm



Collins
Tongue Forceps
DE-1142 170mm

RUBBER DAM CLAMPS FORCEPS

- Инструменты для системы коффердам
- Pinces porte-clampons a dique
- Koferdam Klammerzangen

- Инструменты для системы коффердам
- Pinzas de engrapar para dique de caucho
- السد المطاط الملقط المشابك



DE-1143

On request the Content of the rubber dam kit can be changed with other instruments.

Content:

- | | | | |
|----|---------------------------|----|---------------------------|
| 01 | Anisworth | 08 | Rubber Dam Clamp Fig. 212 |
| 02 | Brewer | 09 | Rubber Dam Clamp Fig. 211 |
| 03 | Clamps Stand | 10 | Rubber Dam Clamp Fig. 8 |
| 04 | Denture Plate | 11 | Rubber Dam Clamp Fig. 8A |
| 05 | Rubber Dam Frame | 12 | Rubber Dam Clamp Fig. 14 |
| 06 | Rubber Dam Box Lower Case | 13 | Rubber Dam Clamp Fig. 14A |
| 07 | Rubber Dam Box Upper Case | 14 | Rubber Dam Clamp Fig. 0 |
| | | 15 | Rubber Dam Clamp Fig. 00 |
| | | 16 | Rubber Dam Clamp Fig. 2 |
| | | 17 | Rubber Dam Clamp Fig. 2A |
| | | 18 | Rubber Dam Clamp Fig. 7 |



DE-1144
Anisworth



DE-1145
Brewer



DE-1146
Ivory light weight



DE-1147
Palmer



DE-1148
Separating
Elastic
Plier



RUBBER DAM CLAMPS

- Кламмера для коффердама
- Стампы для ди́ге
- Kofferdam Klammern
- Кламмера для коффордама
- Grapas para dique de caucho
- للمصنوع من المطاط



DE-1149
Fig. 15



DE-1150
Fig. 18



DE-1151
Fig. 24



DE-1152
Fig. 25



DE-1153
Fig. 26



DE-1154
Fig. 28



DE-1155
Fig. 30



DE-1156
Fig. 31



DE-1157
Fig. 51



DE-1158
Fig. 138



DE-1159
Fig. 139



DE-1160
Fig. 200



DE-1161
Fig. 201



DE-1162
Fig. 202



DE-1163
Fig. 203



DE-1164
Fig. 204



DE-1165
Fig. 205



DE-1166
Fig. 3



DE-1167
Fig. W3



DE-1168
Fig. 4



DE-1169
Fig. 56A



DE-1170
Fig. 7



DE-1171
Fig. 7A



DE-1172
Fig. 8



DE-1173
Fig. 8A



DE-1174
Fig. W8A



DE-1175
Fig. 10



DE-1176
Fig. 11



DE-1177
Fig. 12A



DE-1178
Fig. 13A



DE-1179
Fig. 14



DE-1180
Fig. 14A



DE-1181
Fig. 14AN



DE-1182
Fig. 22



DE-1183
Fig. 27



DE-1184
Fig. 207



DE-1185
Fig. 29



DE-1186
Fig. 206



DE-1187
Fig. 208



DE-1188
Fig. 209



DE-1189
Fig. 1



DE-1190
Fig. 1A



DE-1191
Fig. 2



DE-1192
Fig. 2A



DE-1193
Fig. W2A



DE-1194
Fig. 0



DE-1195
Fig. 00



DE-1196
Fig. 210



DE-1197
Fig. 211



DE-1198
Fig. 212



DE-1199
Fig. 6



DE-1200
Fig. 9



DE-1201
Fig. N06



DE-1202
Fig. U67



DE-1203
Fig. 214



DE-1204
Fig. P1



DE-1205
Fig. P2



DE-1206
Fig. G-1



DE-1207
Fig. G-2

INCHES
0 1 2 3 4 5 6 7 8 9

- Инструменты для удаления коронок
- Arrache-couronnes
- Teleskopkronenzangen

- Инструменты для выдавливания коронок
- Алгачса-согона
- مزيلات للتاج



DE-1210
Crown Spreaders



DE-1211
Mershon
14 cm
Band Pusher



DE-1212
Fig. 0



DE-1213
Manual Crown Remover



DE-1214
Complete with 3 tips
and tightening keys

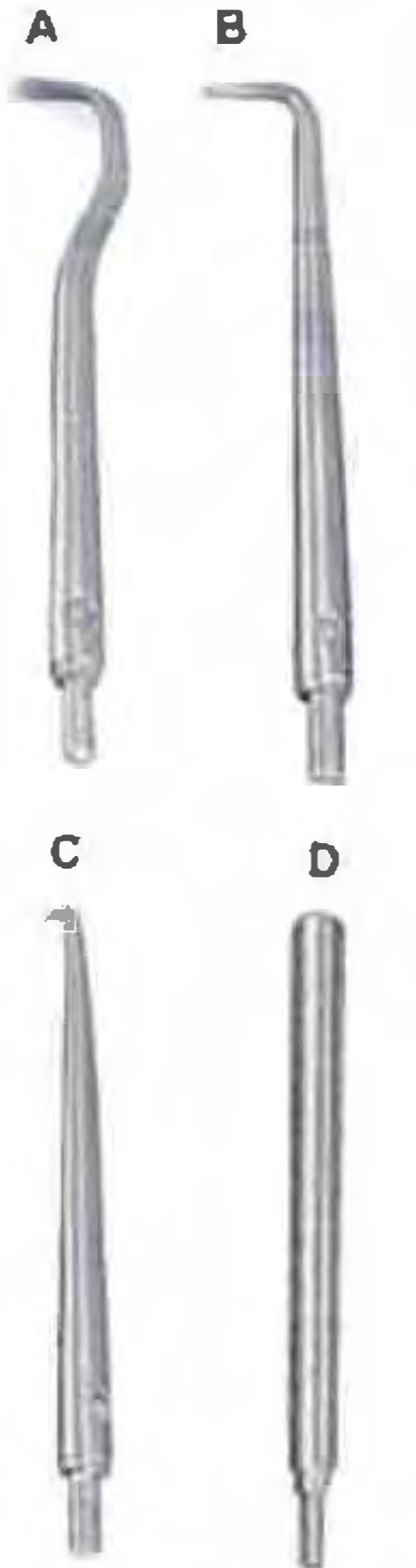

semi-automatic crown
& bridge remover



DE-1215



DE-1216
Manual Crown Remover

MATRIX RETAINERS

- Матрицодержатели
- Porte Matrices
- Matrizenspanner

- Матрицотримувачи
- Porta Matrices
- مصفوفة الخدم



DE-1217
Fig. 5
Ivory 8
5 cm



DE-1218
Fig. 6
Ivory 8
8 cm



DE-1219
Fig. 7
Ivory 8
7 cm



DE-1220
Fig. 1
Tofflemire-Universal



DE-1221
Fig. 2
Tofflemire-Junior



DE-1222
Fig. 3
Tofflemire-Senior



DE-1223
Narrow



DE-1224
Wide

Siqveland Retainers

Amalgam Well



DE-1225
Stainless Steel
Amalgam Well



DE-1226
Ivory 12



DE-1227
Ivory 1



DE-1228
Ivory



DE-1229
Elliot

INCHES
0 1 2 3 4 5 6 7 8 9

AMALGAM INSTRUMENTS & SCALPEL HANDLES

• Инструменты для амальгамы
• Instruments pour amalgame
• Amalgamisinstrumente

• Инструменты для амальгами
• Instrumentos para amalgama
• المسكوك للملغم

• Ручки для скальпелей
• Manches de bistouris
• Skalpellgriffe

• Ручки для скальпелю
• Mangos de bisturi
• مشرط بلانض



DE-1230
Fig. 10
165mm
English pattern



DE-1231
Fig. 1
185mm
German pattern



DE-1232
Fig. 1
150mm
Swiss pattern



DE-1233
Fig. 1
150mm



DE-1234
Fig. 2
150mm, 45°



DE-1235
Fig. 3
140mm, 90°



DE-1236
Fig. 3
5" (12.7cm)



DE-1237
Fig. 3G
5" (12.7cm)



DE-1238
Fig. 4
5 1/2" (13.7cm)



DE-1239
6 Way Adjustable Angled Scalpel Handle

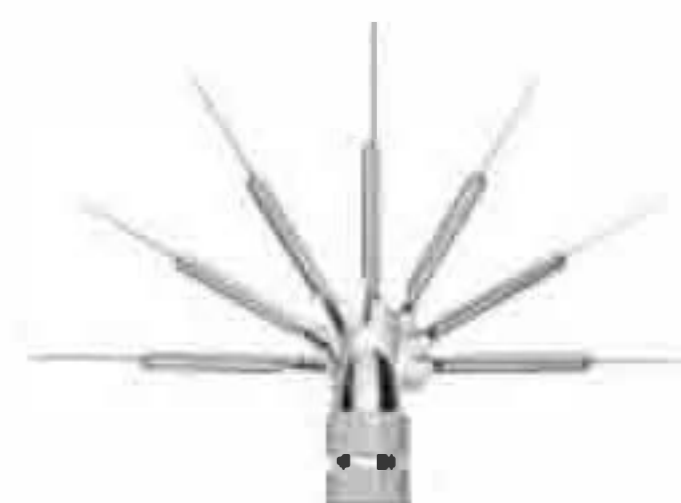

Locks At 90°, 60°, 30°,
Straight, 120°, 150°, 180°,
Angles

AMALGAM INSTRUMENTS

- Инструменты для амальгамы
- Instruments pour amalgame
- Amalgam-Instrumente
- Инструменти для амальгамы
- Instrumentos para amalgama
- لصوك للملم

AMALGAM CARRIERS



DE-1240
Distal
Improves visibility and access to posterior regions.

DE-1241
Single-End

DE-1242
Double-End

TIP SIZES FOR DOUBLE-END



2.0 mm
DE-1243
Mini/
Regular

2.0 mm
DE-1244
Large/
Regular

2.0 mm
DE-1245
Jumbo/
Regular

TIP SIZES FOR DISTAL OR SINGLE-END



1.5 mm
DE-1246
Mini/
Single-End

2.0 mm
DE-1247
Regular
Single-End

2.8 mm
DE-1248
Large
Single-End



1.5 mm
DE-1249
Mini
Distal

2.0 mm
DE-1250
Regular
Distal



DE-1251
Amalgam
Well

ROOT PLANNING FILES



DE-1252
Kramer-Nevins
Bone Chisel



DE-1253
Kramer-Nevins
Bone Chisel



DE-1254
Molt 18.5cm
Auto Clavable
Plastic Tips.



DE-1255
Mead 18.5cm
Non Auto Clavable
Plastic Tips.



DE-1256
Miller



DE-1257
Miller

BONE FILES



DE-1258
Miller 21



DE-1259
Miller 1X
cross cut



DE-1260
Miller 2X
cross cut



DE-1261
Miller 52



DE-1262
Wahl 1



PERIODONTAL INSTRUMENTS

- Инструменты пародонтологические
- Instruments pour la parodontologie
- Instrumente für die Parodontologie
- Инструменти пародонтологични
- Instrumentos para periodoncia
- الصدك هتة

PERIOSTEEL ELEVATORS



DE-1263 BUSER DE-1264 Ohi 10 DE-1265 Howard 9H DE-1266 Freer DE-1267 Freer 15 DE-1268 Freer 16 DE-1269 Molt 9 DE-1270 Allen 9A DE-1271 Prichard 3



DE-1272 Seldin 23 DE-1273 Goldman-Fox 14 DE-1274 P 24G DE-1275 Raspator, Raspatory Length 175 mm, 10.0mm DE-127A Raspator, Raspatory Length 175 mm, 6.4mm DE-127B Raspator, Raspatory Length 175 mm, 3.0mm DE-1276 Raspator, Williger Length 170 mm, different widths (4 mm, 5 mm or 7 mm), 4.0mm DE-1276A Raspator, Williger Length 170 mm, different widths (4 mm, 5 mm or 7 mm), 5.0mm DE-1276B Raspator, Williger Length 170 mm, different widths (4 mm, 5 mm or 7 mm), 7.0mm





Behind Every Smile is a Story

• QUALITY - ЯКІСТЬ • PRECISION - ТОЧНІСТЬ • ACCURACY - ПРАВИЛЬНІСТЬ • DURABILITY - ЗНОСОСТІЙКІСТЬ

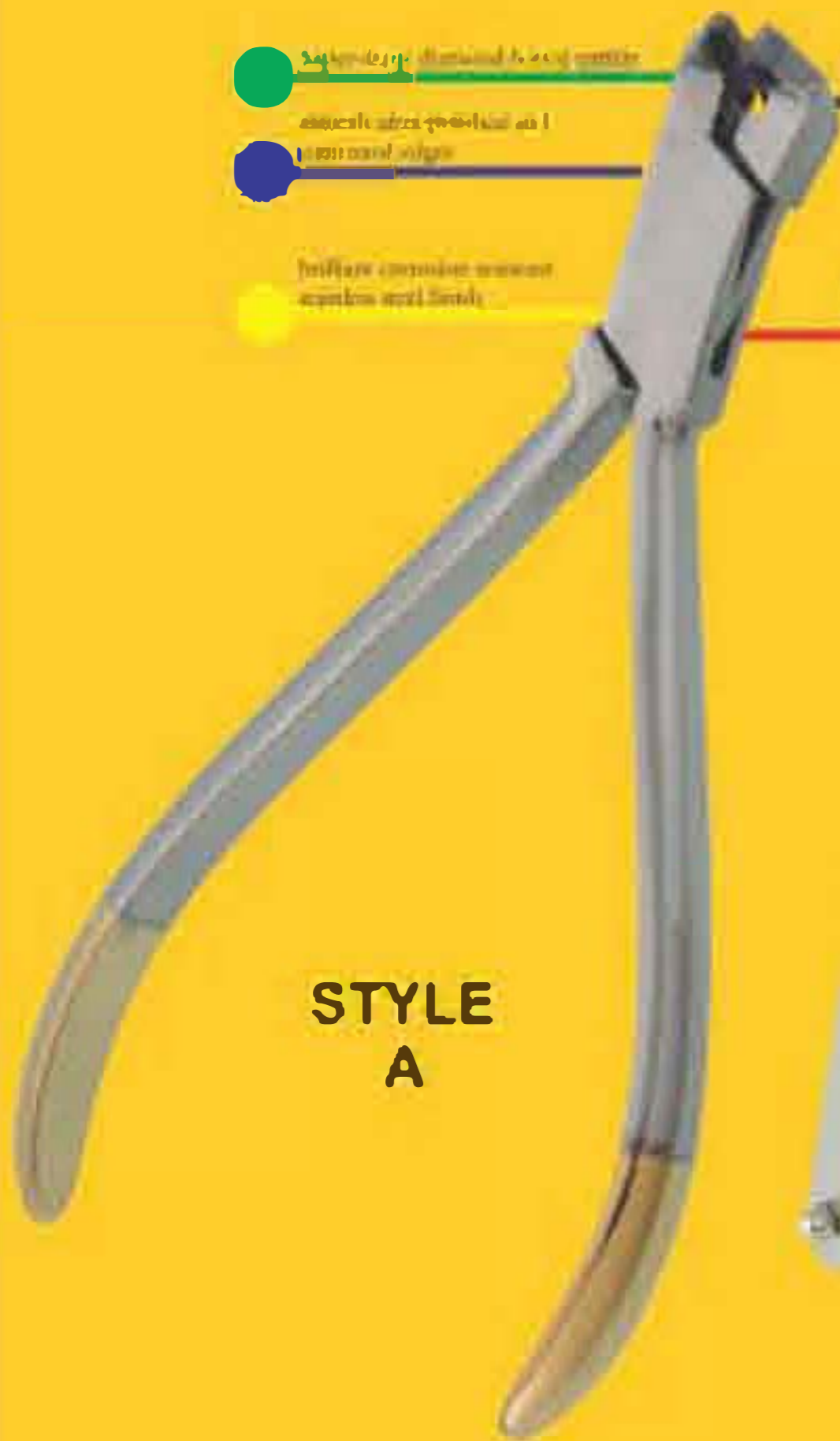

• Made of high quality stainless steel
• Precision ground bevels on the working ends
• Ergonomic design for comfort and control
• Polished finish for hygiene and durability

• Made of high quality stainless steel
• Precision ground bevels on the working ends
• Ergonomic design for comfort and control
• Polished finish for hygiene and durability



• Made of high quality stainless steel
• Precision ground bevels on the working ends
• Ergonomic design for comfort and control
• Polished finish for hygiene and durability



ORTHODONTIC INSTRUMENTS

- Инструменты ортодонтические
- Instrumentos Ortodonticos
- Orthodontische Instrumente
- Инструменти ортодонтични
- Instruments Orthodontiques
- ادوات تقويم الأسنان



DE-1277
Aluminum Height
Gauge 0.22



DE-1278
Aluminum Height
Gauge 0.18



DE-1279
Bone Bracket Gauge



DE-1280
Bone Thickness Gauge
40mm, 180mm



DE-1281 OSTEOMETER
Measuring Forceps For Jaw
Ridge Width measurement, scale
on both sides. rustfree, autoclavie



DE-1282
Direct bonding
bracket holders,
135mm



DE-1283
Deluxe Bracket
Holder Tweezers



DE-1284
Direct bonding
bracket holders,
136mm



DE-1285
Direct Bond
Bracket Holder
Tweezers,
Small Tip



DE-1286
Direct bonding
bracket holders,
140mm



DE-1287
Direct bonding
bracket holders,
135mm



DE-1288
Direct Bonding
Bracket Holders,
140mm



- Инструменты ортодонтически
- Instrumentos Ortodonticos
- Orthodontische Instrumente
- Инструменти ортодонтички
- Instruments Orthodontiques
- أدوات تقويم الأسنان



DE-1289
Band seater auto cleavable



DE-1290
Ortho light scaler double ended



DE-1291
Ortho light scaler double ended



DE-1292
Ortho light scaler double ended



DE-1293
Twist-on elastic module instrument



DE-1294
Twist-on elastic module instrument



DE-1295
Schure Band Seater



DE-1296
Ortho light scaler

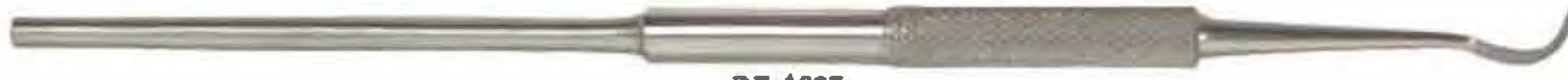

DE-1297
Ortho light scaler

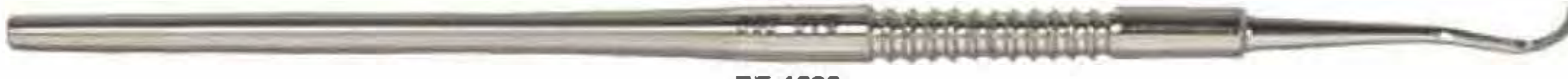

DE-1298
Ortho light scaler heavy



DE-1299
Ortho instrument



DE-1300
Ortho instrument



DE-1301
Ortho Light Band Pusher Scaler



ORTHODONTIC INSTRUMENTS

- Инструменты ортодонтические
- Instrumentos Ortodonticos
- Orthodontische Instrumente
- Инструменти ортодонтични
- Instruments Orthodontiques
- أدوات تقويم الأسنان

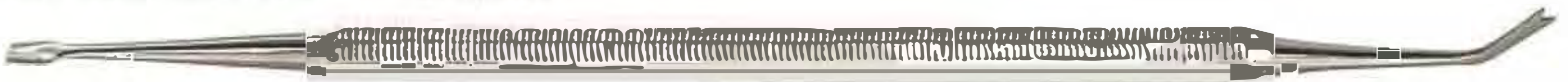

DE-1302
Ortho Light double ended
ligature director



DE-1303
Ortho Light double ended
ligature director scaler



DE-1304
Ortho Light double ended ligature scaler director
trivale coil spring are remove modules with one instruments



DE-1305
Ortho band pusher scaler



DE-1306
Ortho Light Band Pusher Scaler



DE-1307
Ortho ligature director single ended



DE-1308
Ortho Light double ended ligature
director scaler



DE-1309
Ortho Light double ended ligature scaler/director
trivale coil spring are remove modules with one instruments



DE-1310
Ortho Light double ended ligature director



DE-1311
Ortho Light Ligature Director Scaler

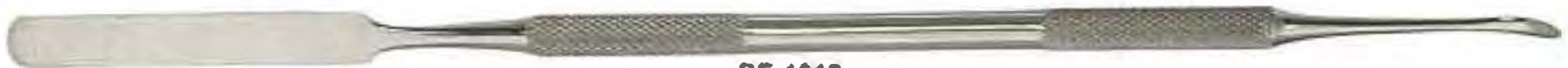

DE-1312
Ortho light ligature director double ended



DE-1313
Double ended cement spatula



DE-1314
Ortho light scaler single ended



- Щипцы для ортодонтии и протезирования
- Pincers pour l'orthodontie et la prothèse
- Zangen für Kieferorthopädie und Prothetik
- Щипцы для ортодонтии та протезування
- Alicates para ortodoncia y prótesis
- كملالة لفهم الأسنان برو-تيسوس

BOX JOINT PLIERS

DE-1315
Universal Dolphin Style
Wire Bending & cutting pliers



DE-1316 Band Removing Plier
The curved blade of the band removing plier can strip easily and gently remove directly to the tooth. Length 130mm



DE-1317
Tweed Loop forming Pliers



DE-1318
How Plier curved
Universally usable tool for the multiband technology for wires up to .028". Length 130mm



DE-1319 How Plier
Universally usable tool for the multiband technology for wires up to .028". Length 135mm



DE-1320
Nance Loop forming Pliers



DE-1321
Bracket Removing Plier curved
Bracket Removing Plier curved for easy removal of brackets in the posterior region. Length 130mm



DE-1322
Young Wire Bending & Loop Forming Pliers



DE-1323
Wire Banding & Loop Forming Pliers



DE-1324
Adams, small wire bending and loop forming Pliers



DE-1325
Bracket Removing Plier Round Box
Bracket removing plier for comfortable and quick removal of the brackets. Length 135mm



DE-1326
Weingart Plier medium
Weingart plier that are ideal due to their curved tip for setting sheets and is capable of bending the ends. Length 145mm



PLIERS FOR ORTHODONTICS & PROSTHETICS

- Щипцы для ортодонтии и протезирования
- Pincers pour l'orthodontie et la prothèse
- Zangen für Kieferorthopädie und Prothetik
- Щипці для ортодонції та протезування
- Alicates para ortodoncia y prótesis
- كمانة لتطویر الأسنان پروتھتیس

BOX JOINT PLIERS

DE-1327 Adams Plier Round Box

Adams pliers for bending wire arches and bends right angles for wires up to .022", .025 tip to beak. Length 125mm



DE-1333 Adams Plier

Adams pliers for bending wire arches and bends right angles for wires up to .022", .025 tip to beak. Length 125mm



DE-1328

Falcon Beak Contouring Pliers.



DE-1334

Tweed Loop Formin Pliers



DE-1329

wires up to 0.020" / 0.7mm.



DE-1335 Bird Beak Plier Standard

Bird Beak Wire bending plier without notches, which is suitable as a universal utility tool. Length 125mm



DE-1330

Johnson Contouring Pliers



DE-1336

Mini Ligature cutters



DE-1331 Aderer

Large wire bending and loop forming pliers



DE-1337 Small

Fluch-cut distal and cutting Pliers with safety hold fitted with un-breakable, corrosion resistant and durable stainless steel tips



DE-1332

Tweed / angle rectangular arch forming & Torquing pliers



DE-1338 Large

Fluch-cut distal and cutting Pliers with safety hold fitted with un-breakable, corrosion resistant and durable stainless steel tips



INCHES
0 1 2 3 4 5 6 7 8 9

- Щипцы для ортодонтии и протезирования
- Pincers pour l'orthodontie et la prothèse
- Zangen für Kieferorthopädie und Prothetik
- Щипцы для ортодонтии та протезування
- Alicates para ortodoncia y prótesis
- كمشة لفهم الأسنان بروستيزون

BOX JOINT PLIERS

DE-1339
Tweed / Angel
1.78mm (.070") wide tips arch
forming and torquing pliers



DE-1340
Tweed / Angel
1.78mm (.070") wide tips arch
forming and torquing pliers



DE-1341
Lingual / Palatal arch
forming pliers



DE-1342
Aderer
Facebow loop forming Pliers



DE-1343
Waldsavhs wire bending
and cutting pliers



DE-1344 Aderer Plier
For the manufacturing of appliances and
activation of wires for wires up to .030" .fine
lip and up to .036" mean tip.
Length 130mm



DE-1345
Contouring Plier



DE-1346
Bands & Crowns Plier
in order to skirt



DE-1347
Ligature Forming Pliers



DE-1348
for double back and triple back
bands in 0.30" / 0.76mm & 0.36"
/ 0.91mm lingual arch wires



DE-1349
Bird Beak Wire Bending
& cutting pliers



DE-1350
Weingart Plier medium
Weingart plier that are ideal due to
their curved tip for setting sheets and
is capable of bending the ends.
Length 145mm



PLIERS FOR ORTHODONTICS & PROSTHETICS

- Щипцы для ортодонтии и протезирования
- Pincers pour l'orthodontie et la prothèse
- Zangen für Kieferorthopädie und Prothetik
- Щипці для ортодонції та протезування
- Alicates para ortodoncia y prótesis
- كاشطة لتقويم الأسنان بروستيزيس

LAP JOINT PLIERS



DE-1351
Distal End Cutter
Regular with T.C.

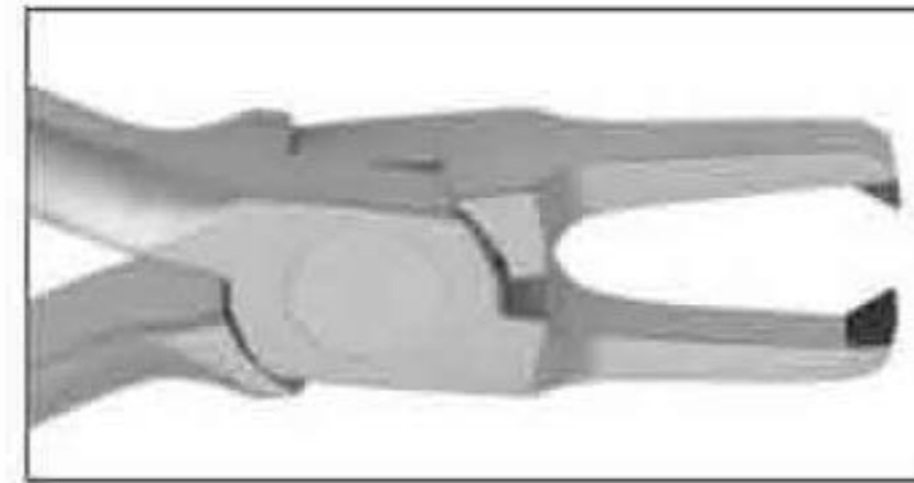

DE-1358
Bracket Remover Pliers
Straight With T.C.



DE-1352
Hard Wire Cutter With T.C.



DE-1359
Bird Beak Plier With TC.



DE-1353
Ligature Cutter Angled
15° With T.C.



DE-1360
Light Wire Bird Beak
Long Plier With TC.



DE-1354
Light Wire Cutter Micro
With T.C.



DE-1361
Adam Plier With TC.



DE-1355
Reversed Ligature
Cutter Angled
40° With T.C.



DE-1362
Tweed Arch Forming Plier
1.78mm With TC.



DE-1356
Posterior Band Remover Pliers
Long With T.C.



DE-1363
Weingart Plier Slim
With TC.

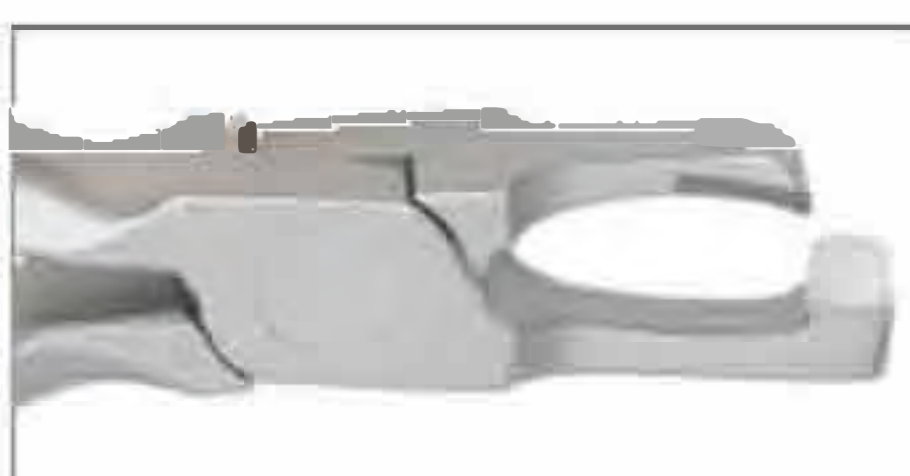

DE-1357
Posterior Band Remover Pliers
Medium With T.C.

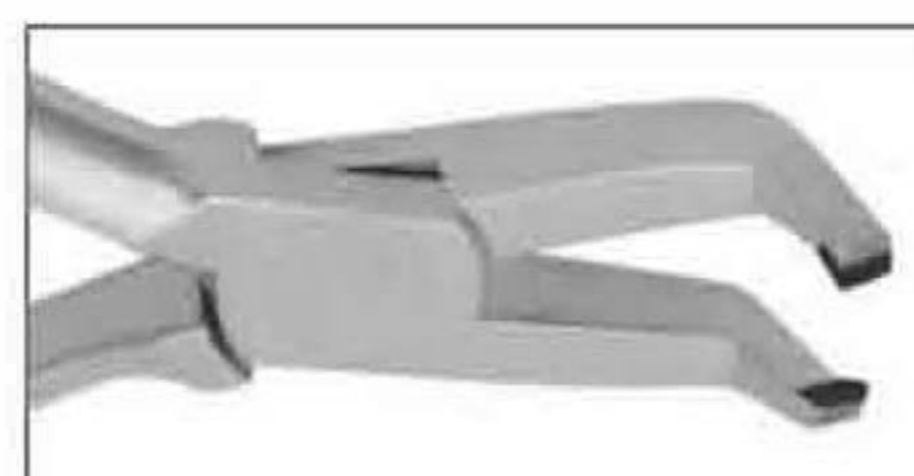

DE-1364
Bracket Remover Pliers
Angled With T.C.



INCHES
0 1 2 3 4 5 6 7 8 9

PLIERS FOR ORTHODONTICS & PROSTHETICS

- Щипцы для ортодонтии и протезирования
- Pincers pour l'orthodontie et la prothèse
- Zangen für Kieferorthopädie und Prothetik
- Щипцы для ортодонтии и протезирования
- Alicates para ortodoncia y prótesis
- أداة لفهم الأسنان برو-تيس

LAP JOINT PLIERS

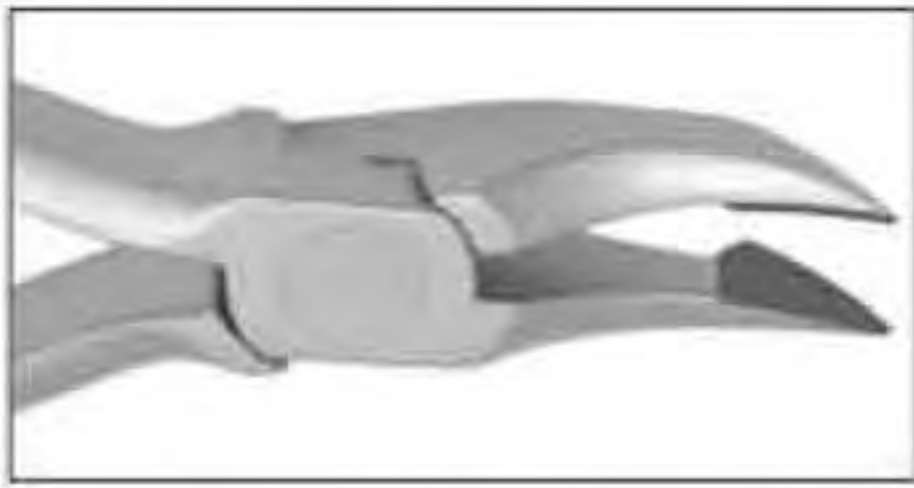

DE-1365
Weingart Plier Regular
With TC

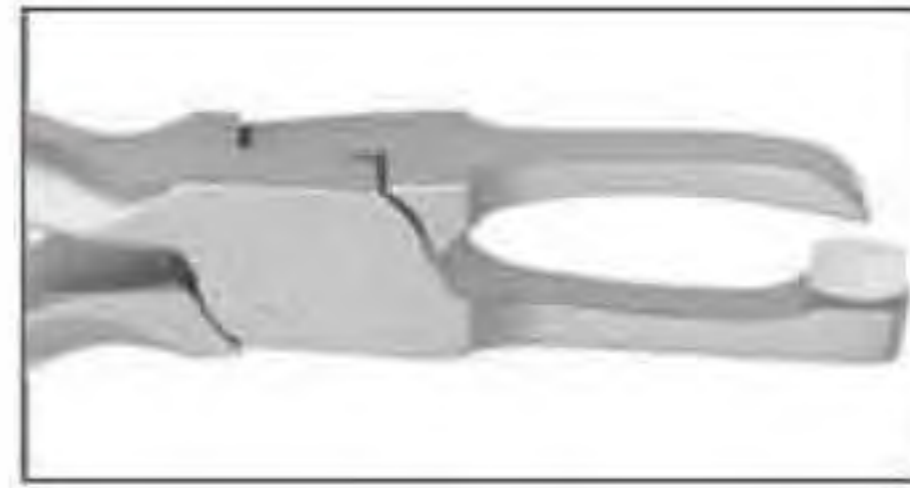

DE-1372
Posterior Bend Remover
Plier Long



DE-1366
Weingart General Utility Plier
Long Mouth With TC



DE-1373
Posterior Bend Remover
Plier Short

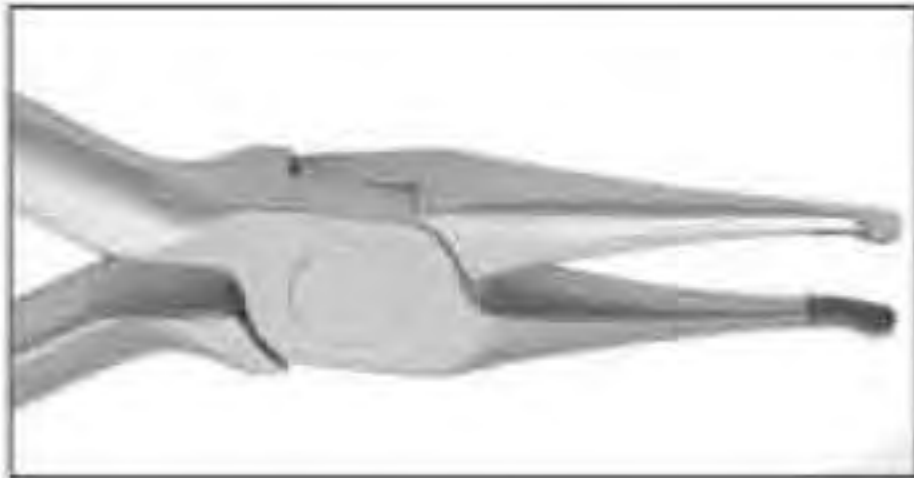

DE-1367
How Plier Straight
With TC



DE-1374
Posterior Bend Remover
Plier Medium

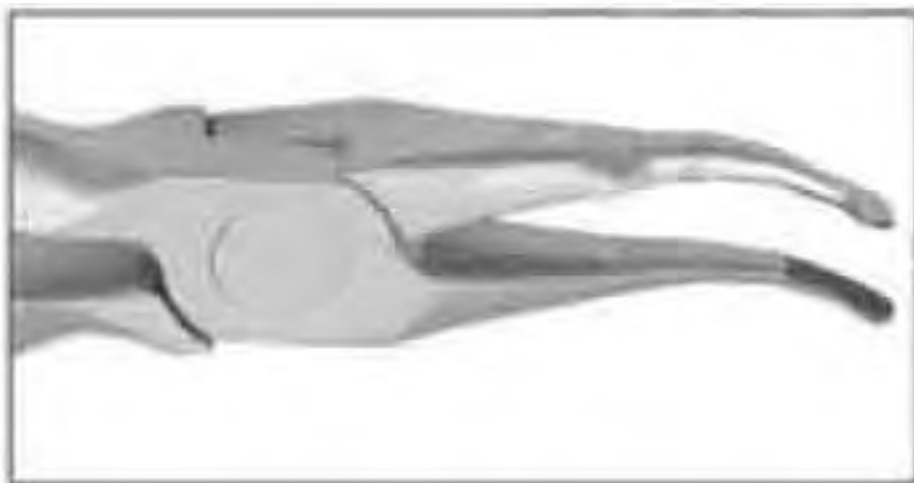

DE-1368
How Plier Curved
With TC



DE-1375
Bracket Remover Plier
Straight



DE-1369
Step Pliers with T.C
0.5mm

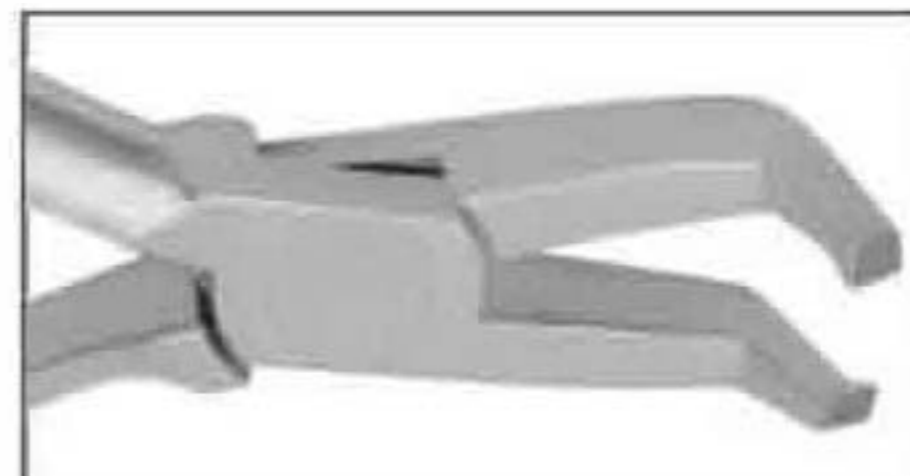

DE-1376
Bracket Remover
Angulated
Plier



DE-1370
Weingart Plier Utility
With TC

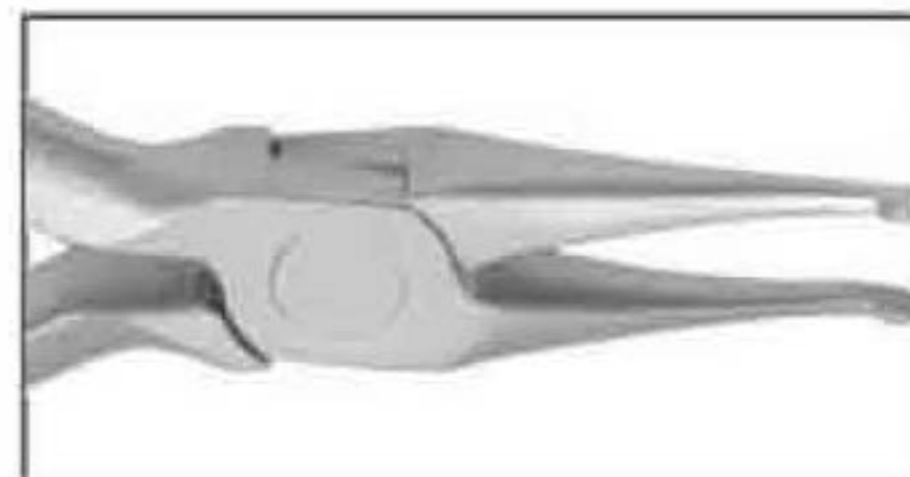

DE-1377
How Plier Straight



DE-1371
Weingart Plier Universal
With TC 45°



DE-1378
Bird Beak Angled
Bending Plier

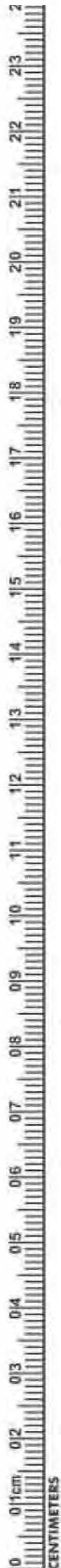

PLIERS FOR ORTHODONTICS & PROSTHETICS

- Щипцы для ортодонтии и протезирования
- Pincers pour l'orthodontie et la prothèse
- Zangen für Kieferorthopädie und Prothetik
- Щипці для ортодонції та протезування
- Alicates para ortodoncia y prótesis
- أداة لتلويح الأسنان پروتيزيس

LAP JOINT PLIERS



DE-1379
How Plier Curved



DE-1380
Hammer Head Tie Back Plier



DE-1381
Arch Forming Pliers



DE-1382
Regular Tweed Arch
Forming Pliers 1.78mm



DE-1383
Bird Beak with Cutter
Pliers 3 Groove



DE-1384
Light Wire Bird Beak Pliers
With Groove

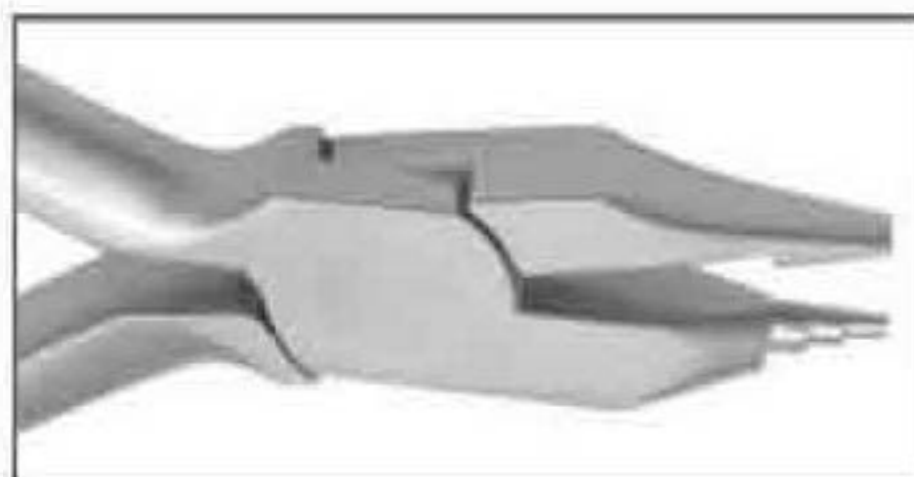

DE-1385
Tweed Loop Plier



DE-1386
Tweed Cutter Plier With
Groove



DE-1387
Round Nose Plier



DE-1388
Adam Plier



DE-1389
Jara Beak Plier



DE-1390
Band Seating Plier

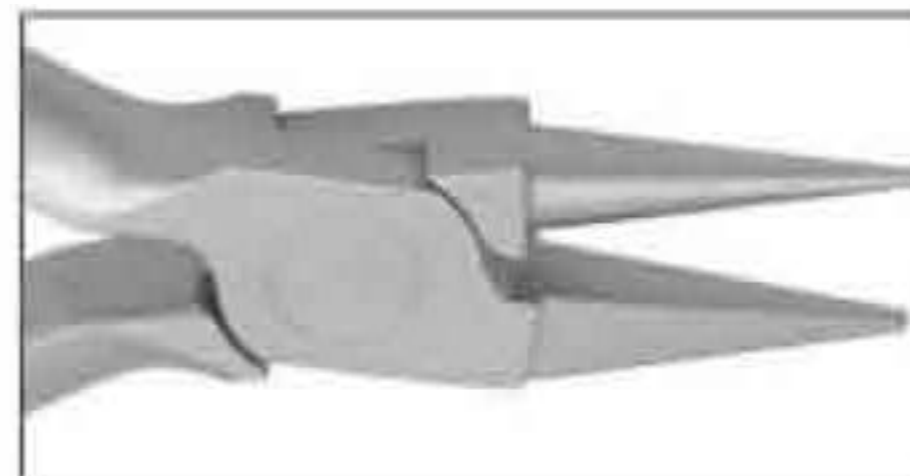

DE-1391
Light Wire Bird Beak
Long Plier



DE-1392
Light Wire plier two step
groove 0.51mm/.020"

INCHES
0 1 2 3 4 5 6 7 8 9

PLIERS FOR ORTHODONTICS & PROSTHETICS

- Щипцы для ортодонтии и протезирования
- Pincers pour l'orthodontie et la prothèse
- Zangen für Kielerorthopädie und Prothetik
- Щипці для ортодонції та протезування
- Alicates para ortodoncia y prótesis
- أداة لفخيم الأسنان بروستتيس

LAP JOINT PLIERS



DE-1393
Ball Hook Crimping Plier



DE-1394
Marcotte Looping Plier



DE-1395
Tweed Loop Plier

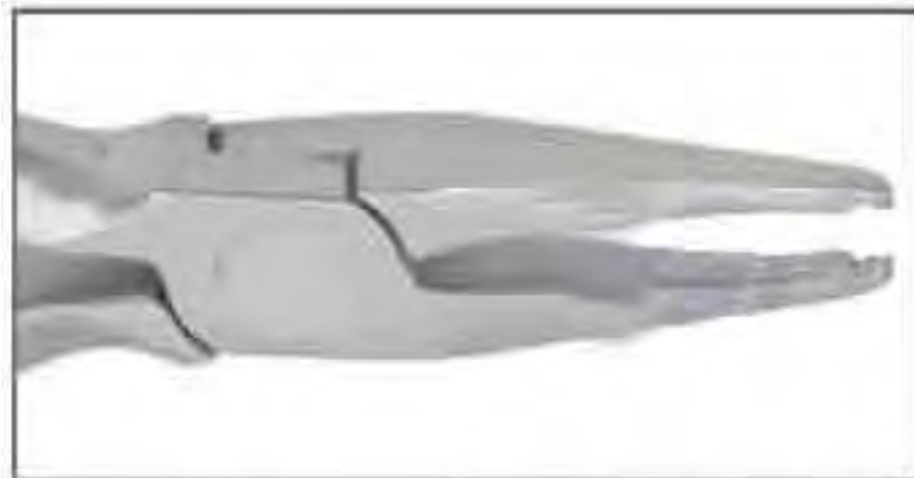

DE-1396
Palatal Arch Plier



DE-1397
Nance Plier



DE-1398
Young Plier with Grooved



DE-1399
Wingurt Plier Slim



DE-1400
Tweed loop Forming
Plier TC.



DE-1401
Wingurt Utility Plier



DE-1402
De La Rosa Pliers
with Grooved



DE-1403
De La Rosa Pliers



DE-1404
Crown and Band
Contouring Pliers



DE-1405
Flat Nose Plier with Serration



DE-1406
Flat Nose Plier Smooth



DE-1407
Slop V Bending Plier

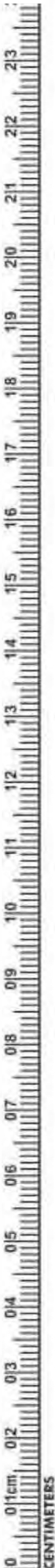

PLIERS FOR ORTHODONTICS & PROSTHETICS

- Щипцы для ортодонтии и протезирования
- Pincas pour l'orthodontie et la prothèse
- Zangen für Kieferorthopädie und Prothetik
- Щипці для ортодонції та протезування
- Alicates para ortodoncia y prótesis
- كمشة لتقويم الأسنان برومشتيس

LAP & L-KEY JOINT PLIERS



DE-1408
Hollowchop Contouring
Pliers



DE-1409
Lap-Joint Three Prong Plier



DE-1410
Three Prong Pliers Regular



DE-1411
Lingual Plier Weingart
Regular Long Handle 35°



DE-1412
Lingual Plier Long Handle
90° Angled



DE-1413
Lingual Weingart Plier Fine
Long Handle 60° Angled



DE-1414
Direct Bonding Bracket
Remover Plier TC.



DE-1415
Pin & Ligature Cutters
TC.



DE-1416
Mini Pin & Ligature
Cutter TC.



DE-1417
Standard Ligature
Cutter TC.



DE-1418
V Bend Stop Plier
TC.



DE-1419
Angled Direct Bond Bracket
Remover TC.





DE-1420
Distal end Cutter, Safety Hold Plier
(Ideal for Cutting Wire) TC.



DE-1421
Hook Crimping Plier Angled
Straight TC.



DE-1422
3 Prong Clasp Adjustable
Plier TC.



DE-1423
Utility Plier Weingart TC.



DE-1424
Direct Bracket Remover
TC.



DE-1425
Straight Direct Bond Bracket
Remover TC.



DE-1426
Pin Holding Plier TC.



DE-1427
Hard wire cutters



DE-1428
Elastic Separating Plier
Round Handle



DE-1429
Elastic
Separating Plier



DE-1430
DE-1431
Smaha
Elastomeric
ligature
placing forceps
140 mm



DE-1432
Elastomeric
ligature placing
forceps with
groove
Falcon 140 mm



DE-1433
Elastomeric
ligature placing
forceps with
groove
Falcon 140 mm



Normal Anatomy – Dental Implants

Bone Level Normal
(No Bone Loss)

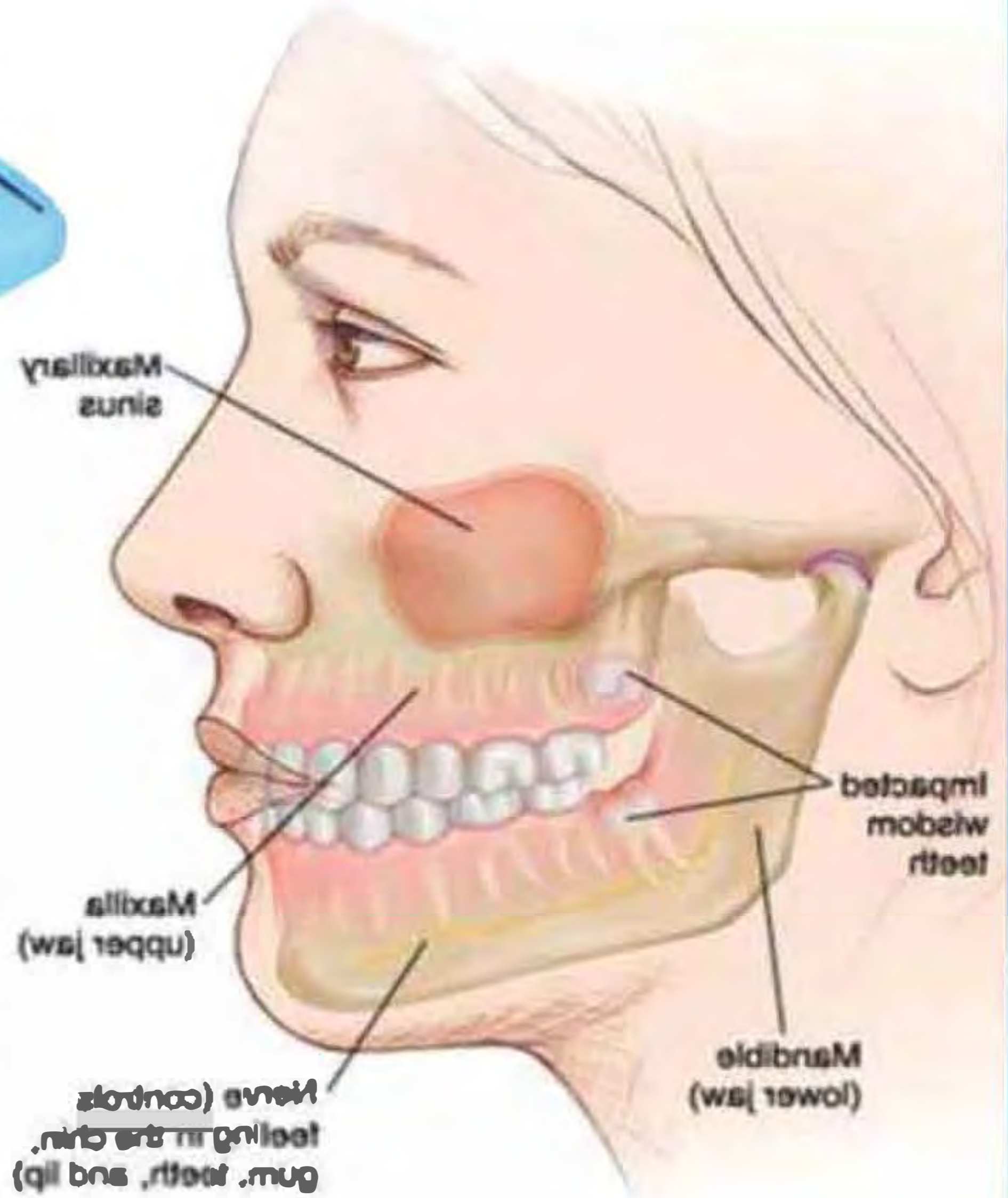
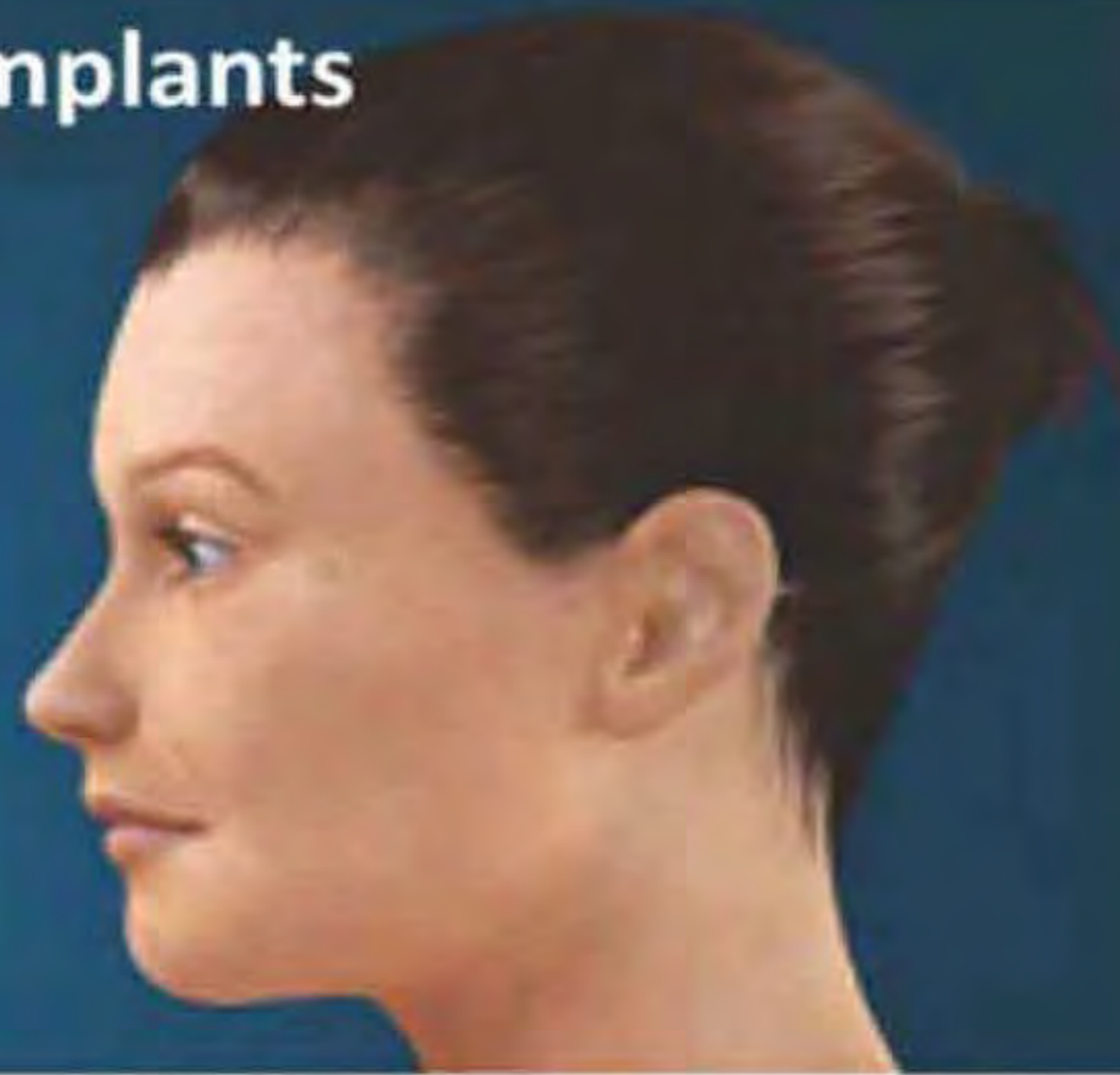
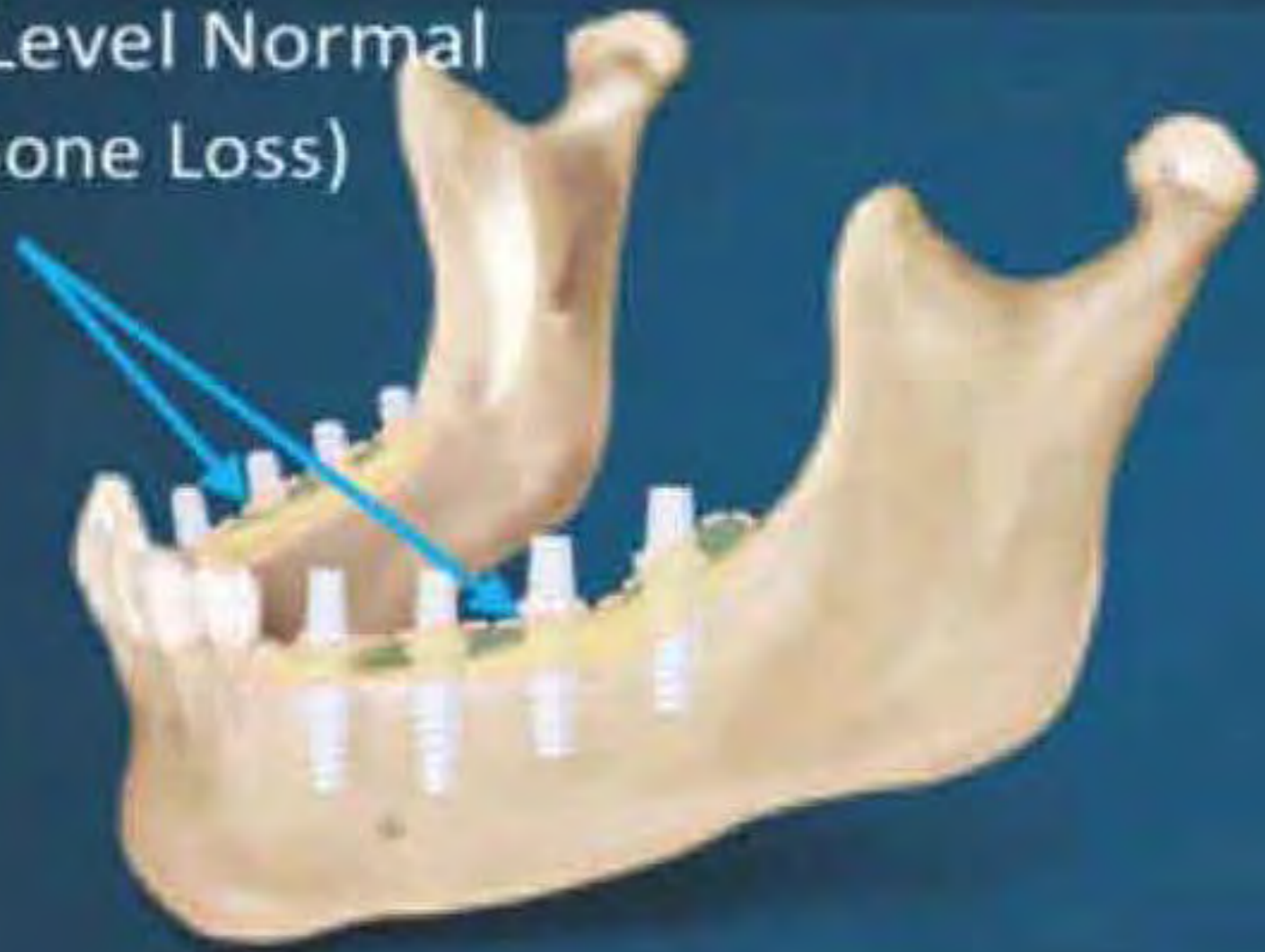

- Инструменты для имплантологии
- Implantologie
- Implantologie

- Инструменти для имплантології
- implantologia
- زراعة الأسنان

IMPLANT GAGES



DE-1434
Multifunctional Meter
Length 90 mm,
different sizes,
8-10-11mm,
corrosion-resistant

DE-1435
Multifunctional Meter
Length 90 mm,
different sizes,
5-13-15-17 mm,
corrosion-resistant

DE-1436
Measuring Probe
Length 170 mm,
hand shape or flexible
(6-8-10-14-16 mm),
corrosion-resistant

DE-1437

DE-1438

DE-1439

DE-1440

IMPLANT GAGES



DE-1441

DE-1442

DE-1443

- Инструменты для имплантологии
 - Implantologie
 - Implantologie
- Инструменти для имплантології
 - Implantologia
 - زراعة الأسنان



DE-1444
Clamp, Osteometer
Length about 155 mm,
ridge width measurement,
two-sided scale,
measuring
range 0 - 25 mm



DE-1445
Measuring Loop
straight length 90 mm,
measuring range
0 - 40 mm,



DE-1446
Measuring Loop
angled, length 90 mm,
measuring range
0 - 40 mm.



DE-1447
Measuring loop, Castroviejo
angled, length 175 mm,
measuring range 0 - 40 mm,
with window



DE-1448
Boley Gauge
Stainless Steel



DE-1449
Measuring Loop
angled, length
175 mm,
measuring range
0 - 40 mm,



DE-1450
Measuring Loop
straight length
175 mm,
measuring range
0 - 40 mm,



DE-1451
Fig. 1
Iwanson
spring caliper
For metal and
porcelain.



DE-1452
Fig. 2
Iwanson
spring caliper
For wax.



DE-1453
Bone Thickness Gauge
40mm, 180mm



DE-1454
Gauge
for measuring
distances
(0 - 90 mm).



- Инструменты для имплантологии
- Implantologie
- Implantologie

- Инструменти для имплантології
- Implantolois
- زراعة الأسنان

BLACK TITANIUM COLOUR COATED INSTRUMENTS

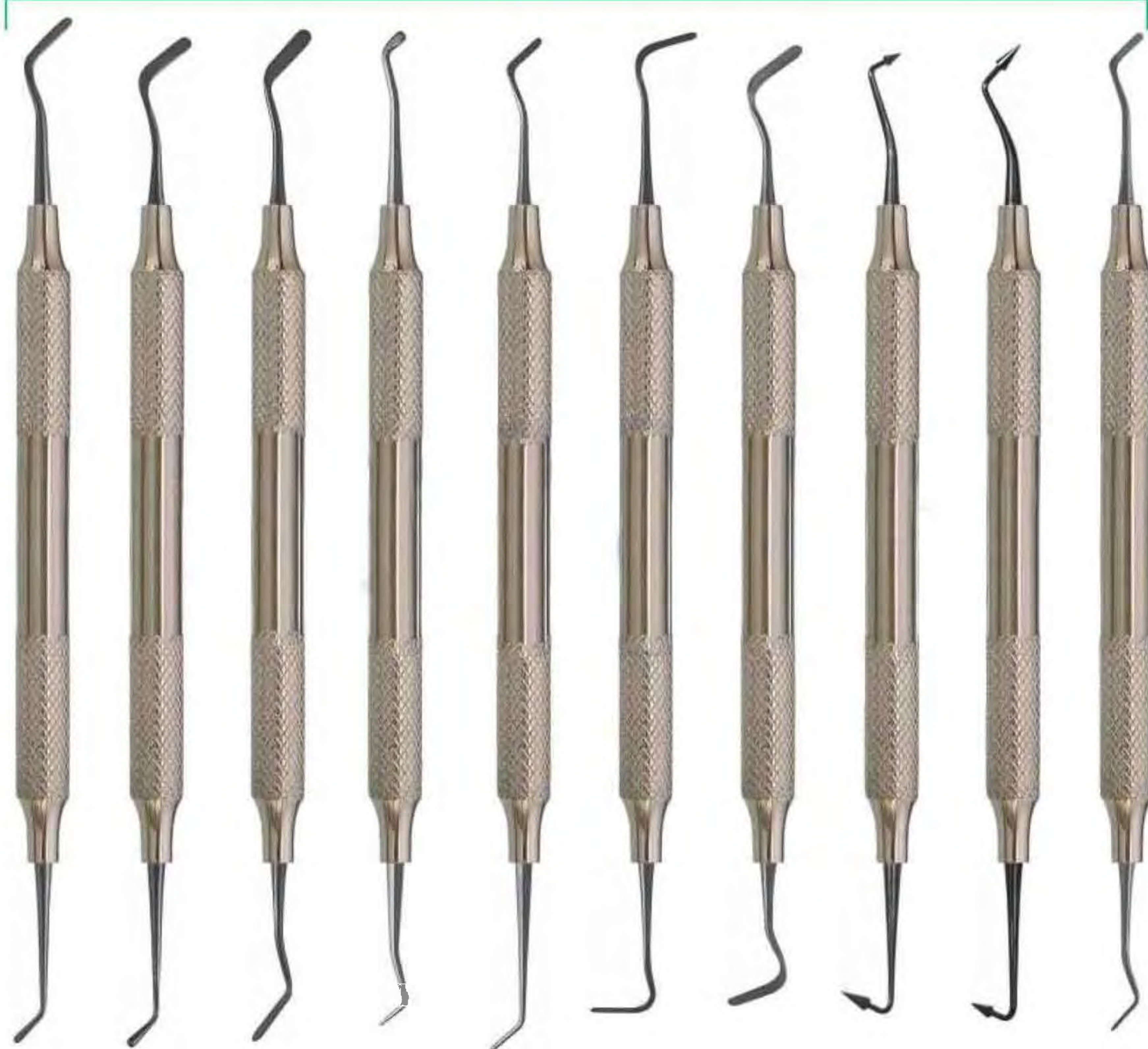
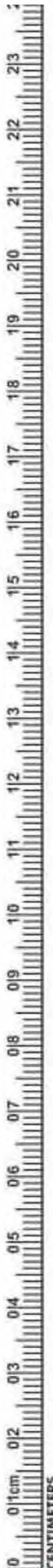

DE-1455
#1

DE-1456
#2

DE-1457
#3
Extra-Flex

DE-1458
Micro-Mini

DE-1459
Mini 1

DE-1460
Mini 4
Extra-Flex

DE-1461
#4
Extra-Flex

DE-1462
#5
Flexi-Thin

DE-1463
#6
Flexi-Thin

DE-1464
Mini 3
Extra-Flex

- Инструменты для имплантологии
 - Implantologie
 - Implantologie
- Інструменти для імплантології
 - Implantologia
 - زراعة الأسنان

BLACK TITANIUM COLOUR COATED INSTRUMENTS

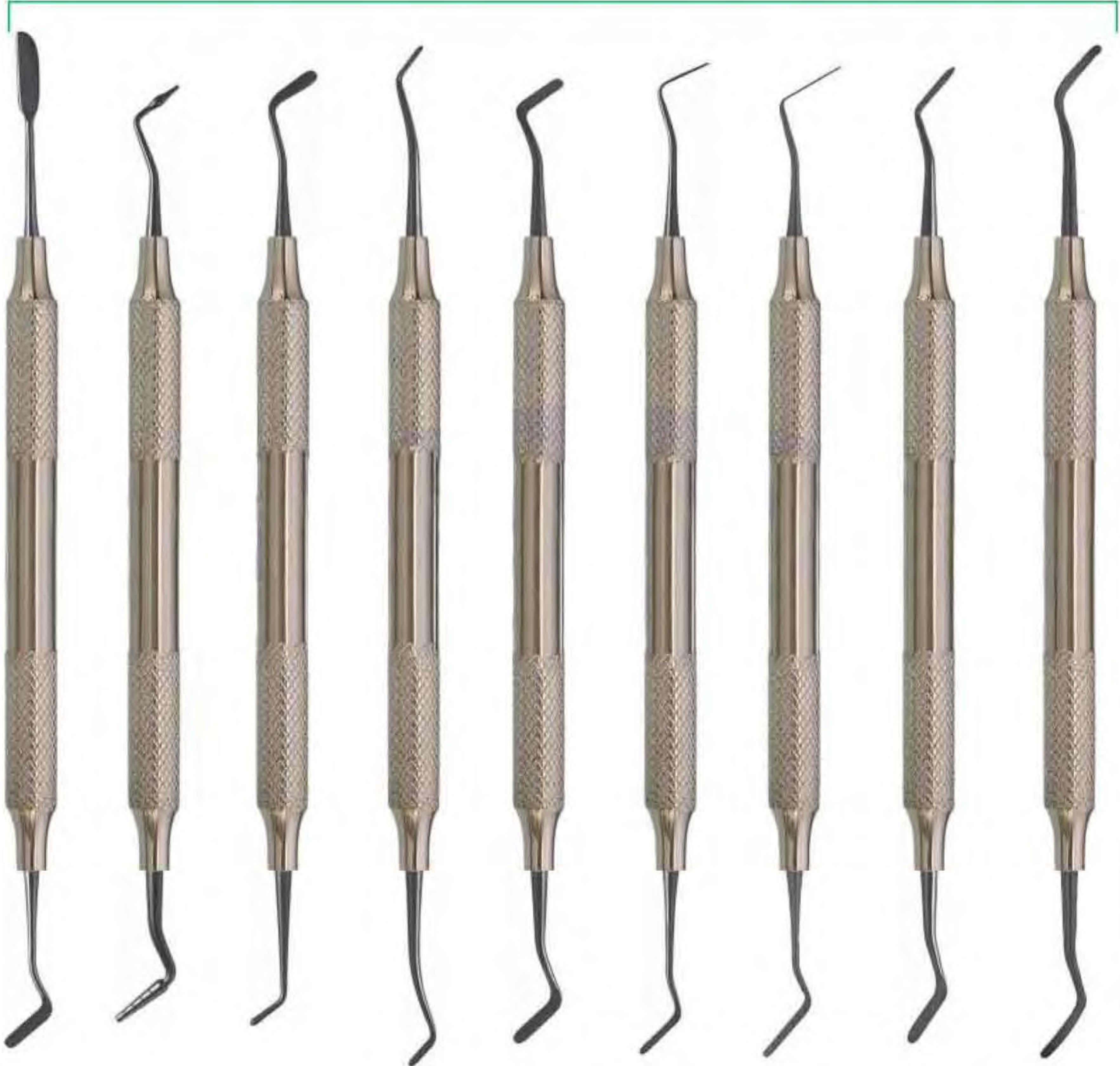

DE-1465
AB1
Boghosian

DE-1466
AB2
Boghosian

DE-1467
W3

DE-1468
8A

DE-1469
4/5
Gregg

DE-1470
Interproximal
Carver

DE-1471
Interproximal
Carver, Long

DE-1472
A6

DE-1473
Contouring
instrument

INCHES
0 1 2 3 4 5 6 7 8 9

- Инструменты для имплантологии
- Implantologie
- Implantologie

- Инструменти для имплантології
- implantologia
- زراعة الأسنان

BLACK TITANIUM COLOUR COATED INSTRUMENTS

BURNISHERS

FREEDMAN BURNISHERS

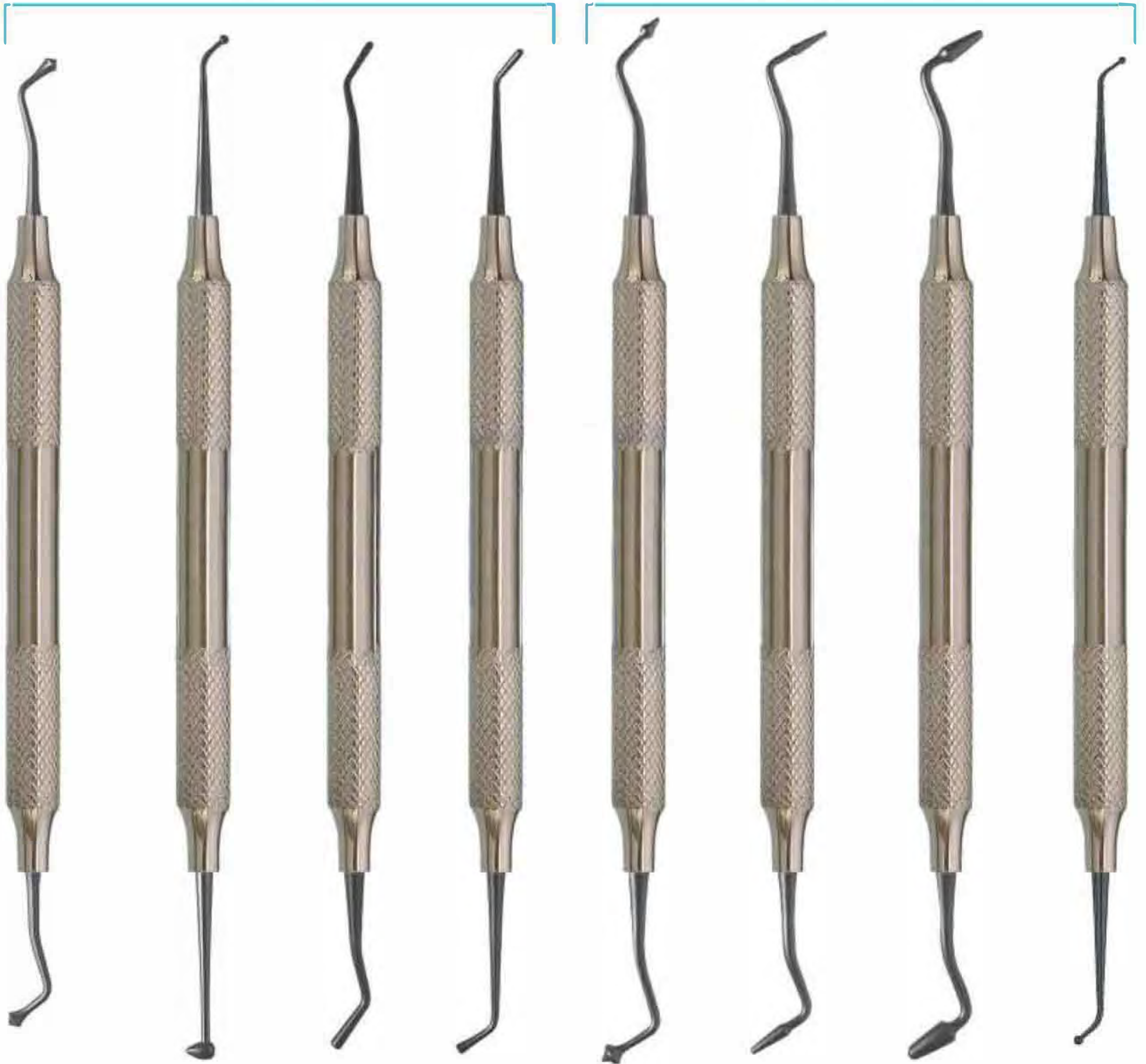

DE-1474
21B

DE-1475
27/29

DE-1476
2
Ladmore

DE-1477
3
Ladmore

DE-1478
Freedman
"Duckhead"

DE-1479
Freedman
Small Contact
Forming

DE-1480
Freedman
Large Contact
Forming

DE-1481
Small/
Medium Ball
Burnisher

IMPLANTOLOGY

- Инструменты для имплантологии
 - Implantologie
 - Implantologie
- Инструменти для имплантології
 - implantologia
 - زراعة الأسنان

BLACK TITANIUM COLOUR COATED INSTRUMENTS

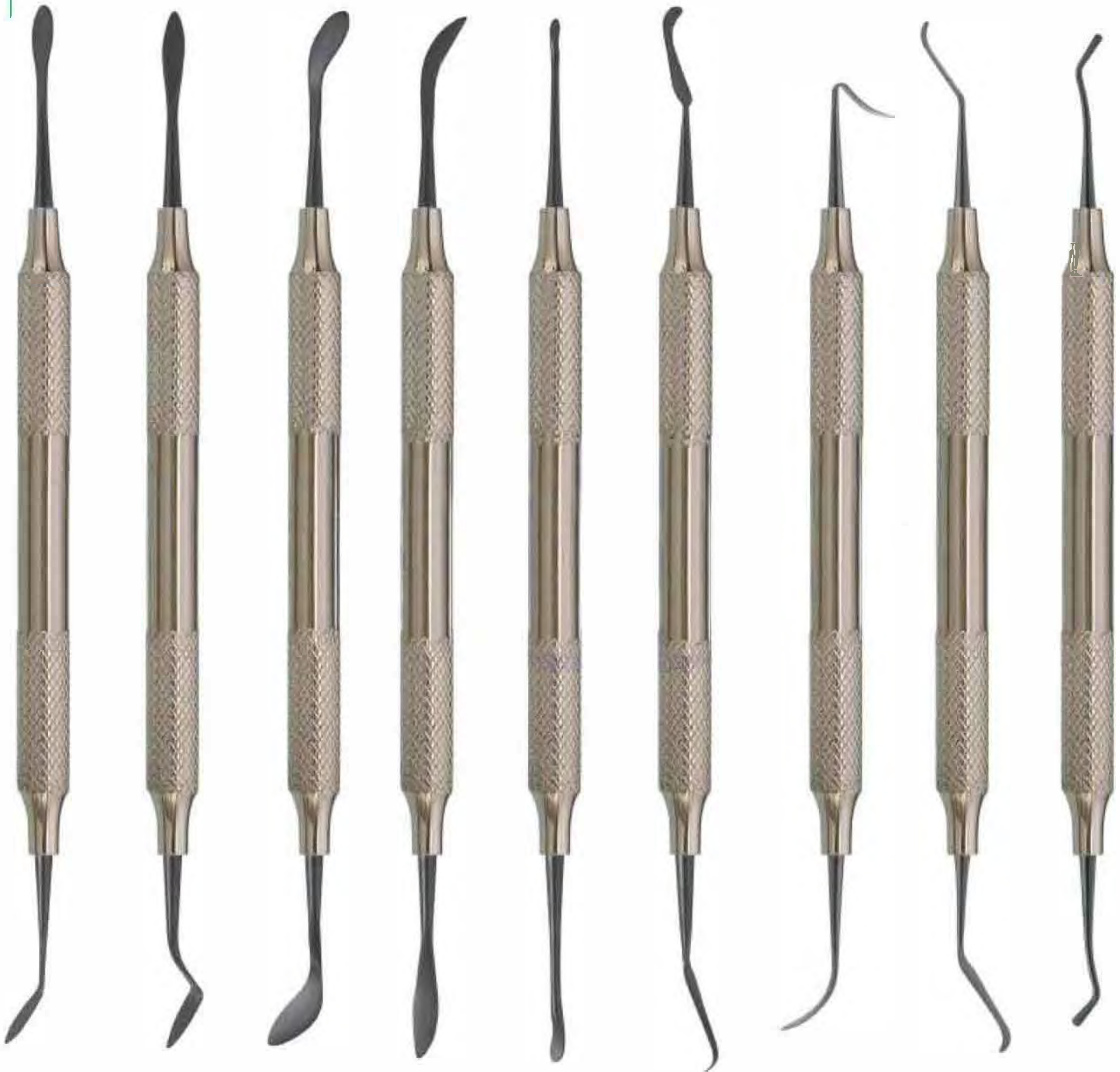

DE-1482
A
Cosmetic
Contouring

DE-1483
B
Cosmetic
Contouring

DE-1484
C
Cosmetic
Contouring

DE-1485
D
Cosmetic
Contouring

DE-1486
E
Cosmetic
Contouring

DE-1487
F
Cosmetic
Contouring

DE-1488
Marginal Ridge
& Embrasure
Shaping Instrument

DE-1489
Occlusal
Anatomy
Instrument

DE-1490
Composite
Packing
Instrument



INCHES

- Инструменты для имплантологии
 - Implantologie
 - Implantologie
- Инструменти для имплантології
 - Implantologia
 - زراعة الاسنان

BLACK TITANIUM COLOUR COATED INSTRUMENTS

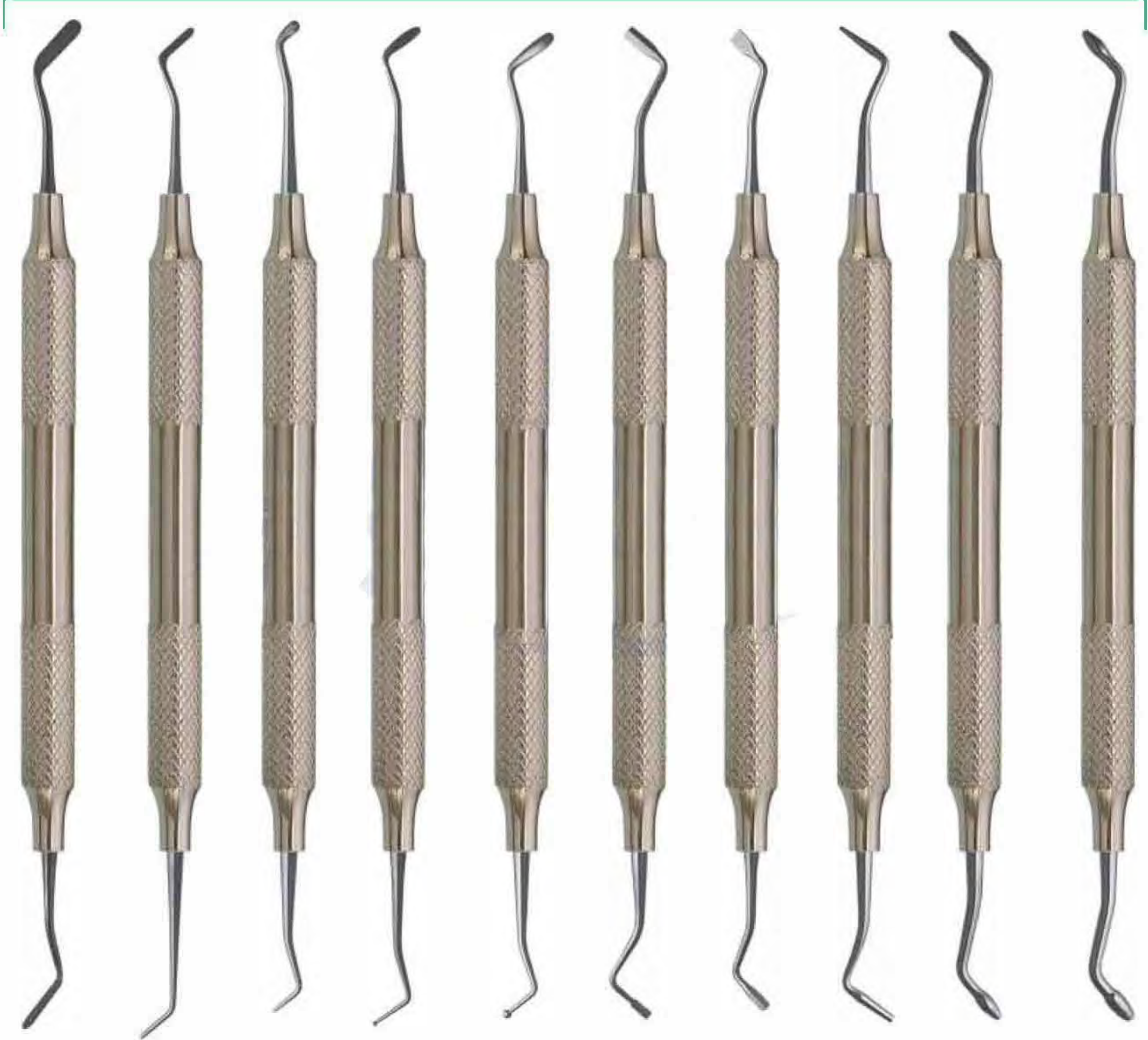
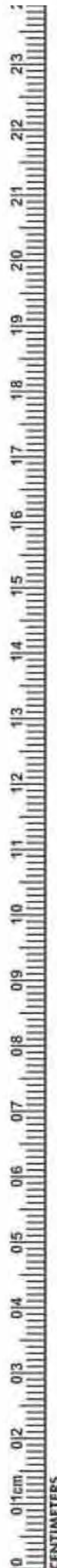

DE-1491 #3 Extra-Flex	DE-1492 Mini 1	DE-1493 Micro-Mini	DE-1494 Medium Placing/ Condensing	DE-1495 Large Placing/ Condensing	DE-1496 OT Tanner	DE-1497 3 Hollenback	DE-1498 5A	DE-1499 Small/Medium Contact/ Forming	DE-1500 Medium/Large Contact/ Forming
------------------------------------	--------------------------	------------------------------	--	---	--------------------------------	-----------------------------------	----------------------	---	---

IMPLANTOLOGY

- Инструменты для имплантологии
- Implantologie
- Implantologie

- Інструменти для імплантології
- implantologia
- زراعة الأسنان

2019/05/24/09:28

SINUS LIFT INSTRUMENTS HOLLOW HANDLE 9.5MM LENGTH 170MM

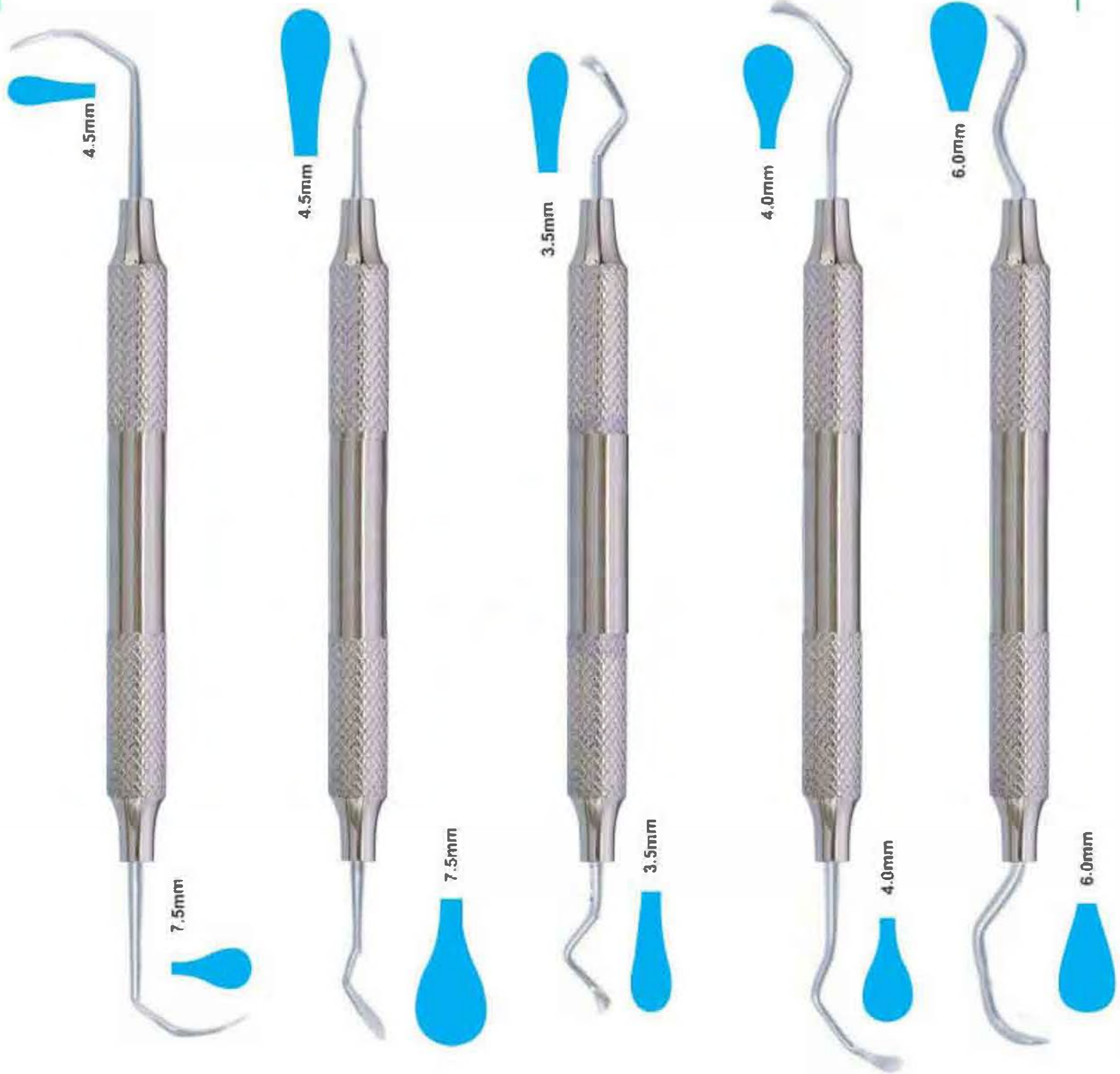

DE-1501
Sinus Lift Elevator

DE-1502
Sinus Lift Elevator

DE-1503
Sinus Lift Elevator

DE-1504
Sinus Lift Elevator

DE-1505
Sinus Lift Elevator



- Инструменты для имплантологии
- Implantologie
- Implantologie
- زراعة الأسنان
- Implantologia

SINUS LIFT INSTRUMENTS HOLLOW HANDLE 9.5MM LENGTH 170MM

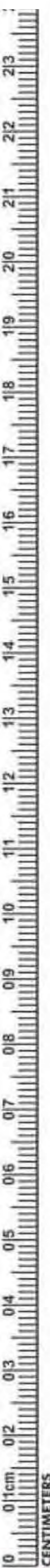

DE-1506
Sinus Lift Elevator



DE-1507
Sinus Lift Elevator



DE-1508
Sinus Lift Elevator



DE-1509
Sinus Lift Elevator

- Инструменты для имплантологии
- Implantologie
- Implantologie
- Инструменти для имплантології
- Implantologia
- زراعة الأسنان

IMPLANT SINUS LIFT INSTRUMENTS HOLLOW HANDLE 9.5MM LENGTH 170MM

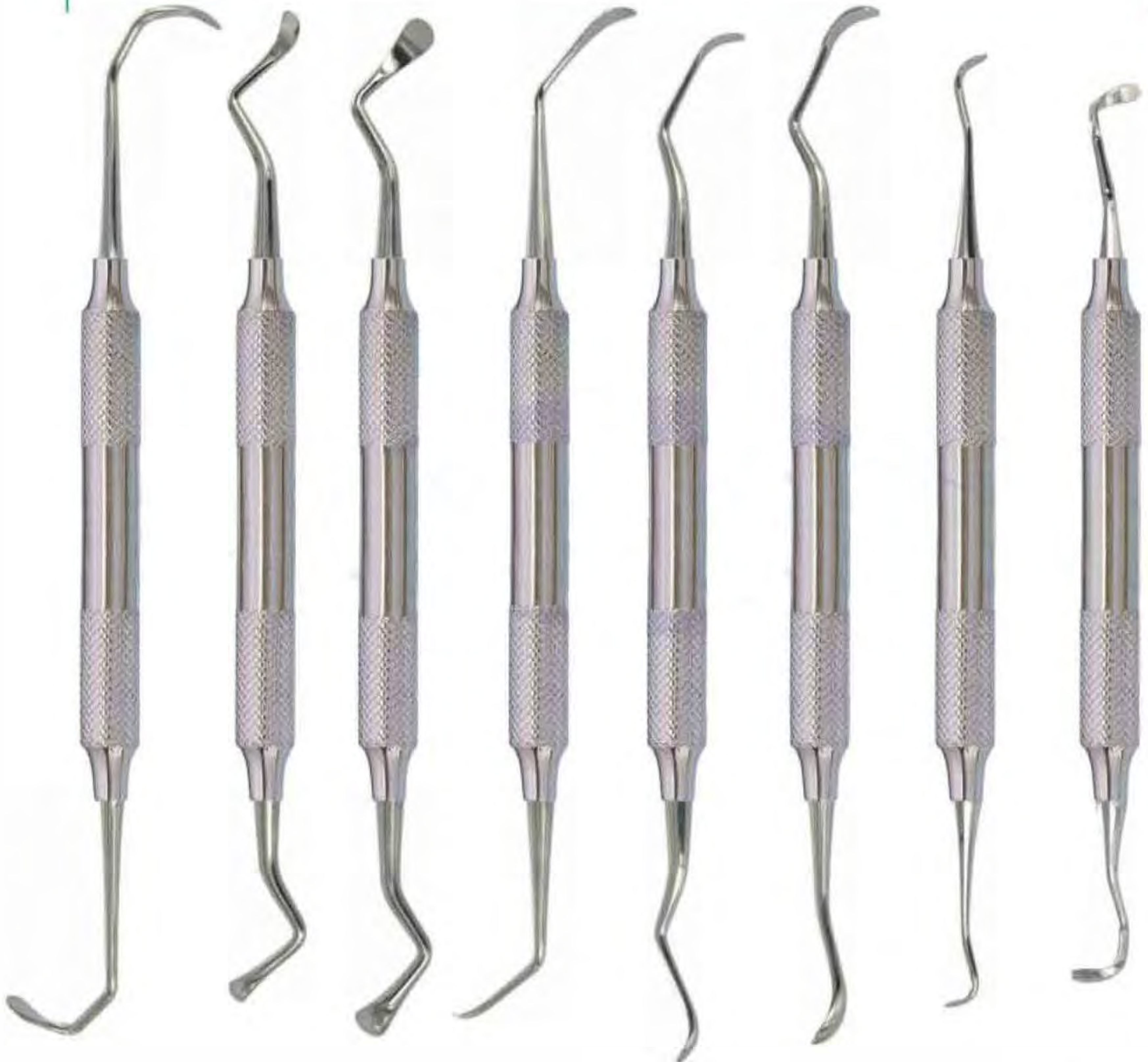

DE-1510
Acute 6577

DE-1511
Sinus1

DE-1512
Sinus2

DE-1513
Sinus3,
Obtuse 6578

DE-1514
Sinus4

DE-1515
Sinus5

DE-1516
Sinus6

DE-1517
Sinus7

- Инструменты для имплантологии
- Implantologie
- Implantologie
- Инструменти для имплантології
- implantologia
- زراعة الأسنان

SINUS LIFT INSTRUMENTS HOLLOW HANDLE 9.5MM LENGTH 170MM

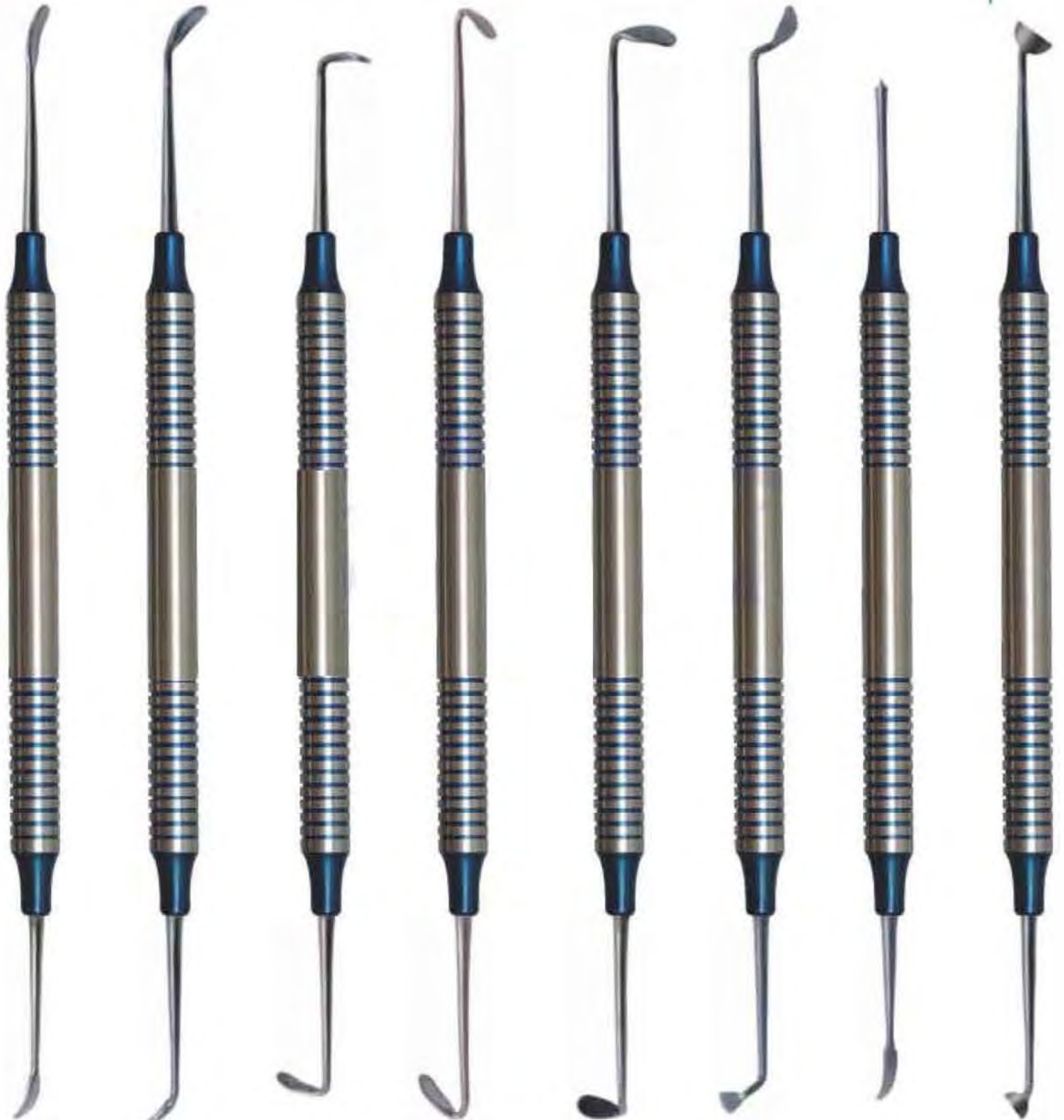

DE-1518 Sinuslift 1 DE-1519 Sinuslift 2 DE-1520 Sinuslift 3 DE-1521 Sinuslift 4 DE-1522 Sinuslift 5 DE-1523 Sinuslift 6 DE-1524 Membrane 3Positioning 1 DE-1525 Condenser 1

IMPLANTOLOGY

- Инструменты для имплантологии
- Implantologie
- Implantologie

- Инструменти для имплантології
- Implantologia
- زراعة الأسنان

Sinus Lift Instrument,
Flexible Sinus Lift instruments
reduce the risk of perforation of the
"Schneider's membrane"



DE-1526
Fig. 1

DE-1527
Fig. 2

DE-1528
Fig. 3

Sinus Lift Elevator,
10 mm Straight grip
Length 175 mm, Sinus lift elevators, dull,
for gentle peeling and lifting the
Schneider membrane



DE-1529
Fig. 1

DE-1530
Fig. 2

DE-1531
Fig. 3

Sinus lift instrument
10 mm Straight grip Length 180 mm,
Buser (B1, B2, B3) raspatories,
quality medical stainless steel,
corrosion-resistant



DE-1532
B01

DE-1533
B02

DE-1534
B03



- Инструменты для имплантологии
- Instrumenti для імплантології
- Implantologie
- implantologia
- Implantologie
- زراعة الأسنان

Sinus lift Instrument 10 mm Straight grip Sinus lift elevators, blunt or sharply curved (H01, H02, K03, K04, K78, K77)

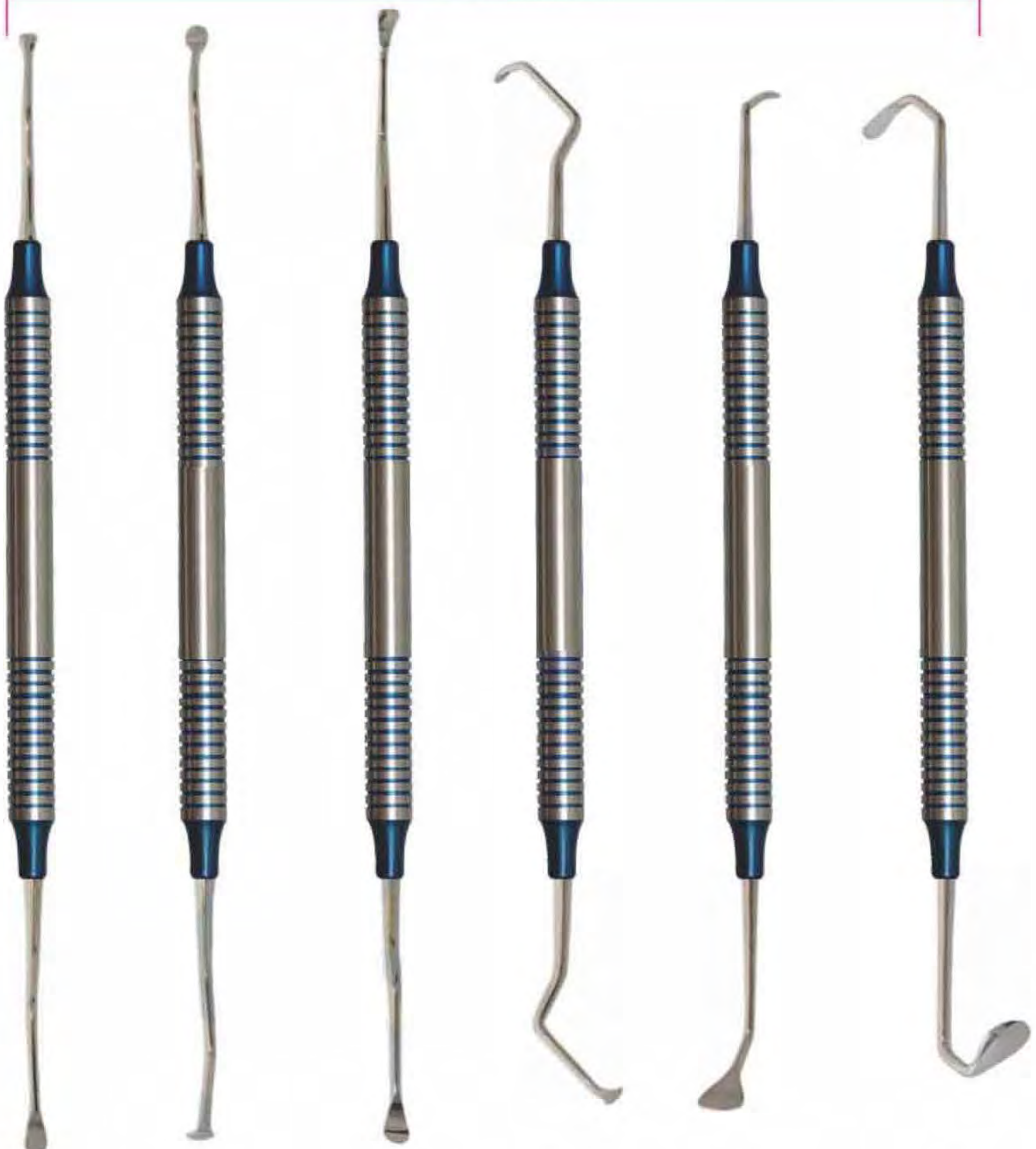

DE-1535
Sinus lift instrument
H01

DE-1536
Sinus lift instrument
H02

DE-1537
Sinus lift instrument
K03

DE-1538
Sinus lift instrument
K04

DE-1539
Sinus lift instrument
K78

DE-1540
Sinus lift instrument
K77

- Инструменты для имплантологии
- Implantologie
- Implantologie
- Инструменти для імплантології
- Implantologia
- زراعة الأسنان

SINUS LIFT INSTRUMENT

Sinus Lift Elevators, 10 mm Hollow Handle length 170mm Blunt Curved Set of 6 Pcs

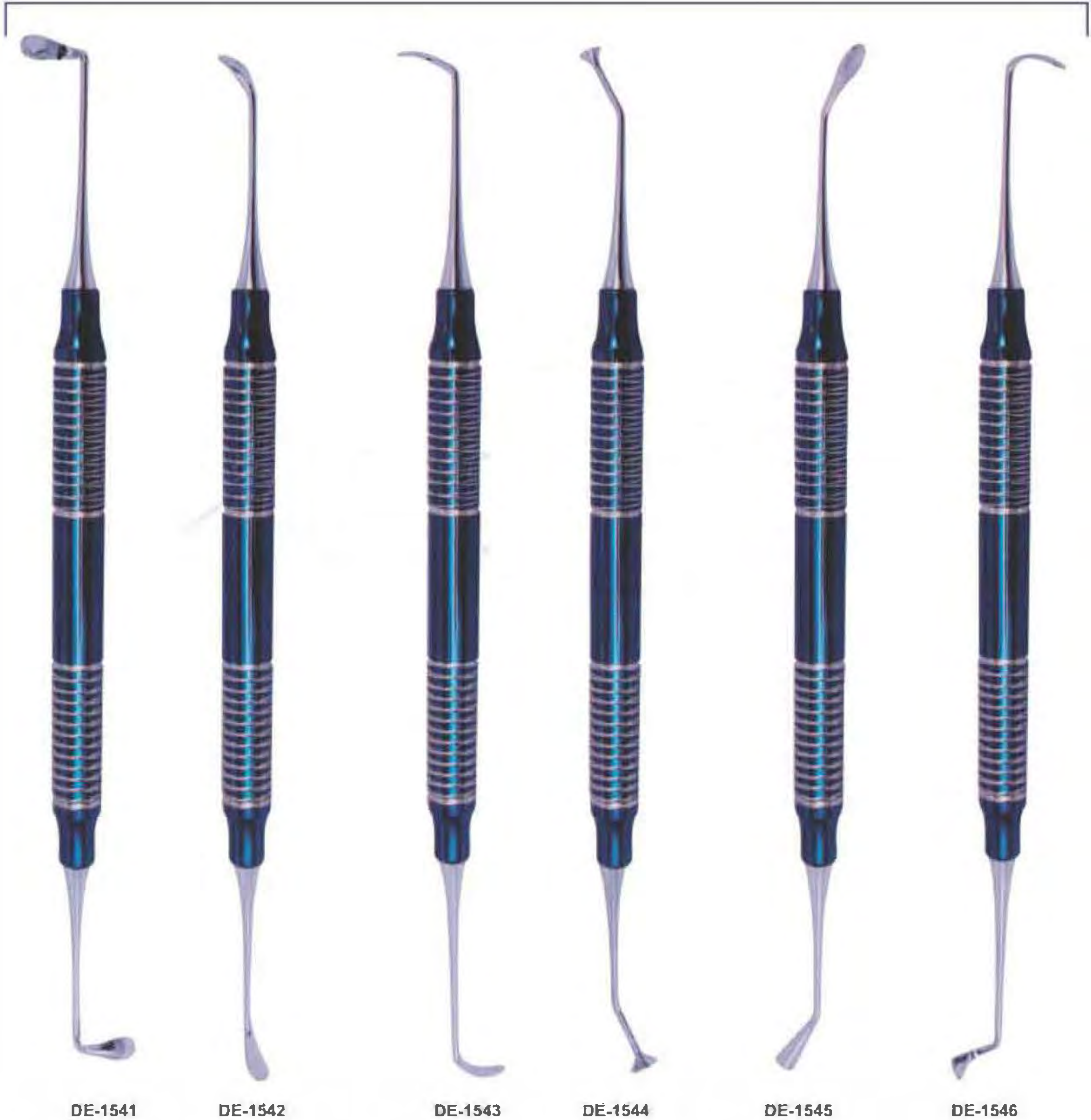

DE-1541

DE-1542

DE-1543

DE-1544

DE-1545

DE-1546

- Инструменты для имплантологии
- Implantologie
- Implantologie
- زراعة الأسنان
- Instrumenti для имплантології
- implantologia
- زراعة الأسنان

IMPLANT SINUS LIFT INSTRUMENTS
PERIODONTAL SURGERY SURGICAL CHISELS
KRAMER NEVINS SINUS LIET

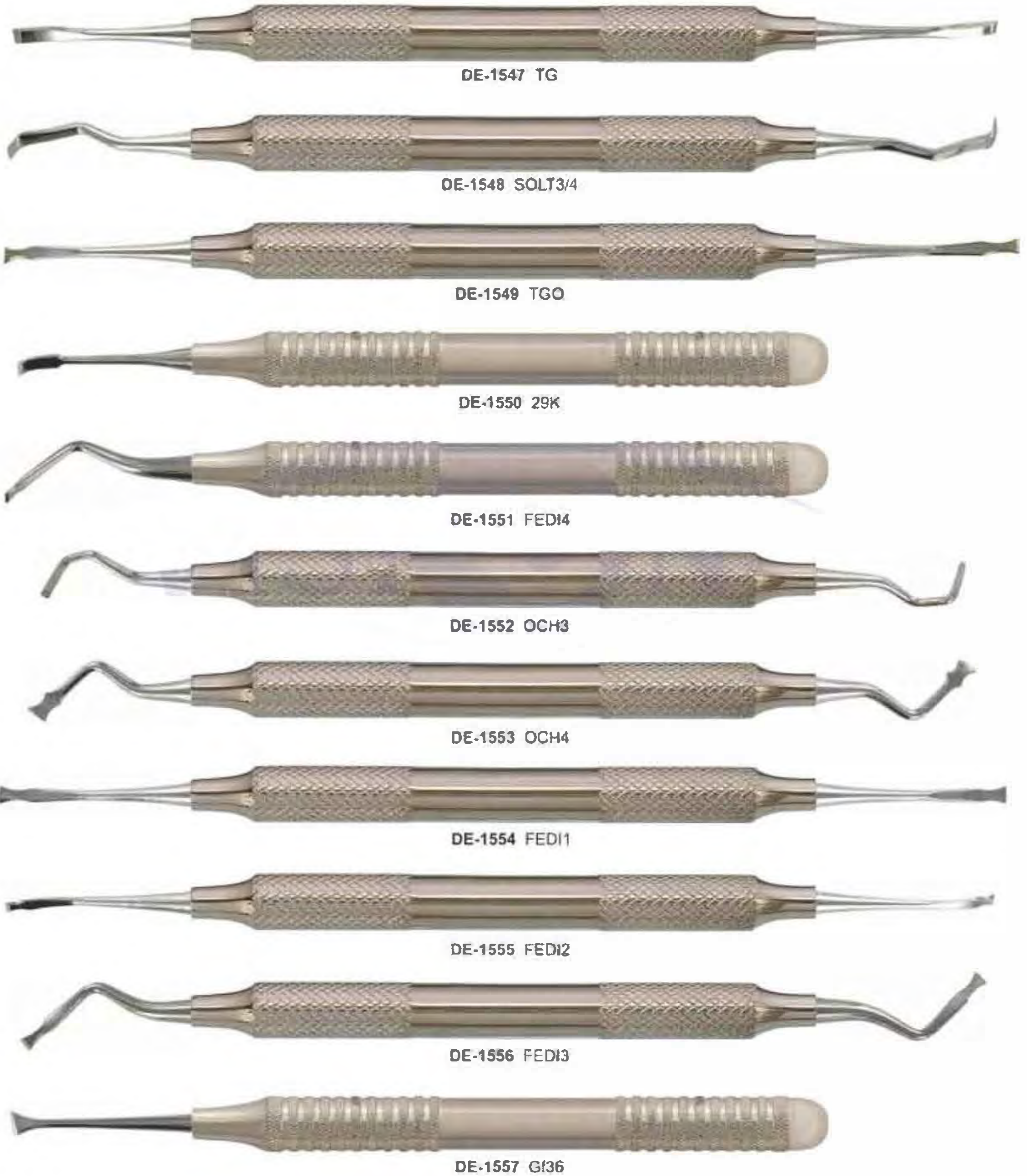

- Инструменты для имплантологии
- Implantologie
- Implantologie

- Instrumenti для имплантології
- Implantologia
- زراعة الأسنان

IMPLANT

SURGICAL CHISELS

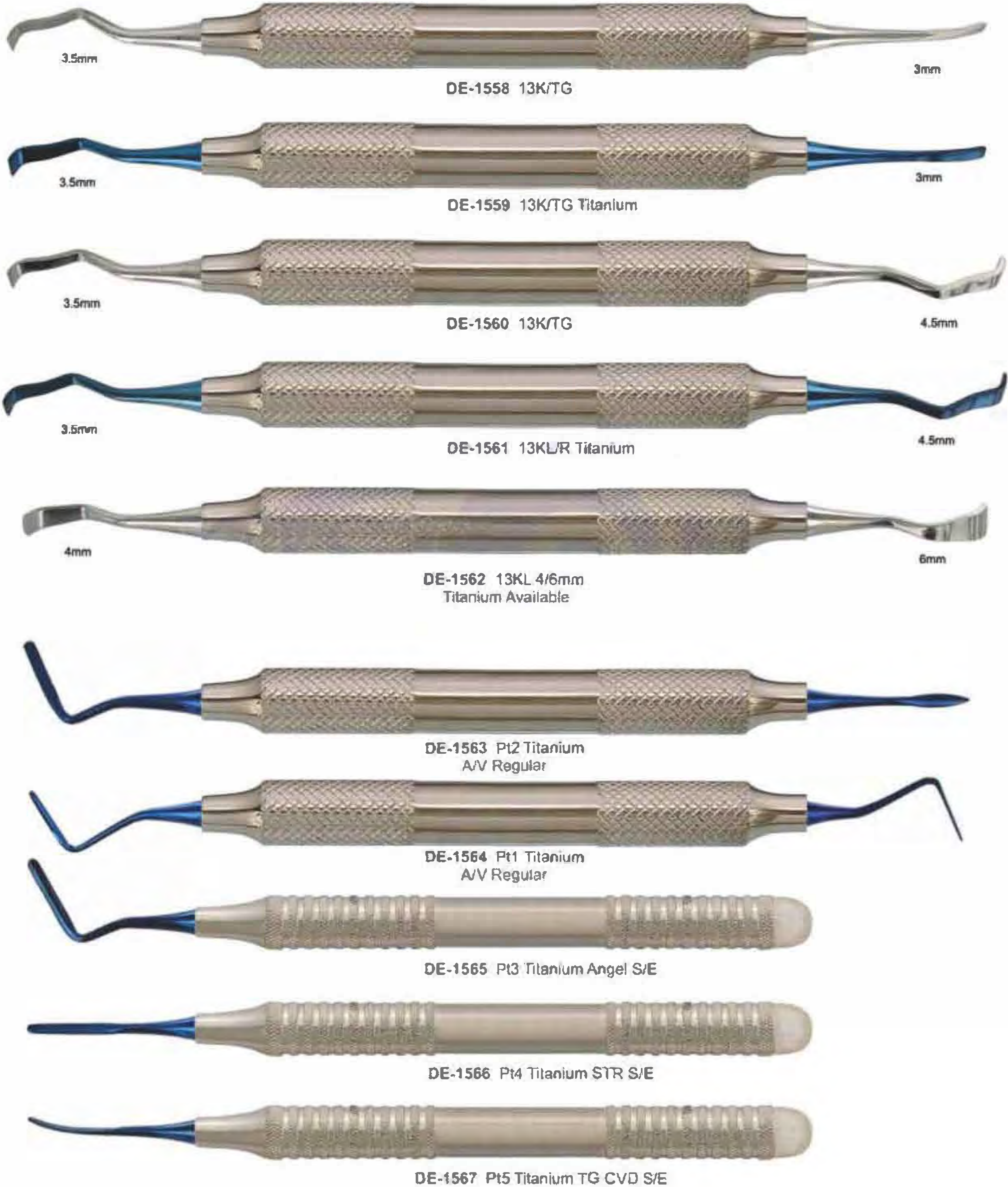

- Инструменты для имплантологии
- Implantologie
- Implantologie

- Инструменти для имплантології
- implantologia
- زراعة الأسنان

MIXING SPATULA WITH SHOVEL



DE-1568
Bone Carrier
Titanium



DE-1569
Raspator, Prichard
Length 180 mm,
10 mm hollow handle,
double-ended
10.5 mm | 4.5 mm,



DE-1570
Raspator, Prichard
Length 180 mm,
10 mm hollow handle,
double ended



DE-1571
Raspator, Prichard
Length 180 mm,
10 mm hollow handle,
double-ended
10.5 mm | 4.5 mm,



DE-1572
Mixing Spatula
with shovel
17cm



DE-1573
Mixing Spatula
with shovel
18.5cm



- Инструменты для имплантологии
 - Implantologie
 - Implantologie
- Инструменти для имплантології
 - implantologia
 - زراعة الأسنان

BONE GRAFTING INSTRUMENTS COMPACTOR /TAMPERS

Product offering includes instruments for harvesting, mixing and compacting bone Provides clinicians with the proper instrumentation for bone grafting procedures Weighted bone basin Prevents tipping and spilling of bone and other materials during mixing



DE-1574
Graft Packer,
Concave Tips
DE 4/6mm

DE-1575
Bone Spoon/
Packer DE 3mm

DE-1576
Graft Packer,
Serrated Tips
DE 6/8mm

DE-1577
Graft Packer,
Serrated Tips
DE 3/4mm

DE-1578
Graft Packer,
Smooth Tips
DE 5/8mm

DE-1579
Titanium graft packer/
placement site depth
gauge 3.3mm & 4.0mm
Diameter tips Marked
at 8, 11, 13, 15 & 18mm

DE-1580
Graft Material Spoon
Concave Tip For
Larger Grafts

INCHES
0 1 2 3 4 5 6 7 8 9

- Инструменты для имплантологии
- Implantologie
- Implantologie

- Инструменти для имплантології
- implantologia
- زراعة الأسنان

BONE GRAFTING INSTRUMENTS



DE-1581
Blade and pusher
Length 180 mm,
for straight or angled,
blade: 15 x 5 mm;
pusher: 4 mm diameter
Straight

DE-1582
Blade and pusher
Length 180 mm,
for straight or angled,
blade: 15 x 5 mm,
pusher: 4 mm diameter
angular

DE-1583
Spoon and pusher
Length 180 mm,
for angled spoon:
10 x 5 mm; pusher:
diameter 3 mm

DE-1584
Tunnellerung
Instrument
length 175 mm,

DE-1585
Tunnelierungs
Instrument
length 175 mm,
different designs

DE-1586
Tamper
Length 170 mm,
for bone material,
double-ended,
diameter 3.2 mm
(2-4-6-8-10) and diameter
2.5mm (2-4-6-8-10)



- Инструменты для имплантологии
 - Implantologie
 - Implantologie
- Инструменти для имплантології
 - Implantologia
 - زراعة الأسنان

BONE GRAFTING INSTRUMENTS

Pluggers Clarizio

Length 160 mm, with titanium tips for mixing and pouring of autologous, heterologous bone substitute material, diameter (3/4 or 6/8 mm)



DE-1587 Ø 4mm
DE-1688 Ø 5mm
Compactor
150mm



DE-1589
Sinus Window
Bone Tamper
4 mm



DE-1590
Sinus Window
Bone Tamper
7 mm



DE-1591
6/8mm



DE-1592
3/4mm

- Инструменты для имплантологии
 - Implantologie
 - Implantologie
- Инструменти для имплантології
 - implantologia
 - زراعة الأسنان

SPOON AND PUSHER (TRINOVO)

Trinovo handle, different workers, for bone material, high-grade medical stainless steel, corrosion-resistant

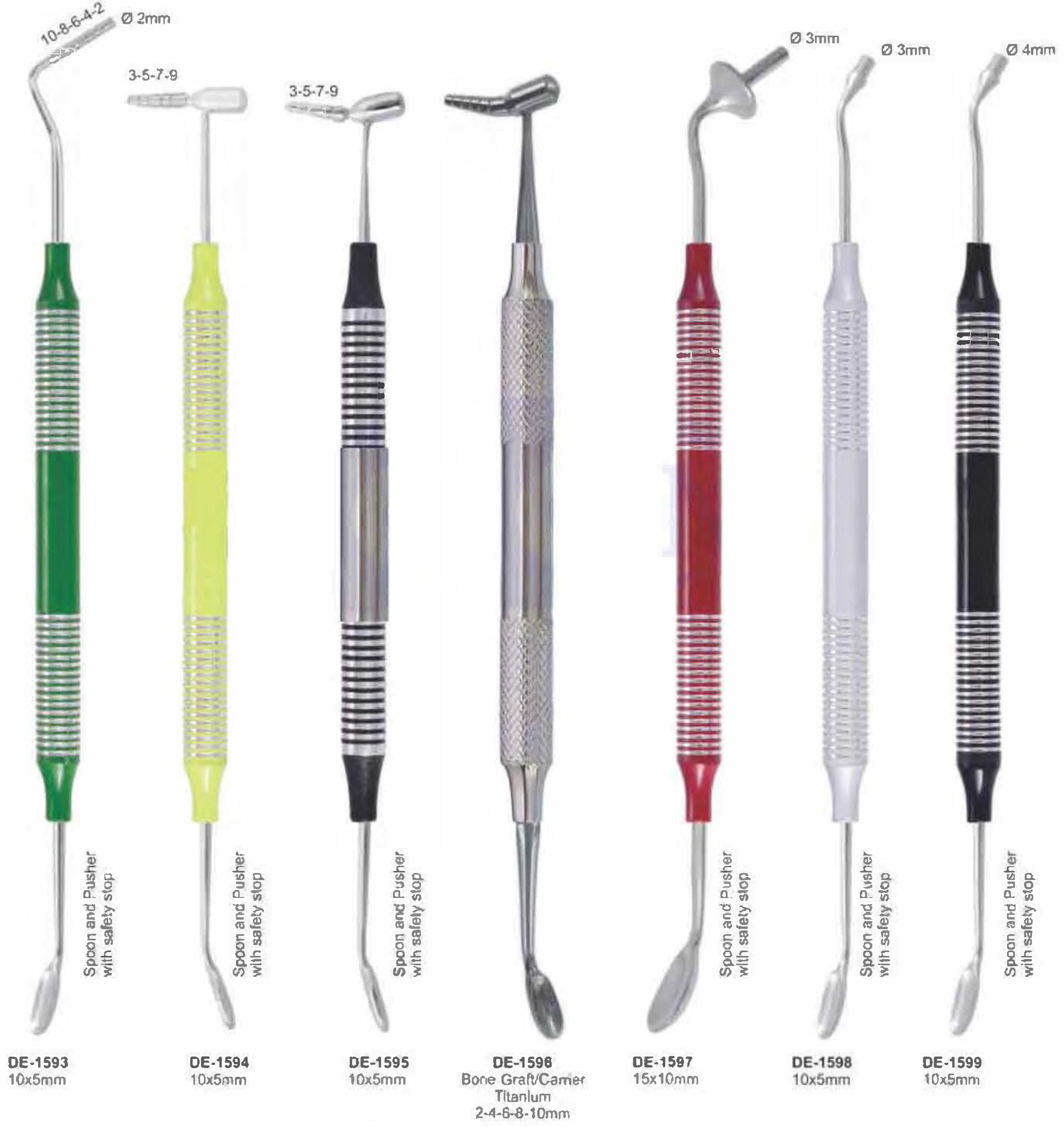

DE-1593
10x5mm

Spoon and Pusher
with safety stop

DE-1594
10x5mm

Spoon and Pusher
with safety stop

DE-1595
10x5mm

Spoon and Pusher
with safety stop

DE-1596
Bone Graft/Carver
Titanium
2-4-6-8-10mm

DE-1597
15x10mm

Spoon and Pusher
with safety stop

DE-1598
10x5mm

Spoon and Pusher
with safety stop

DE-1599
10x5mm

Spoon and Pusher
with safety stop

- Инструменты для имплантологии
 - Implantologie
 - Implantologie
- Инструменти для имплантології
 - Implantologia
 - زراعة الأسنان

PERIOSTEALS ELEVATOR 10mm Hollow Handle



DE-1600
Raspator,
BonexScraper
Length 165 mm,
10 mm hollow
handle,
double-ended 6
mm / 4 mm,

DE-1601
Raspator,
Raspatory
Length 180 mm,
10 mm hollow
handle,
double-ended
3 mm | 3 mm,

DE-1602
Raspator,
Raspatory
Length 180 mm,
10 mm hollow
handle,
double-ended
3 mm | 3 mm,

DE-1603
Raspator,
Papilla
Length 185 mm,
10 mm hollow
handle,
double-ended
3 mm | 2 mm,

DE-1604
Raspator,
bone scraper
Length 175 mm,
10 mm hollow
handle,
double-ended,

DE-1605
Raspator,
micro-Freer
Length 180 mm,
6 mm solid grip,
double-ended
3 mm | 4 mm

DE-1606
Raspator,
Freer
Length 180 mm,
6 mm solid
handle,
double-ended
5 mm | 5 mm,

- Инструменты для имплантологии
- Implantologie
- Implantologie

- Инструменти для имплантологї
- Implantologia
- زراعة الاسنان

PERIOSTEALS ELEVATOR 10mm Hollow Handle



DE-1607
Raspator,
Freer
10 mm hollow
handle,
high-quality
medical
double ended

DE-1608
Raspator,
Molt
Length 180 mm,
8 mm solid
grip,
double-ended
6 mm

DE-1609
Raspator,
micro Freer
Length 185 mm,
10 mm hollow
handle,
double-ended,

DE-1610
Raspator,
micro Freer
Length 185 mm,
10 mm hollow
handle,
double-ended,

DE-1611
Raspator, micro
Raspator /
chisel
Length 170 mm,
10 mm hollow
handle,
double-ended,

DE-1612
Raspator, micro
Raspator /
chisel
Length 175 mm,
10 mm hollow
handle,
double-ended,

DE-1613
Raspator,
Micro Raspator /
chisel
Length 175 mm,
8 mm solid handle,
double-ended
3.5mm | 3.5 mm,

- Инструменты для имплантологии
 - Implantologie
 - Implantologie
- Инструменти для имплантології
 - implantologia
 - زراعة الأسنان

PERIOSTEALS ELEVATOR 10mm Hollow Handle



DE-1614
Raspatory Micro Molt
Length 175 mm,
corrosion-resistant

DE-1615
Raspatory Chipping
Workers:
Chisel 24G and 7.5 mm,
length about 175 mm,
corrosion-resistant

DE-1616
Raspatory MOLT
Work ends;
5.0 mm and 4.0 mm,
length about 175 mm,
corrosion-resistant

DE-1617
Rasp, Molt M9
Length 175 mm,
corrosion-resistant

DE-1618
Raspator, WAUTIER
Length 175 mm,
corrosion-resistant

DE-1619
Raspator, BENQUE
Length 170 mm,
workers
5 mm | 7 mm,
corrosion-resistant

DE-1620
Raspator, Nordberg
Length 180 mm,
8 mm hollow handle,
double-ended
6 mm | 4 mm

- Инструменты для имплантологии
- Implantologie
- Implantologie
- زراعة الأسنان
- Implants
- Implants

Hollow Handle 10mm Length 170mm



DE-1621 Miller



DE-1622 Miller



DE-1623 LUCAS #84



DE-1624 LUCAS #85



DE-1625 LUCAS #86



DE-1626 LUCAS #87



DE-1627 LUCAS #88



DE-1628 LUCAS86S
SERRATED



DE-1629 LUCAS86AS
SERRATED

- Инструменты для имплантологии
 - Implantologie
 - Implantologie
- Инструменти для имплантології
 - Implantologia
 - زراعة الأسنان

TISSUE MEMBRANE FORCEPS



DE-1630
Tissue Graft Forcep
Serrated Teeth



DE-1631
Self Locking
Grooved



DE-1632
Tissue Graft Forcep
Serrated Teeth



DE-1633
Titanium
Locking Plier



DE-1634
TC Gripper Carbide
Tipped Tissue Forceps
Serrated Carbide Tips
14.5cm



DE-1635
Adson Carbide
Tipped Tissue Forceps
Serrated Carbide Tips
12cm



DE-1636
Micor Adson 1x2
Tissue Forcep 12.1cm
1x2 Teeth - 0.5mm Tips



DE-1637
Adson 7x7
Tissue Forceps
7x7 Teeth 12cm



DE-1638
Adson 7x7 Curved
Tissue Forceps
7x7 Teeth 12cm



DE-1639
Suture Pliers
Suture Forceps with
1.6mm Ring Tip



DE-1640
Debakey Atraumatic
Tissue Forceps Straight
Serrated Teeth
16cm



DE-1641
Debakey Atraumatic
Tissue Forceps Curved
Serrated Teeth
16cm



- Инструменты для имплантологии
- Instrumenti для имплантології
- Implantologie
- İmplantolojia
- Implantologie
- زراعة الأسنان

TISSUE MEMBRANE FORCEPS



DE-1642
Russian Long
Tissue Forceps
Serrated Tip
20cm



DE-1643
Russian
Tissue Forceps
Serrated Tip
15cm



DE-1644
Tissue Punch Forceps
To Remove Tissue
After Using Punch



DE-1645
13.5 cm
narrow



DE-1646
10.5 cm
Membrane tweezers **KUEHNE**



DE-1647
13.5 cm
wide



DE-1648
Pin-Tweezers
with or without lock,
length 15 cm,
with lock



DE-1649
without lock,



DE-1650
Haltepinzette with lock
15.5 cm, for pins, towards
the tips, etc.,



DE-1651
Carry Forceps
15cm



DE-1652
Carry Forceps
15cm



DE-1653
Carry Forceps
15cm



- Инструменты для имплантологии
 - Implantologie
 - Implantologie
- Инструменти для имплантології
 - Implantologia
 - زراعة الأسنان

OSTEOTOME CONVEXES / CONCAVE / CONIQUES

CONVEXES



DE-1654
SET OF 5 PIECES

CONCAVES







DE-1655
SET OF 5 PIECES

CONIQUES

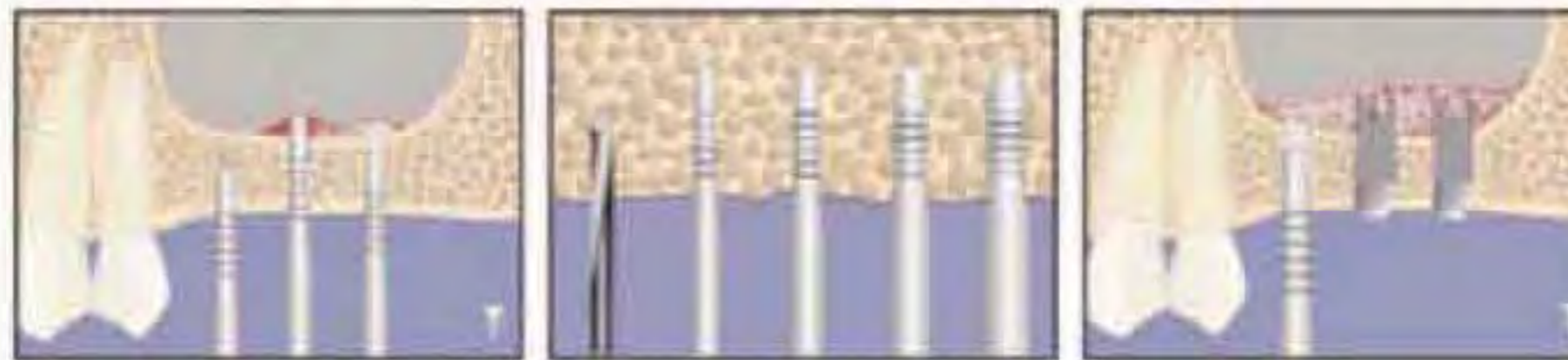

DE-1656
SET OF 5 PIECES



	CONVEXES STRAIGHT	DE-1654	2,7 Ømm	3,2 Ømm	3,7 Ømm	4,2 Ømm	5 Ømm
	CONCAVES STRAIGHT	DE-1655	2,7 Ømm	3,2 Ømm	3,7 Ømm	4,2 Ømm	5 Ømm
	CONIQUES STRAIGHT	DE-1656	2,7 Ømm	3,2 Ømm	3,7 Ømm	4,2 Ømm	5 Ømm



- Инструменты для имплантологии
- Implantsologie
- Implantologie
- Instruments for Implantology
- İmplantoloji
- زراعة الأسنان

OSTEOTOME CONVEXES / CONCAVE / CONIQUES

CONVEXES



**DE-1657
SET OF 5 PIECES**

CONCAVES



**DE-1658
SET OF 5 PIECES**

CONIQUES



**DE-1659
SET OF 5 PIECES**

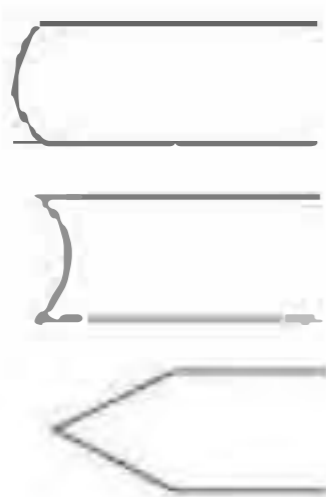
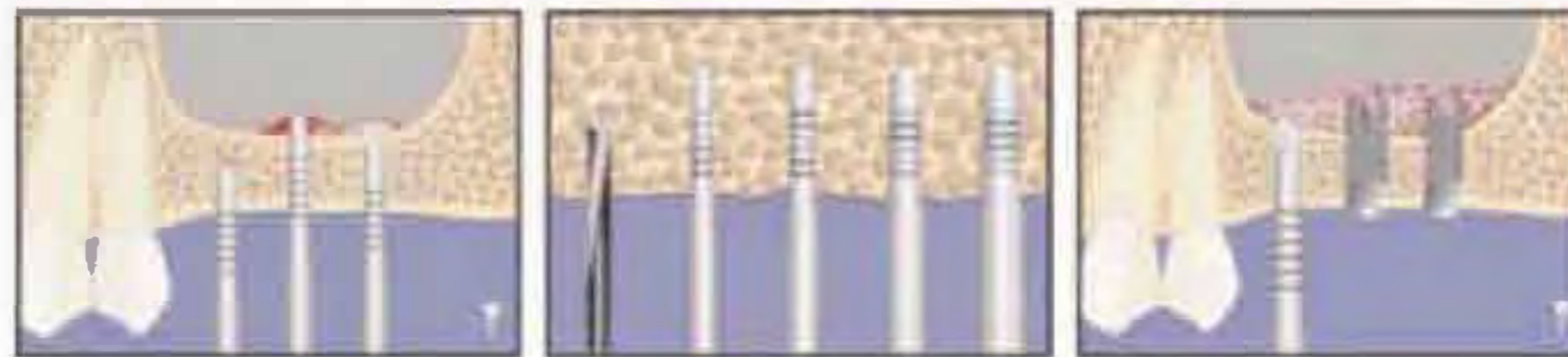

CONVEXES CURVED	DE-1657	2,7 Ømm	3,2 Ømm	3,7 Ømm	4,2 Ømm	5 Ømm
CONCAVES CURVED	DE-1658	2,7 Ømm	3,2 Ømm	3,7 Ømm	4,2 Ømm	5 Ømm
CONIQUES CURVED	DE-1659	2,7 Ømm	3,2 Ømm	3,7 Ømm	4,2 Ømm	5 Ømm



IMPLANTOLOGY

- Инструменты для имплантологии
- Implantologie
- Implantologie

- Инструменти для имплантології
- Implantologia
- زراعة الأسنان

TREPINE

Burs with depth markings are suited for precise and simple transplantation of cylindrical bone grafts as well as for all other bone-extraction tasks.



DE-1669
Tissue Punch with pin
Set of Four Pieces



DE-1670
Tissue Punch
Set of Five Pieces



DE-1671
Tissue Punch
Set of Five Pieces



DE-1672
Trephine Drill
Set of Eight Pieces



DE-1673
Short Implant Drills

DE-1674
Long Implant Drills



DE-1675
Trephine Drill
Set of Eight Pieces



- Инструменты для имплантологии
 - Implantologie
 - Implantologie
- Инструменти для имплантології
 - implantologia
 - زراعة الأسنان

BONE SCRAPER STRAIGHT & CURVED



DE-1676
Bone Scraper
Straight

DE-1677
Bone Scraper
Curved

TISSUE PUNCH STRAIGHT & CURVED



DE-1678
Tissue Punch
Straight



DE-1685
Tissue Punch
Curved

● DE-1679 2.0mm	● DE-1680 4.0mm	● DE-1686 2.0mm	● DE-1687 4.0mm
● DE-1681 5.0mm	● DE-1682 6.0mm	● DE-1688 5.0mm	● DE-1689 6.0mm
● DE-1683 7.0mm	● DE-1684 8.0mm	● DE-1690 7.0mm	● DE-1691 8.0mm



DE-1692
Bone Mill



DE-1693
Basins For Bone



BONE CRUSHER
DE-1694



- Инструменты для имплантологии
 - Implantologie
 - Implantologie
- Инструменти для имплантології
 - implantologia
 - زراعة الأسنان

KEYS FOR IMPLANT SCREW



DE-1695

DE-1696

DE-1697

DE-1698

TORQUE WRENCH & RATCHET



DE-1699 Star Torque Wrench 6.35mm Universal



DE-1700 Round Torque Wrench 4.0mm Universal



DE-1701 Hex Driver With 4.0mm Driver



DE-1702 Star Torque Wrench 6.35mm Universal



DE-1703 Hex Torque Wrench 4.00mm Universal



DE-1704 Star Torque Wrench 6.35mm Universal



DE-1705 Star Torque Wrench 6.35mm Universal



DE-1706 Star Torque Wrench 6.35mm Universal



DE-1707 Star Torque Wrench 6.35mm Universal



DE-1708 Star Torque Wrench 6.35mm Universal



DE-1709 Star Ratchet Wrench 6.35mm Universal



DE-1710 Star Ratchet Wrench 6.35mm Universal



DE-1711 Star Ratchet Wrench 6.35mm Universal



DE-1712 Star Ratchet Wrench 4.0mm Universal



DE-1713 Round Ratchet Wrench 4.0mm Universal



DE-1714 Round Ratchet Wrench 3.35mm Universal



DE-1715 Star Ratchet Wrench 4.0mm Universal



DE-1716 Star Ratchet Wrench 6.35mm Universal



- Инструменты для имплантологии
- Instrumenti для имплантологї
- Implantologie
- Implantologia
- زراعة الاسنان



DE-1717
BONE CRUSHER
Titanium Metal Cutter

mallet



DE-1718
BONE CRUSHER
Titanium Metal Cutter

mallet



DE-1719
BONE CRUSHER



DE-1720
BONE CRUSHER
Bone Grinding Grain
1.5mm, 2mm, 2.5mm



DE-1721
BONE CRUSHER
Bone Grinding Grain
1.5mm, 2mm, 2.5mm



- Инструменты для имплантологии
 - Implantologie
 - Implantologie
- Инструменти для имплантології
 - Implantologia
 - زراعة الأسنان

BONE EXPANDER SCREW & SURGICAL KITS



DE-1722
 Bone Universal Kit
 Drill: 2mm, 2.8mm, 3.2mm, 3.65mm,
 4.2mm, 4.5mm, 4.8mm, 5.2mm
 Trephines Bit:
 3.0mm, 4.0mm, 5.0mm, 6.0mm,
 7.0mm, 8.0mm, 9.0mm, 10mm.
 Driver:
 2.5mm, 2.5mm Hand Pcs
 1.25mm, 1.25mm Hand Pcs
 Short Driver 2.5mm
 Long Driver 2.5mm
 1.25mm, Short Hex Driver Hand Pcs
 1.25mm, Long Hex Driver Hand Pcs
 Torque Wrench 4.0mm



DE-1723
 Bone Expander Kit
 Expander: 2.6mm, 3.0mm,
 3.4mm, 3.8mm, 4.3mm
 Ratchet Driver
 Parallel Pin
 Pilot Drill
 Drill 1.4mm
 Drill Driver 4mm
 Hand Driver 4mm
 Ratchet 4.0mm



DE-1724
 Bone Universal Kit
 Drill: 2mm, 2.8mm, 3.2mm, 3.65mm,
 4.2mm, 4.5mm, 4.8mm, 5.2mm
 Trephines Bit:
 3.0mm, 4.0mm, 5.0mm, 6.0mm,
 7.0mm, 8.0mm, 9.0mm, 10mm.

Bone Compression:
 2mm, 3.3mm, 2.8mm, 4.2mm, 3mm, 3.5mm
 Driver:
 2.5mm, 2.5mm Hand Pcs
 1.25mm, 1.25mm Hand Pcs
 Short Driver 2.5mm
 Long Driver 2.5mm
 1.25mm, Short Hex Driver Hand Pcs
 1.25mm, Long Hex Driver Hand Pcs
 Torque Wrench 6.35mm 1 Pcs



DE-1725
 Conical Drills: 20 Pcs
 Tissue Punches:
 3.0mm, 3.5mm, 4.0mm, 4.5mm,
 5.0mm, 6.0mm, 6.50mm
 Bone Expander:
 1.6/3.8mm, 1.9/3.0mm, 2.1/3.6mm,
 2.6/3.8mm, 2.9/4.3mm
 Drill Adapter: 1 Pcs
 1.25mm, 2.50mm Hex Driver Hand Pcs

Pilot Drill: 1.6mm
 Drill Bit: 1.4mm, 1.6mm, 1.8mm, 2.0mm, 2.2mm
 Ratchet Driver: 4mm/6.35, 1.25/2.50
 Rimer: 3.2/4.7mm, 3.7/4.7mm
 Parallel Pin: 4.5mm, 2.5mm
 Double step Drill: 2.4/2.8mm
 Depth Gauge: 1 Pcs
 Torque Wrench 6.35mm Universal: 1 Pcs

INCHES
 0 1 2 3 4 5 6 7 8 9

- Инструменты для имплантологии
- Instrumenti для имплантології
- Implantologie
- İmplantolojia
- Implantologie
- زراعة الأسنان

BONE INJECTORS, COLLECTORS & SUCTION TUBE



DE-1726
Ø 2,5mm / 3,5mm / 170mm

DE-1727
Ø 4,5mm / 5,5mm / 170mm

DE-1728
Ø 3,5mm / 4,5mm / 170mm

DE-1729
Ø 6,0mm / 7,0mm / 170mm



DE-1730
18cm
Straight / Bend
I.D 2.5mm
O.D 3.5

DE-1731
18cm
Straight / Bend
I.D 3.5mm
O.D 4.5

DE-1732
18cm
Straight / Bend
I.D 4.5mm
O.D 5.5

DE-1733
18cm
Straight / Bend
I.D 6.0mm
O.D 7.0



DE-1734
17.5cm

DE-1735
18cm

DE-1736
coarse
Ø 5mm

DE-1737
fine
Ø 9mm

Suction tubes to collect the extracted bone material 180mm



DE-1738
Suction Tubes
180mm

DE-1739
Suction Tubes
180mm

DE-1740
Suction Tubes
180mm



DE-1741
Fig. 6FR
Frazier
15 cm - Ø 2 mm

DE-1742
Ø 3 mm
length 180mm

DE-1743
Ø 4 mm
length 180mm

DE-1744
Ø 5 mm
length 180mm

IMPRESSION TRAYS

- Оптичные ложки
- Porte-empreinte
- Abdrucklöffel
- Відбиткові ложки
- Cubetas para impresiones
- صواني الاطباق

PERFORATED WITH RIM LOCK
Set of 06 Pcs

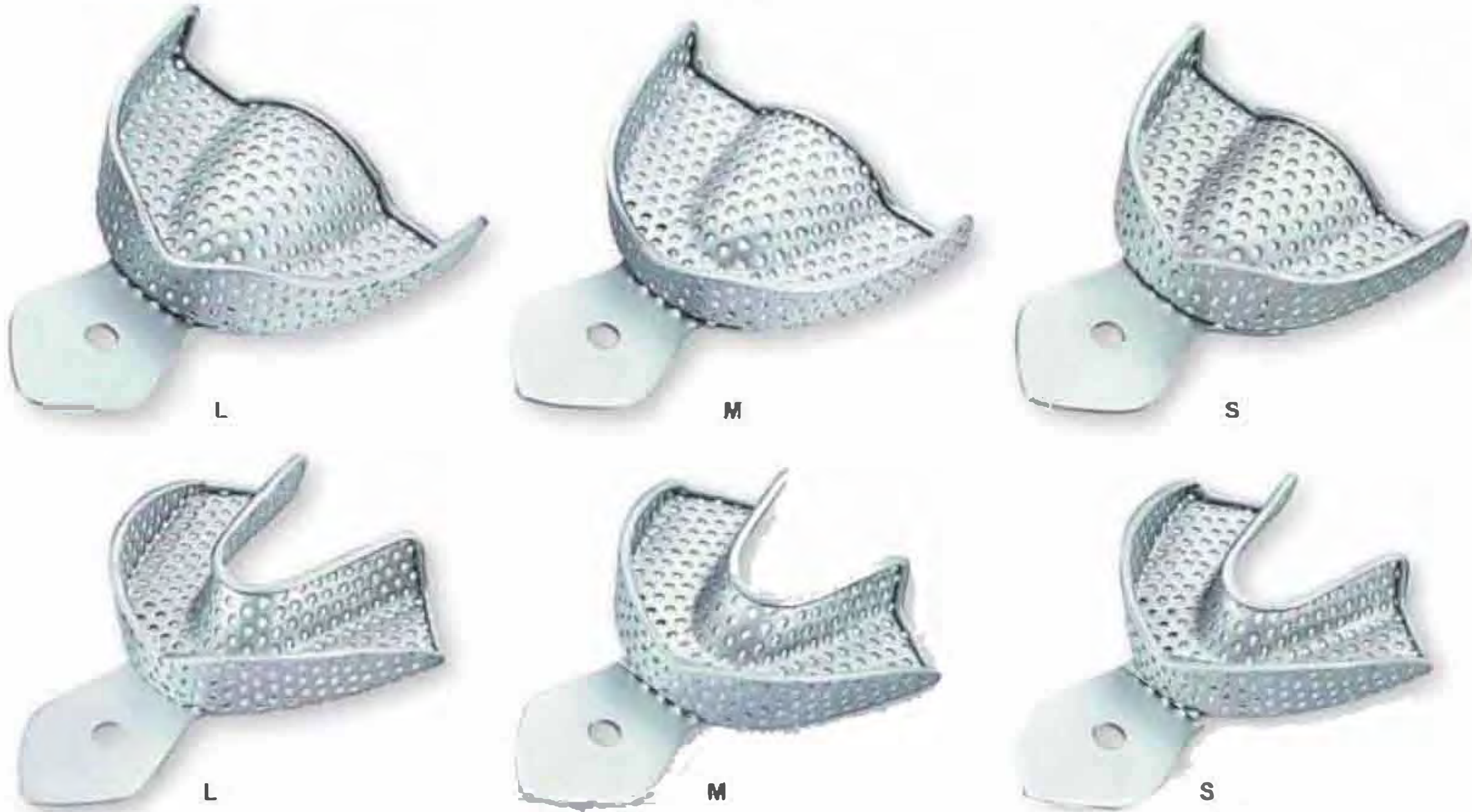

DE-1745 SET OF 08 PCS
Upper: S, M, L
Lower: S, M, L

PERFORATED WITH RIM LOCK
Set of 8 Pcs



DE-1746 SET OF 08 PCS
Upper: XS, S, M, L
Lower: XS, S, M, L

DE-1747 SET OF 08 PCS
Upper: S, M, L, XL
Lower: S, M, L, XL

DE-1748 SET OF 10 PCS
Upper: XS, S, M, L, XL
Lower: XS, S, M, L, XL



- Оттисковые ложки
- Відбиткові ложки
- Porte-empreinta
- Cubetas para Impresiones
- Abdrucklöffel
- صواني الانطباع

SOLID WITH RIM LOCK
Set of 6 Pcs



DE-1749 SET OF 06 PCS
Upper: S, M, L
Lower: S, M, L

SOLID WITH RIM LOCK
Set of 8 Pcs



DE-1750 SET OF 08 PCS
Upper: XS, S, M, L
Lower: XS, S, M, L

DE-1751 SET OF 08 PCS
Upper: S, M, L, XL
Lower: S, M, L, XL

DE-1752 SET OF 10 PCS
Upper: XS, S, M, L, XL
Lower: XS, S, M, L, XL



IMPRESSION TRAYS

- Оптичные ложки
- Porte-empainte
- Abdrucklöffel
- Відбиткові ложки
- Cubetas para impresiones
- صواني الاطباق

PERFORATED FULL DENTURE

Set of 8 Pcs

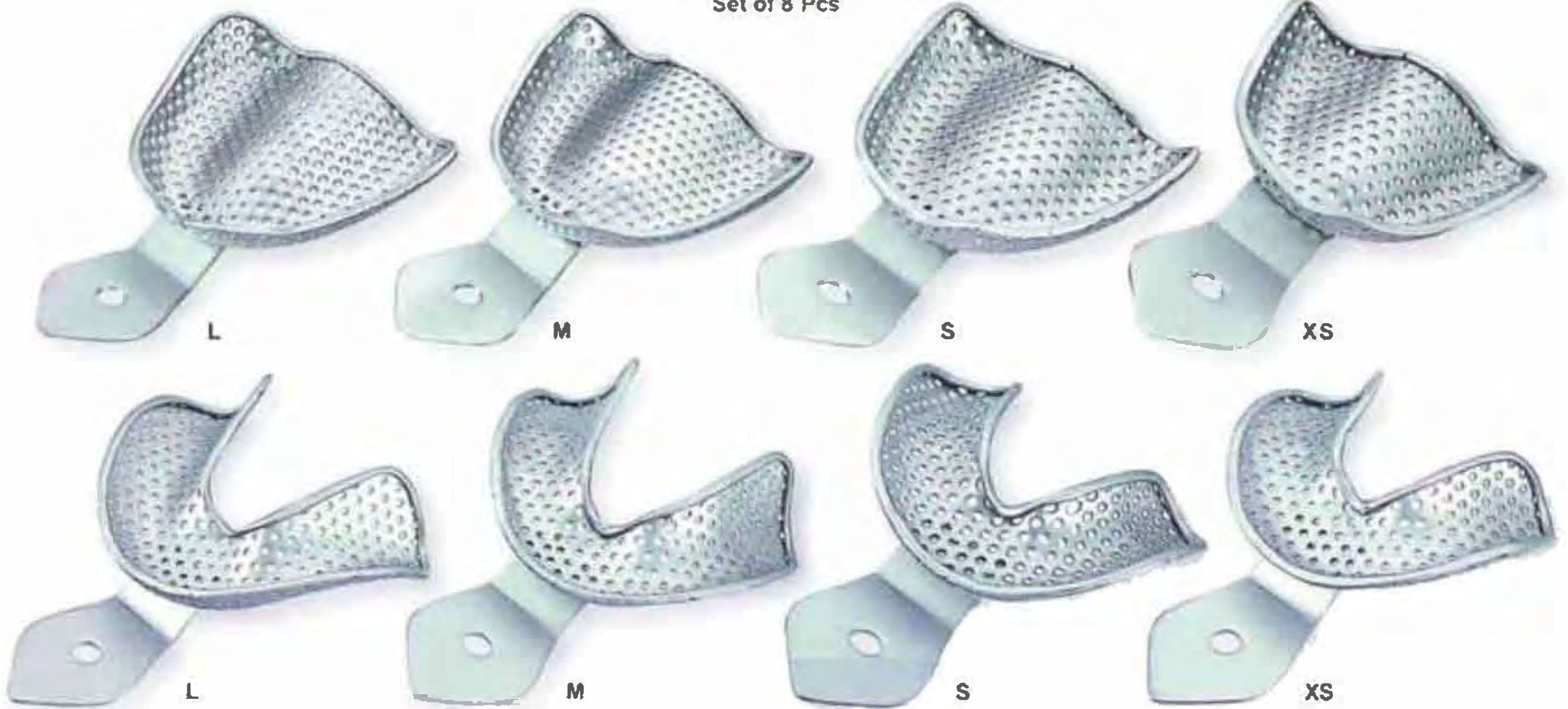

DE-1753 SET OF 08 PCS
Upper: S, M, L, XL
Lower: S, M, L, XL

DE-1754 SET OF 08 PCS
Upper: S, M, L
Lower: S, M, L

SOLID FULL DENTURE

Set of 8 Pcs

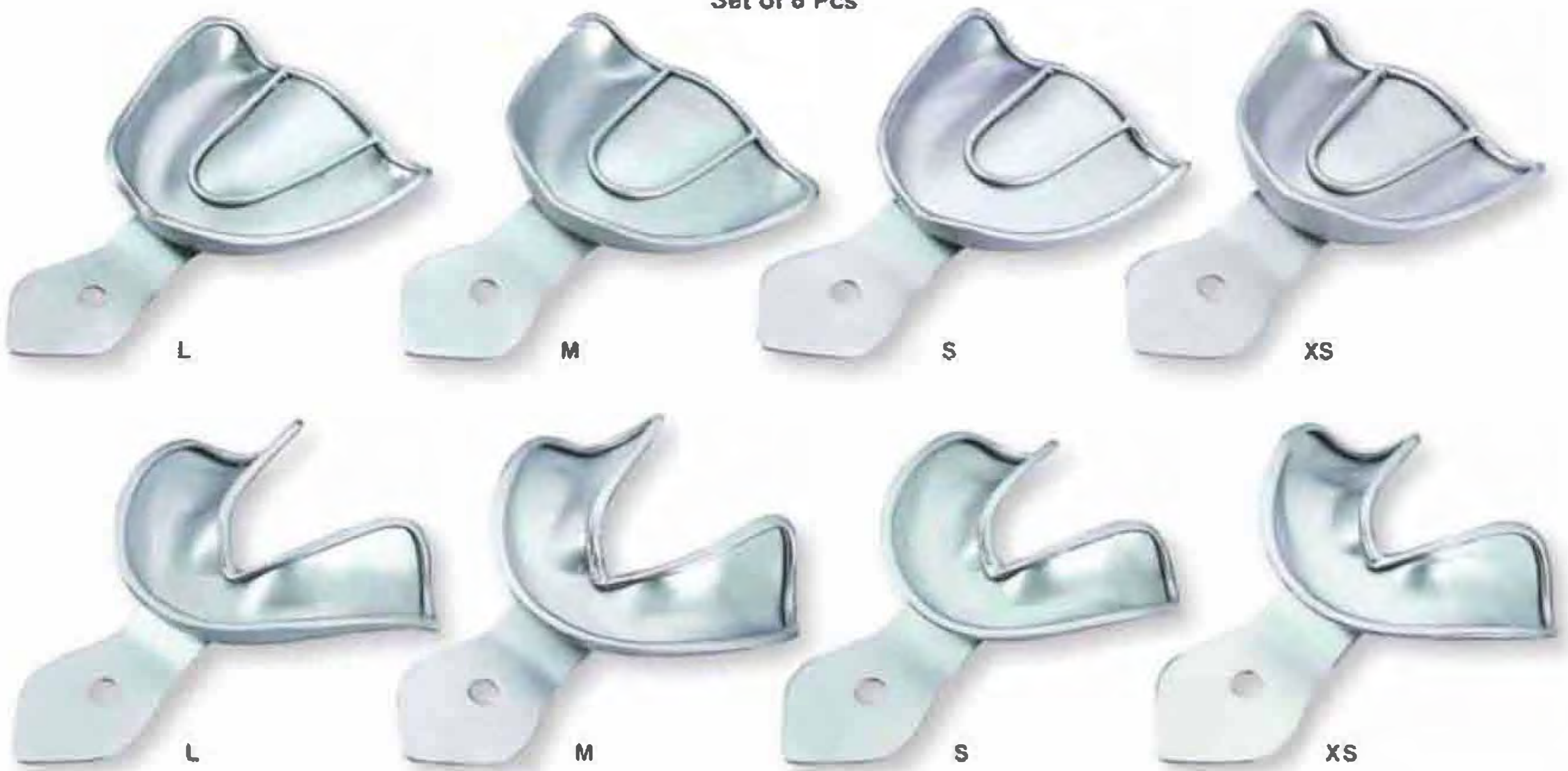

DE-1755 SET OF 08 PCS
Upper: S, M, L, XL
Lower: S, M, L, XL

DE-1756 SET OF 08 PCS
Upper: S, M, L
Lower: S, M, L



- Оттисковые ложки
- Відбиткові ложки
- Porte-empreinta
- Cubetas para Impresiones
- Abdrucklöffel
- صواني الانطباع

Perforated Without Rim Lock

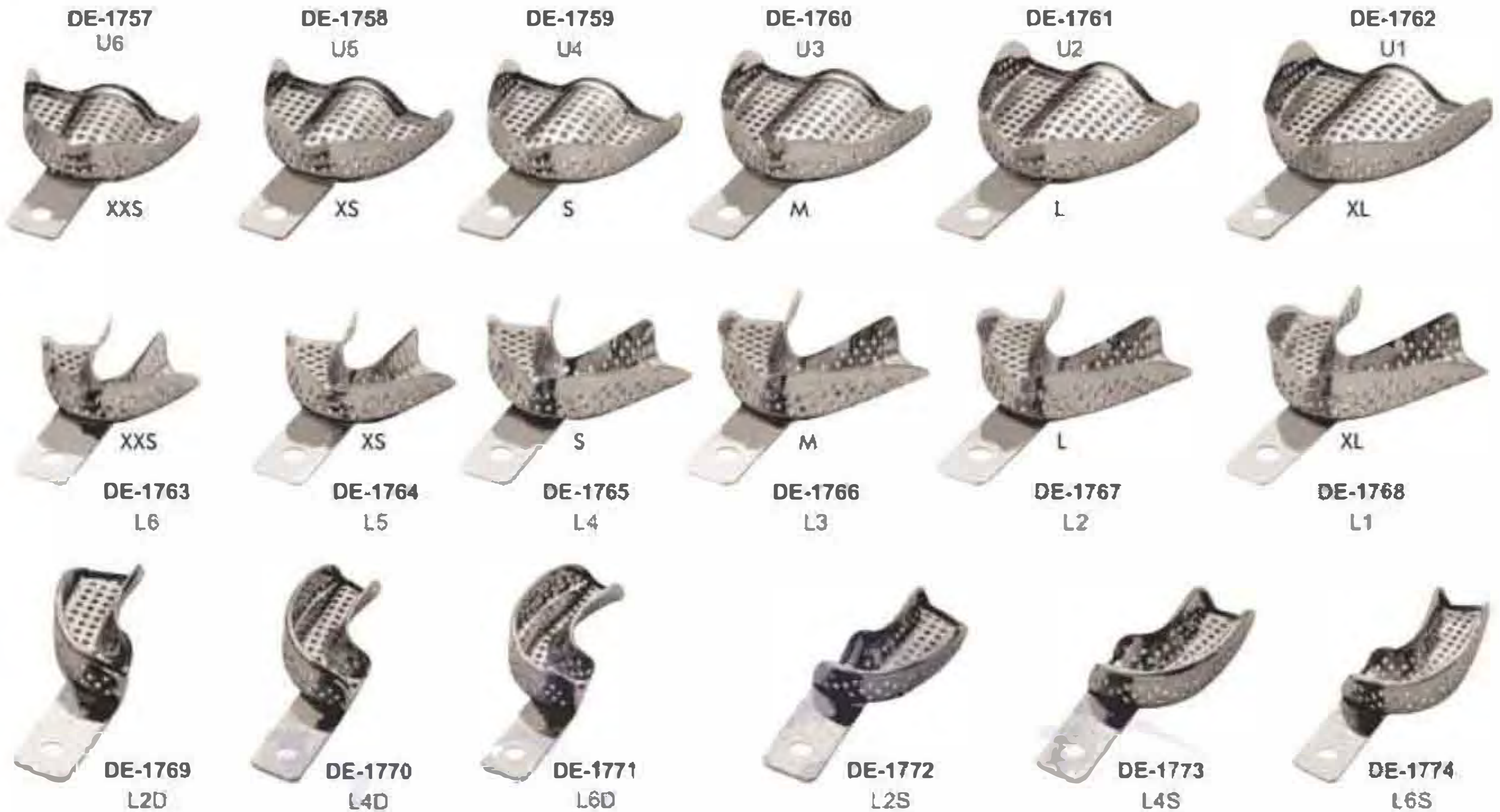

Solid With Rim Lock

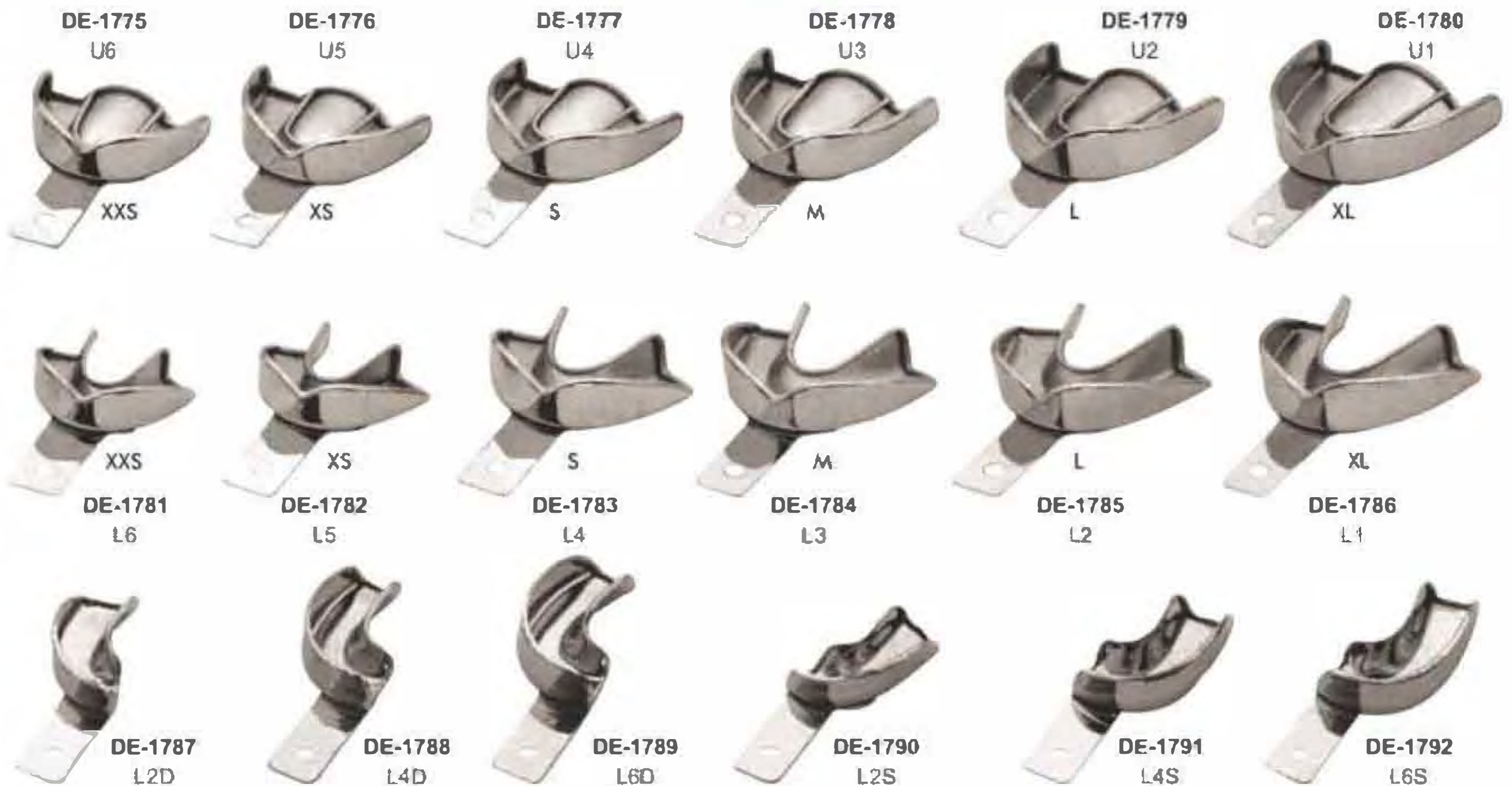



DE-1793
Instruments Cassettes
5 Pieces, 7 Pieces, 10 Pieces & 20 Pieces



DE-1794
Instruments Cassettes
5 Pieces, 7 Pieces, 10 Pieces & 20 Pieces



DE-1795
Instruments Cassette
7 Pieces & 10 Pieces



DE-1796
Gracey Curette Set Cassettes



DE-1797
182 x 150 x 20 mm
10 Instruments



DE-1798
180 x 85 x 15 mm
5 Instruments



DE-1799
288 x 182 x 35 mm
20 Instruments



DE-1800
288 x 182 x 35 mm
20 Instruments



DE-1801
182 x 145 x 35 mm
10 Instruments



DE-1802
182 x 72 x 35 mm
5 Instruments

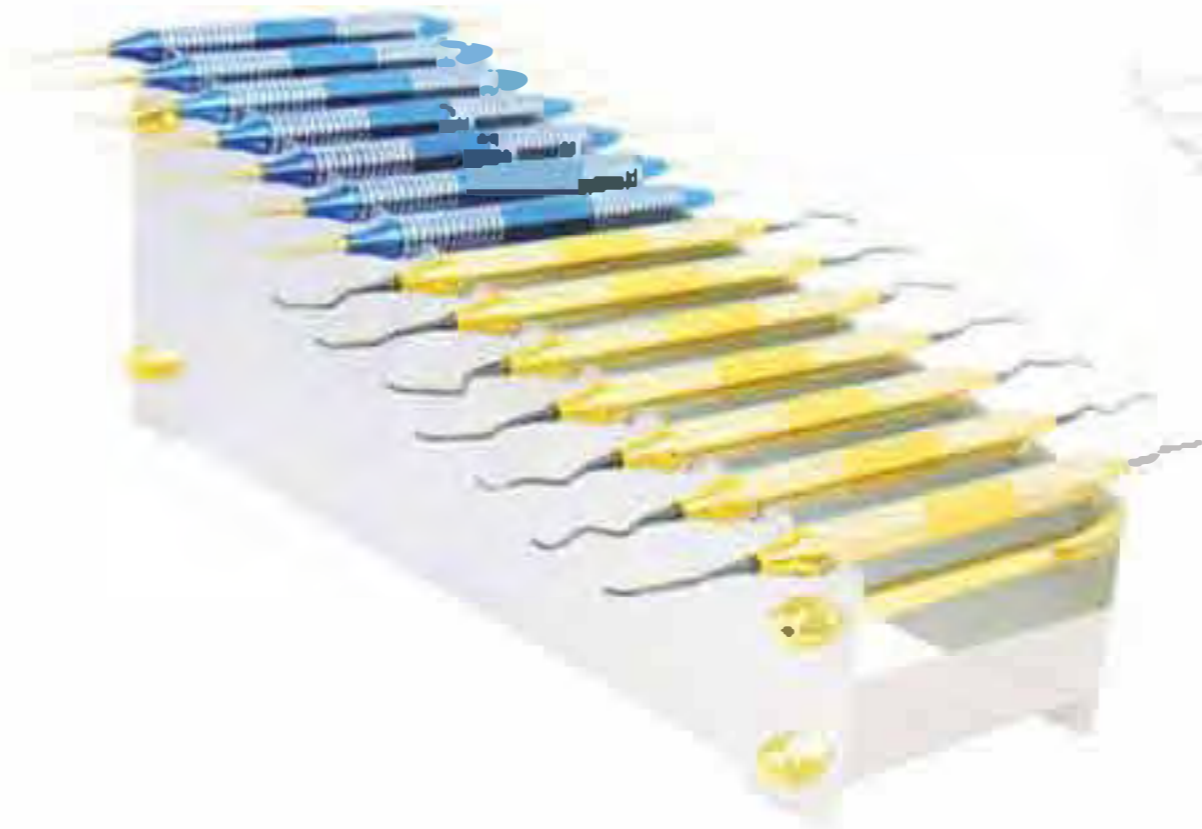

DE-1804
Gracey Curette Set Stand



DE-1803
182 x 145 x 35 mm
9 Instruments

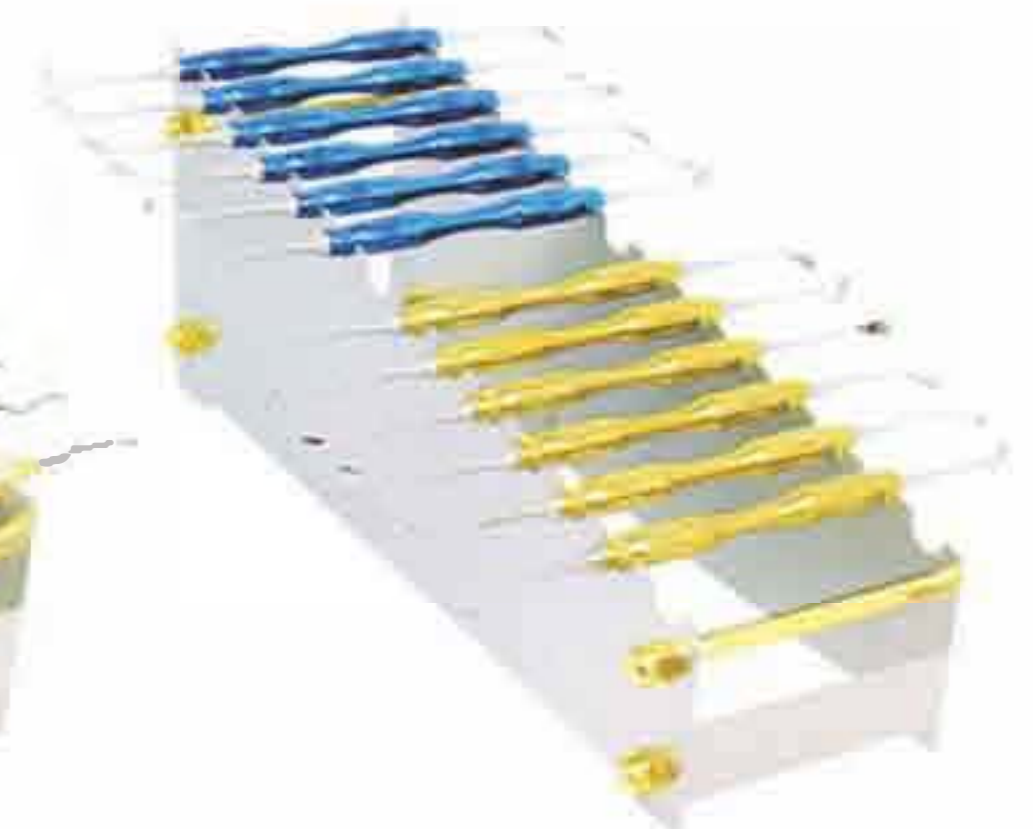

DE-1805
Sinus Lift Set Stand



Made of 18/8 stainless steel



KIDNEY TRAY WITH COVER
(English Pattern)

	Size
DE-1806	150 mm
DE-1807	200 mm
DE-1808	240mm
DE-1809	300 mm



Kidney Trays

With lid available	Without lid available
DE-1810 6"	DE-1814 6"
DE-1811 8"	DE-1815 8"
DE-1812 10"	DE-1816 10"
DE-1813 12"	DE-1817 12"



Deep	
DE-1818	2.25" - 2"
DE-1819	4.75" - 2"
DE-1820	5.5" - 2.5"
DE-1821	6.25" - 2.75"
DE-1822	7" - 3.5"



Sterilizing Drum

Art #	Ø mm	h mm
DE-1823	80	80
DE-1824	120	120
DE-1825	160	120
DE-1826	190	140
DE-1827	190	200
DE-1828	240	120
DE-1829	240	160
DE-1830	240	240
DE-1831	290	120
DE-1832	290	160
DE-1833	290	240
DE-1834	340	160
DE-1835	340	240
DE-1836	390	145
DE-1837	390	200
DE-1838	390	290



Cotton Holder -
DE-1839



Spirit Lamp
DE-1840



DE-1841
Endodontic Box



Forcep Jar	
DE-1842	25 x 80mm
DE-1843	30 x 100mm
DE-1844	100 x 200mm
DE-1845	75 x 173mm



DE-1846 6" x 8"
DE-1847 8" x 10"
DE-1848 10" x 12"
Without Lid



DE-1849
Instruments Box



SCALER TRAY
DE-1850
100 x 200 mm

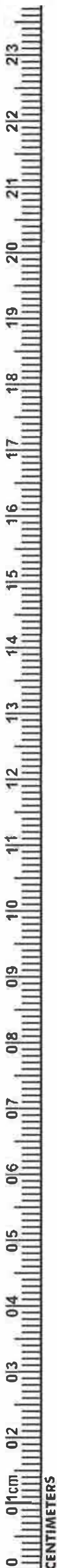

DESCRIPTION	PAGE #	DESCRIPTION	PAGE #	DESCRIPTION	PAGE #
3 PRONG CLASP ADJUSTABLE PLIER TC.....	107	CARVERS FILLING INSTRUMENTS.....	69	FLAT NOSE PLIER WITH SERRATION.....	105
ACORN FILLING INSTRUMENTS.....	52	CARVERS INSTRUMENTS.....	73	FLOHR ROOT ELEVATORS.....	20
ADAM PLIER WITH TC.....	102	CARVERS.....	71	FLUCH-CUT DISTAL AND CUTTING PLIERS.....	100
ADAMS PLIER ROUND BOX.....	100	CASTROVIEJO NEEDLE HOLDERS.....	86	FOERSTER DRESSING FORCEPS.....	148
ADAMS PLIERS FOR BENDING WIRE.....	100	CASTROVIEJO SCISSORS.....	84	FORCEP JAR.....	148
ADAMS, SMALL WIRE BENDING AND LOOP FORMING PLIERS.....	99	CEMENT SPATULAS.....	75	FREEDMAN "DUCKHEAD" IMPLANTOLOGY INSTRUMENTS.....	112
ADERER FACEBOW LOOP FORMING PLIERS.....	101	CHEEK RETRACTOR LONG.....	80	FREEDMAN BURNISHERS IMPLANTOLOGY INSTRUMENTS.....	112
ADERER LARGE WIRE BENDING AND LOOP FORMING PLIERS.....	100	CHEEK RETRACTOR.....	78	FREER PERIOSTEEL ELEVATORS.....	95
ADERER PLIER.....	101	CHEEK RETRACTORS, MINNESOTA.....	80	FRIEDMAN BONE ROUNGER.....	14
ADSON BROWN TWEEZERS.....	32	CHEEK RETRACTORS, RETRACTOR IVORY.....	80	FRIEDMANN ROOTS ELEVATOR.....	21
ADSON CARBIDE TIPPED TISSUE FORCEPS.....	133	CHEEK RETRACTORS, TONGUE DEPRESSORS.....	80	GAUGE FOR MEASURING.....	109
ADSON NEEDLE HOLDERS.....	86	CHISELS HOES FILLING INSTRUMENTS.....	74	GERALD TWEEZERS.....	31
ADSON TWEEZERS.....	32	CLAMP, OSTEO METER.....	109	GILLES TWEEZERS.....	31
ADSON-TC TWEEZERS.....	32	CLAPPISON/FRAHAM RESTORATIVE INSTRUMENTS.....	70	GILLIES NEEDLE HOLDER WITH SCISSORS.....	36
ALLEN PERIOSTEEL ELEVATORS.....	95	CLAW-LIFT ROOTS ELEVATOR.....	22	GOLDMAN FOX EXPLORERS.....	36
ALLIS 4:5 HAEMOSTATIC FORCEPS.....	87	COHEN UNIVERSAL FORCEPS.....	10-11	GOLDMAN FOX MERRIT B EXPLORERS.....	36
ALLIS-BABY 3:4 HAEMOSTATIC FORCEPS.....	87	COLLEGE CURVED.....	32	GOLDMAN FOX UNIVERSITY OF MICHIGAN EXPLORERS.....	36
AMALGAM CARVERS.....	56-57, 70-71	COLLEGE TWEezer.....	32	GOLDMAN FOX WILLIAMS EXPLORERS.....	36
AMALGAM FILES.....	71	COLLEGE WITH LOCK TWEEZERS.....	31	GOLDMAN PERIODONTAL INSTRUMENTS.....	58
AMALGAM INSTRUMENTS & SCALPEL HANDLES.....	92	COLLINS TONGUE FORCEPS.....	32	GOLDMAN-FOX PERIOSTEEL ELEVATORS.....	95
AMALGAM INSTRUMENTS.....	93	COMPOSITE/PLASTIC FILLING INSTRUMENTS.....	49-50, 54	GOLDMAN-FOX SCISSORS.....	83-84
AMALGAM WELL MATRIX RETAINERS.....	91	CONDENSER INSTRUMENTS.....	118	GOLDMAN-FOX SET.....	61
AMALGAM WELL.....	93	CONDENSER MORTONSON FILLING INSTRUMENTS.....	50	GOLDSTEIN INTERPROXIMAL EXCAVATOR.....	67
ANATOMICAL CARVER.....	71	CONTOURING INSTRUMENT IMPLANTOLOGY INSTRUMENTS.....	111	GRACEY AFTER FIVE.....	42
ANDREW RESTORATIVE INSTRUMENTS.....	70	CONTOURING PLIER.....	101	GRACEY CURETTE INSTRUMENTS.....	62
ANGLE FORMERS.....	72	COSMETIC CONTOURING.....	113	GRACEY CURETTE SET CASSETTES.....	147
ANGLED DIRECT BOND BRACKET REMOVER TC.....	106	COTTON HOLDER.....	148	GRACEY CURETTE.....	43
ANISWORTH CLAMPS FORCEPS.....	88	COUPLAND ROOT ELEVATORS.....	17	GRACEY MINI FIVE.....	42
ANTERIOR FILLING INSTRUMENTS.....	68	COUPLAND ROOT ELEVATORS.....	18	GRACEY PERIODONTAL INSTRUMENTS.....	39
ANTERIOR.....	47	CRANE KAPLAN TWEEZERS.....	32	GRACEY SET OF 7 PCS.....	40-41
APEXO ROOT ELEVATORS.....	15-19	CRANE-KAPLAN PERIODONTAL INSTRUMENTS.....	59	GRAFT PACKER, CONCAVE TIPS.....	125
APICAL ROOT ELEVATORS.....	19	CRILE NEEDLE HOLDERS.....	85	GREGG IMPLANTOLOGY INSTRUMENTS.....	111
ARCH FORMING PLIERS.....	104	CRILE-WOOD NEEDLE HOLDERS.....	85-86	GRITMAN CEMENT SPATULAS.....	75
ARTICULATORS.....	77	CROWN AND BAND CONTOURING PLIERS.....	105	GROSS MAIER DRESSING FORCEPS.....	107
A-TRAUMATIC EXTRACTION SET.....	03	CROWN REMOVER.....	90	GUM SCISSORS.....	87
ATRAUMATIC TWEEZERS.....	31	CROWN SPREADERS.....	90	HAEMOSTATIC FORCEPS & TOWEL CLAMPS.....	87
BACK ACTION FILLING INSTRUMENTS.....	52	CRYER EXTRACTING FORCEPS.....	10	HALSEY NEEDLE HOLDERS.....	85-86
BACKHAUS HAEMOSTATIC FORCEPS.....	87	CRYER ROOTS ELEVATOR.....	23	HALSTEAD MOSQUITO HAEMOSTATIC FORCEPS.....	87
BACOLITE HANDLE WAX KNIVES.....	76	CURETTE COLUMBIA.....	43	HALSTEAD MOSQUITO NEEDLE HOLDERS.....	86
BALDWIN FILLING INSTRUMENTS.....	49	CURETTE INSTRUMENTS.....	63	HALTEPINZETTE WITH LOCK.....	134
BALL FILLING INSTRUMENTS.....	52	CURETTE MCCALL.....	43	HAMMER HEAD TIE BACK PLIER.....	104
BALL HOOK CRIMPING PLIER.....	105	CURETTE.....	60	HANDLES FOR MOUTH MIRRORS.....	30
BAND PUSHER.....	90	CURETTES SET OF 8 PIECES.....	43	HARD WIRE CUTTERS.....	107
BAND REMOVING PLIER.....	99	CURETTES.....	40-43, 61-62	HARRIS EXTRACTING FORCEPS.....	11
BAND SEATER AUTO CLEAVABLE.....	97	CUTTING INS PERIODONTAL INSTRUMENTS.....	39	HARTMANN (BABY MOSQUITO) NEEDLE HOLDERS.....	86
BAND SEATING PLIER.....	104	DARBY-PERRY EXCAVATORS.....	65	HATCHETS FILLING INSTRUMENTS.....	68
BANDS & CROWNS PLIERS.....	101	DE LA ROSA PLIERS WITH GROOVED.....	105	HEAT CARRIERS.....	46
BASINS FOR BONE.....	138	DE LA ROSA PLIERS.....	105	HEBER ROOTS ELEVATOR.....	24
BAUMGARTER NEEDLE HOLDERS.....	85	DEAN SCISSORS.....	84	HEIDBRINK ROOT ELEVATORS.....	20-21, 26
BAUMGARTNER NEEDLE HOLDERS.....	86	DEBAKEY ATRAUMATIC TISSUE FORCEPS.....	133	HEIDMANN PERIODONTAL INSTRUMENTS.....	39
BAYONET ROOTS ELEVATOR SET.....	21	DEEP BOWL.....	148	HEMINGWAY CURETTE INSTRUMENTS.....	63
BEAVERTAIL FILLING INSTRUMENTS.....	52	DEEP ROOT PICK FORCEPS (APICAL SET OF 9).....	04	HEMINGWAY TWEEZERS.....	32
BEEBEE NEEDLE HOLDERS.....	85	DELICATE NEEDLE HOLDERS.....	85	HOES.....	71
BEIN ROOT ELEVATORS.....	15-16, 24	DELUXE BRACKET HOLDER TWEEZERS.....	96	HOLLANBACK PERIODONTAL INSTRUMENTS.....	39
BEYER BONE ROUNGER.....	14	DENHARD CHEEK RETRACTORS.....	79	HOLLENBACK FILLING INSTRUMENTS.....	50
BINANGLE FILLING INSTRUMENTS.....	74	DENTAL MIRROR PERIODONTAL INSTRUMENTS.....	39	HOLLENBACK IMPLANTOLOGY INSTRUMENTS.....	114
BIRD BEAK ANGLED BENDING PLIER.....	103	DENTAL SYRINGES.....	13	HOLLENBACK RESTORATIVE INSTRUMENTS.....	70
BIRD BEAK PLIER WITH TC.....	102	DERF NEEDLE HOLDERS.....	85	HOLLOW HANDLE.....	132
BIRD BEAK WIRE BENDING & CUTTING PLIERS.....	101	DERF NEEDLE HOLDERS.....	86	HOLLOW WARE.....	148
BIRD BEAK WIRE BENDING PLIER.....	100	DIRECT BOND BRACKET HOLDER TWEEZERS.....	96	HOLLOWCHOP CONTOURING PLIERS.....	106
BIRD BEAK WITH CUTTER PLIERS.....	104	DIRECT BONDING BRACKET HOLDERS.....	96	HOOK CRIMPING PLIER ANGLED STRAIGHT TC.....	107
BLACK FILLING INSTRUMENTS.....	50	DIRECT BONDING BRACKET REMOVER PLIER TC.....	106	HOOK KNIVES.....	76
BLACK TITANIUM COLOUR COATED INSTRUMENTS.....	110-111	DIRECT BRACKET REMOVER TC.....	107	HOW PLIER CURVED WITH TC.....	103
BLADE AND PUSHER.....	126	DISCOID-CLEOID CARVER.....	71	HOW PLIER CURVED.....	99, 104
BLUMENTHAL BONE ROUNGER.....	14	DISTAL END CUTTER REGULAR WITH T.C.....	102	HOW PLIER STRAIGHT WITH TC.....	103
BOGHOSIAN FILLING INSTRUMENTS.....	49	DISTAL END CUTTER, SAFETY HOLD PLIER.....	107	HOW PLIER STRAIGHT.....	103
BOGHOSIAN IMPLANTOLOGY INSTRUMENTS.....	111	(IDEAL FOR CUTTING WIRE) TC.....	107	HOWARD PERIOSTEEL ELEVATORS.....	95
BOLEY GAUGE.....	109	DISTAL END, WIRE CUTTERS & BRACKET REMOVER PLIERS.....	107	HYGIENIST PERIODONTAL INSTRUMENTS.....	58
BONE BRACKET GAUGE.....	96	DOUBLE ENDED CEMENT SPATULA.....	98	HYGIENIST-JACQUETTE PERIODONTAL INSTRUMENTS.....	58
BONE CARRIER TITANIUM.....	124	DRESSING TWEEZERS.....	31-32	HYGIENIST-TOWNER PERIODONTAL INSTRUMENTS.....	58
BONE CRUSHER.....	138, 140	ELASTIC SEPARATING PLIER.....	107	HYLIN CEMENT SPATULAS.....	75
BONE EXPANDER SCREW & SURGICAL KITS.....	141	ELASTOMERIC LIGATURE PLACING FORCEPS.....	107	HYLIN ROOTS ELEVATOR.....	23
BONE FILES.....	94	WITH GROOVE FALCON.....	107	IMPLANT GAGES.....	108
BONE GRAFT/CARRIER TITANIUM.....	128	ELLIOT MATRIX RETAINERS.....	91	IMPLANT SINUS LIFT INSTRUMENTS.....	117, 122
BONE GRAFTING INSTRUMENTS COMPACTOR/TAMPERS.....	125	ENDED CHEEK RETRACTORS.....	79	IMPLANT.....	123
BONE GRAFTING INSTRUMENTS.....	126-127	ENDODONTIC BOX.....	148	IMPLANTOLOGY IMPLANTOLOGY INSTRUMENTS.....	112
BONE INJECTORS, COLLECTORS & SUCTION TUBE.....	142	ENDODONTICS INSTRUMENTS.....	47	IMPLANTOLOGY INSTRUMENTS.....	111
BONE MILL.....	138	ENGLISH PATTERN KLEIN #3 PEDODONTIC UNIVERSAL FORCEPS.....	08	IMPLANTOLOGY.....	109-110
BONE ROUNGER.....	14	EXAMINATION KIT SET OF 3 PIECES.....	34	IMPRESSION TRAYS.....	143-146
BONE SCRAPER STRAIGHT & CURVED.....	138	EXAMINATION SET OF 4 PIECES.....	34	INSTRUMENTS BOX.....	148
BONE SPOON/PACKER.....	125	EXAVATORS.....	37	INSTRUMENTS CASSETTES & STANDS.....	147
BONE THICKNESS GAUGE.....	109	EXCAVATOR PERIODONTAL INSTRUMENTS.....	39	INTERPROXIMAL CARVER IMPLANTOLOGY INSTRUMENTS.....	111
BONE UNIVERSAL KIT.....	141	EXCAVATORS INSTRUMENTS SET OF 11 PIECES.....	57	INTERPROXIMAL OFF-ANGLE FILLING INSTRUMENTS.....	49
BRACKET REMOVER ANGULATED PLIER.....	103	EXCAVATORS INSTRUMENTS.....	64-67	INTRALIGAMENTAL ANESTHESIA SYRINGE.....	13
BRACKET REMOVER PLIER STRAIGHT.....	103	EXCAVATORS.....	64	IRIS SCISSORS.....	83-84
BRACKET REMOVER PLIERS ANGLED WITH T.C.....	102	EXPLORER PERIODONTAL INSTRUMENTS.....	39	IVORY LIGHT WEIGHT CLAMPS FORCEPS.....	88
BRACKET REMOVER PLIERS STRAIGHT WITH T.C.....	102	EXPLORERS INSTRUMENTS.....	35	IVORY MATRIX RETAINERS.....	91
BRACKET REMOVING PLIER ROUND BOX.....	99	EXPLORERS.....	33-45	IWANSON SPRING CALIPER.....	109
BRACKET REMOVING PLIER.....	99	EXTRACTING FORCEPS (AMERICAN PATTERN).....	10-14	JACQUETTE SCALERS PERIODONTAL INSTRUMENTS.....	59
BREWER CLAMPS FORCEPS.....	88	EXTRACTING FORCEPS (ENGLISH PATTERN).....	01-02, 05-07	JARA BEAK PLIER.....	104
BURNISHER FILLING INSTRUMENTS.....	49	EXTRA-FLEX IMPLANTOLOGY INSTRUMENTS.....	114	JENNINGS CHEEK RETRACTORS.....	79
BURNISHER FILLING INSTRUMENTS.....	54	FALCON BEAK CONTOURING PLIERS.....	100	JOHNSON CONTOURING PLIERS.....	100
BURNISHER UNIVERSITY OF MICHIGAN AMALGAM CARVERS.....	56	FARABEUF RETRACTOR.....	82	JONES HAEMOSTATIC FORCEPS.....	87
BURNISHERS FILLING INSTRUMENTS.....	52-53	FELDMAN RETRACTOR.....	82	JOSEPH SCISSORS.....	84
BURNISHERS IMPLANTOLOGY INSTRUMENTS.....	112	FILES FILLING INSTRUMENTS.....	53	KELLY HAEMOSTATIC FORCEPS.....	87
BUSER PERIOSTEEL ELEVATORS.....	95	FILLING INS PERIODONTAL INSTRUMENTS.....	39	KELLY SCISSORS.....	83-84
CARRY FORCEPS.....	134	FILLING INSTRUMENTS.....	37, 44, 49-55, 69, 72	KELLY-RANKIN HAEMOSTATIC FORCEPS.....	87
CARVER HOLLENBACK AMALGAM CARVERS.....	56	FLAT NOSE PLIER SMOOTH.....	105	KEYS FOR IMPLANT SCREW.....	139

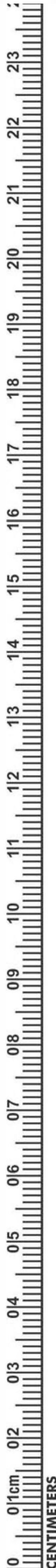

DESCRIPTION	PAGE #	DESCRIPTION	PAGE #	DESCRIPTION	PAGE #
KIDNEY TRAY WITH COVER (ENGLISH PATTERN)	148	ORTHO LIGHT SCALER HEAVY	97	SINUS LIFT INSTRUMENT	118-121
KIDNEY TRAYS	148	ORTHO LIGHT SCALER SINGLE ENDED	98	SINUS LIFT SET STAND	147
KILNER (RAGNELL) SCISSORS	84	ORTHO LIGHT SCALER	97	SINUS WINDOW BONE TAMPERS	127
KLEINERT-KUTZ BONE ROUNGER	14	ORTHODONTIC INSTRUMENTS	96-98	SINUSLIFT INSTRUMENTS	118
KOPP ROOTS ELEVATOR	23-24	ORTHOLITE LIGATURE DIRECTOR SCALER	98	SIQVELAND RETAINERS TOFFLEMIRE-JUNIER MATRIX RETAINERS	91
KRARNER-NEVINS BONE CHISEL	94	OSTEOMETER MEASURING FORCEPS	96	SMAHA ELASTOMERIC LIGATURE PLACING FORCEPS	107
LA GRANGE SCISSORS	83-84	OSTEOTOME CONVEXES / CONCAVE / CONIQUES	135-136	SPENCER SCISSORS	84
LADMORE FILLING INSTRUMENTS	52	OVAL SPOONS/DARBY-PERRY	65	SPIRIT LAMP	148
LADMORE IMPLANTOLOGY INSTRUMENTS	112	P.K. THOMAS WAXING INSTRUMENTS	73	SPOON AND PUSHER (TRINOVO)	128
LAP-JOINT THREE PRONG PLIER	106	PALATAL ARCH PLIER	105	SPOON AND PUSHER WITH SAFETY STOP	128
LAXUTOR ROOT ELEVATORS	19	PALMER CLAMPS FORCEPZ	88	SPOONS	64
LE CRON CEMENT SPATULAS	75	PDL ELEVATORS	28-29	SPREADERS	46
LESSMANN	76	PEDIATRIC TOOTH EXTRACTING FORCEPS SET	09	STANDARD LIGATURE CUTTER TC	106
LIGATURE FORMING PLIERS	101	PERIODONTAL FILLING INSTRUMENTS	53	STEP PLIERS WITH TC	103
LIGHT WIRE BIRD BEAK LONG PLIER WITH TC	102	PERIODONTAL INSTRUMENTS	37, 39, 58, 60, 95	STERILIZING DRUM	148
LIGHT WIRE BIRD BEAK LONG PLIER	104	PERIODONTAL PROBES	46, 48	STOP V BENDING PLIER	105
LIGHT WIRE BIRD BEAK PLIERS	104	PERIOSTEALS ELEVATOR	95, 129-130	STRAIGHT DIRECT BOND BRACKET REMOVER TC	107
LIGHT WIRE CUTTER MICRO WITH T.C.	102	PERIOTOME ROOTS ELEVATOR	26	SURGICAL CHISELS	123
LIGHT WIRE PLIER	104	PERRY TWEEZER	31-32	SURGICAL TWEEZERS	31
LINDO LEVIAN ROOT ELEVATORS	20	PESTERIOR BEND REMOVER PLIER LONG	103	SUTURE PLIERS SUTURE FORCEPS	133
LINGUAL / PALATAL ARCH FORMING PLIERS	101	PESTERIOR BEND REMOVER PLIER MEDIUM	103	SYNDESMOTOMES ROOTS ELEVATOR	26
LINGUAL PLIER LONG HANDLE	106	PESTERIOR BEND REMOVER PLIER SHORT	103	TAMPER	126
LINGUAL PLIER WEINGART	106	PIN & LIGATURE CUTTERS TC	106	TANNER FILLING INSTRUMENTS	52, 69
LINGUAL WEINGART PLIER	106	PIN HOLDING PLIER TC	107	TANNER IMPLANTOLOGY INSTRUMENTS	114
LINING APPLICATOR DOUBLE END	55	PIN-TWEEZERS	134	TC GRIPPER CARBIDE	133
LOCKLIN SCISSORS	84	PLAIN MIRRORS	30	THARP RESTORATIVE INSTRUMENTS	70
LONDON COLLEGE TWEEZERS	31	PLASTER KNIFE 76 SPECIAL INOX	76	THREE PRONG PLIERS REGULAR	106
LORNA HAEMOSTATIC FORCEPS	87	PLIERS FOR ORTHODONTICS & PROSTHETICS	99-106	TISSUE GRAFT FORCEP SERRATED TEETH	133
LUCAS	132	PLUGER PERIODONTAL INSTRUMENTS	39	TISSUE MEMBRANE FORCEPS	132, 134
LUER BONE ROUNGER	14	PLUGGER BLACK AMALGAM CARVERS	56	TISSUE PUNCH FORCEPS	134
LUKS	47	PLUGGERS	45, 48	TISSUE PUNCH STRAIGHT & CURVED	138
LUXATOR ROOT ELEVATORS	15-16, 21	PLUGGERS/CONDENSERS FILLING INSTRUMENTS	50	TOFFLEMIRE-SENIOR MATRIX RETAINERS	91
LUXIER ROOTS ELEVATOR	22	PLUGGERS/CONDENSERS	51	TOFFLEMIRE-UNIVERSAL MATRIX RETAINERS	91
MAGNIFYING MIRRORS	30	POINTED CURETTE	60	TORQUE WRENCH & RATCHET	139
MANUAL CROWN REMOVER	90	POINTED PROBES SINGLE ENDED	36	TOWNER PERIODONTAL INSTRUMENTS	58
MARCOTTE LOOPING PLIER	105	POSTERIOR	48	TOWNER-JACQUETTE PERIODONTAL INSTRUMENTS	58
MARGIN TRIMMERS	72	POSTERIOR BAND REMOVER PLIERS	102	TREPINE DRILL SET OF EIGHT PIECES	137
MARGINAL RIDGE & EMBRASURE SHAPING INSTRUMENT	113	POTT ROOTS ELEVATOR	25	TUFTS FILLING INSTRUMENTS	49
MARKLEY PLUGGERS/CONDENSERS	51	POWER CROWN REMOVER LIFT	90	TUNNELIERUNGS INSTRUMENT	126
MARQUETTE FILLING INSTRUMENTS	50	PRICHARD PERIOSTEAL ELEVATORS	95	TWEED / ANGEL FORMING AND TORQUING PLIERS	101
MARYAM TWEEZERS	32	PROBES DOUBLE ENDED	35	TWEED / ANGLE RECTANGULAR ARCH FORMING & TORQUING PLIERS	100
MATHIEU NEEDLE HOLDERS	86	PROBES SINGLE ENDED	34	TWEED ARCH FORMING PLIER TC	102
MATRIX RETAINERS	91	QUÉTIN FILLING INSTRUMENTS	49	TWEED CUTTER PLIER	104
MAYO NEEDLE HOLDERS	85	RASPATOR, BENQUE	131	TWEED LOOP FORMIN PLIERS	100
MAYO SCISSORS	83	RASPATOR, FREER	129, 131	TWEED LOOP FORMING PLIER TC	105
MAYO-HEGAR NEEDLE HOLDERS	85-86	RASPATOR, MICRO FREER	131	TWEED LOOP FORMING PLIERS	99
MEAD 1A BONE ROUNGER	14	RASPATOR, MICRO RASPATOR / CHISEL	131	TWEED LOOP PLIER	104-105
MEAD BONE FILES	94	RASPATOR, MICRO-FREER	129	TWEEZER PERIODONTAL INSTRUMENTS	39
MEASURING LOOP	109	RASPATOR, NORDBERG	131	TWEEZERS	31
MEASURING LOOP, CASTROVIEJO	109	RASPATOR, PRICHARD	124	TWEEZERS	32
MEDIUM CEMENT CEMENT SPATULAS	75	RASPATOR, RASPATORY PERIOSTEAL ELEVATORS	95	TWEL-ON ELASTIC MODULE INSTRUMENT	97
MEDIUM PLACING/CONDENSING IMPLANTOLOGY INSTRUMENTS	114	RASPATOR, WAUTIER	131	UNIVERSAL DOLPHIN STYLE WIRE BENDING & CUTTING PLIERS	99
MEMBRANE POSITIONING INSTRUMENTS	118	RASPATOR, WILLIGER PERIOSTEAL ELEVATORS	95	UNIVERSAL FILLING INSTRUMENTS	49
MEMBRANE TWEEZERS KUEHNE	134	RASPATORY CHIPPING	131	UNIVERSAL FILLING INSTRUMENTS	54
MERIAM TWEEZERS	31	RASPATORY MICRO MOLT	131	UNIVERSAL NEEDLE HOLDERS	85
MERRIT A EXPLORERS	36	RASPATORY MOLT	131	UNIVERSITY OF MICHIGAN EXPLORERS	36
MERRIT B EXPLORERS	36	REGULAR TWEED ARCH FORMING PLIERS	104	UTILITY PLIER WEINGART TC	107
MERSHON CROWN REMOVER	90	RESTORATIVE INSTRUMENTS	51-53, 68, 70-72	V BEND STOP PLIER TC	106
METZENBAUM NEEDLE HOLDERS	85	RETRACTOR WITH ERGO GRIP	90	W. BARRY ROOTS ELEVATOR	25
METZENBAUM SCISSORS	83	RETRACTORS - MOUTH GAGS	78-79	WAHL BONE FILES	94
MICOR ADSON TISSUE FORCEP	133	RETRACTORS	80-82	WALDSAVHS WIRE BENDING AND CUTTING PLIERS	101
MICRO IRIS SCISSORS	83	RETRACTORS CHEEK RETRACTOR COMBINATION COMBINATION	80	WALL FILLING INSTRUMENTS	69
MICRO-FRIEDMAN BONE ROUNGER	14	RETRACTORS COMBINATION	81	WANGEN HOLDER	78
MILLER BONE FILES	94	RETRACTORS, LANGENBECK	82	WARD AMALGAM CARVERS	56
MILLER TWEEZERS	32	RETRACTORS, MINI-LANGENBECK	81	WARD FILLING INSTRUMENTS	69
MILLER	132	RETRACTORS, UNIQUE	81	WAX KNIVES	76
MINI LIGATURE CUTTERS	100	RETRO FILLING	48	WEDELSTAEDT	71
MINI PIN & LIGATURE CUTTER TC	106	REVERSED LIGATURE CUTTER ANGLED	102	WEINGART GENERAL UTILITY PLIER LONG MOUTH WITH TC	103
MIXING SPATULA WITH SHOVEL	124	RHODIUM MIRRORS	30	WEINGART PLIER MEDIUM	99-101
MODIED MCCALL	60	ROCHESTER-KOCHER 1X2 HAEMOSTATIC FORCEPS	87	WEINGART PLIER REGULAR WITH TC	103
MOLT BONE FILES	94	ROCHESTER-PEAN HAEMOSTATIC FORCEPS	87	WEINGART PLIER SLIM WITH TC	102
MOLT PERIOSTEAL ELEVATORS	95	ROOT ELEVATOR	15-29	WEINGART PLIER UNIVERSAL WITH TC	103
MORTONSEN FILLING INSTRUMENT	55	ROOT PLANNING FILES	94	WEINGART PLIER UTILITY WITH TC	103
MOUTH GAG MOLT	78	ROOT PLANNING FILES & BONE FILES	94	WEITLANDER CHEEK RETRACTORS	79
MOUTH MIRROR	37	ROOTS ELEVATOR	22	WEITLANER CHEEK RETRACTORS	79
MSY CEMENT SPATULAS	75	ROSER-KÖNIG CHEEK RETRACTORS	79	WERDELSTAEDT FILLING INSTRUMENTS	74
MULTIFUNCTIONAL METER	108	ROUND NOSE PLIER	104	WESTON CEMENT SPATULAS	75
NAKAWALNL DENTAL LABORATORY INSTRUMENTS	77	ROUNDED CONE	73	WIDE MATRIX RETAINERS	91
NANCE LOOP FORMING PLIERS	99	ROUNDED-CONE FILLING INSTRUMENTS	49	WILLIAM PROBE SET	38
NANCE PLIER	105	RUBBER DAM CLAMPS	89	WILLIAMS EXPLORERS	36
NARROW MATRIX RETAINERS	91	RUBBER DAM CLAMPS FORCEPS	89	WINGURT PLIER SLIM	105
NEEDLE HOLDERS	85-86	RUSSIAN LONG TISSUE FORCEPS	134	WINGURT UTILITY PLIER	105
NEUMANN SCISSORS	84	RUSSIAN TISSUE FORCEPS	134	WINTER ROOTS ELEVATOR	25
NOYES SCISSORS	84	SCALER TRAY	148	WIRE BENDING & LOOP FORMING PLIERS	99
OCCLUSAL ANATOMY INSTRUMENT	113	SCALER/CURETTE SETS	60	WISDOM ROOTS ELEVATOR	21
OHL PERIOSTEAL ELEVATORS	95	SCALER/CURETTE SETS INSTRUMENTS	61	WOODEN HANDLE	76
OLSEN-HEGAR NEEDLE HOLDER WITH SCISSORS	51	SCHURE BAND SEATER	97	WOODSON FILLING INSTRUMENTS	49
OREGON PLUGGERS/CONDENSERS	51	SEAPARATING ELASTIC PLIER	88	YOUNG PLIER WITH GROOVED	105
ORTHO BAND PUSHER SCALER	98	SELDIN PERIOSTEAL ELEVATORS	95	YOUNG TONGUE FORCEPS	99
ORTHO INSTRUMENT	97	SELDIN RETRACTOR	82	YOUNG WIRE BENDING & LOOP FORMING PLIERS	99
ORTHO LIGATURE DIRECTOR SINGLE ENDED	98	SELDIN ROOT ELEVATORS	15-18, 25	ZAHLE CEMENT SPATULAS	75
ORTHO LIGHT BAND PUSHER SCALER	97-98	SELF LOCKING GROOVED	133		
ORTHO LIGHT DOUBLE ENDED LIGATURE DIRECTOR SCALER	98	SELF-LOCKING TWEEZER	32		
ORTHO LIGHT DOUBLE ENDED LIGATURE DIRECTOR	98	SEMKEN TAYLOR TWEEZERS	31		
ORTHO LIGHT DOUBLE ENDED LIGATURE SCALER	98	SICKLE PERIODONTAL INSTRUMENTS	39		
ORTHO LIGHT DOUBLE ENDED LIGATURE SCALER/DIRECTOR	98	SICKLE SCALERS INSTRUMENTS	58		
ORTHO LIGHT LIGATURE DIRECTOR DOUBLE ENDED	98	SINGLE ENDED PROBE	33		
ORTHO LIGHT SCALER DOUBLE ENDED	97	SINUS LIFT ELEVATOR	115-116		

*High Quality
Instruments*



WhatsApp: +92 311 0545662



Email: sales@ribsintl.com

Extraction Sets
Extracting Forceps
Root Elevators
Bone Rongeurs
Orthodontic Pliers
Scalers
Impression Trays